

Trace back information:
Workspace 22B version a4
Checked in 2022-06-01
Skribenta version 5.5.019

Product manual

IRB 920T-6/0.45

IRB 920T-6/0.55

IRB 920T-6/0.65

OmniCore

Document ID: 3HAC075721-001

Revision: D

The information in this manual is subject to change without notice and should not be construed as a commitment by ABB. ABB assumes no responsibility for any errors that may appear in this manual.

Except as may be expressly stated anywhere in this manual, nothing herein shall be construed as any kind of guarantee or warranty by ABB for losses, damage to persons or property, fitness for a specific purpose or the like.

In no event shall ABB be liable for incidental or consequential damages arising from use of this manual and products described herein.

This manual and parts thereof must not be reproduced or copied without ABB's written permission.

Keep for future reference.

Additional copies of this manual may be obtained from ABB.

Original instructions.

© Copyright 2022 ABB. All rights reserved.
Specifications subject to change without notice.

Table of contents

Overview of this manual	9
Product documentation	11
How to read the product manual	13
1 Safety	15
1.1 Safety information	15
1.1.1 Limitation of liability	15
1.1.2 Requirements on personnel	16
1.2 Safety signals and symbols	17
1.2.1 Safety signals in the manual	17
1.2.2 Safety symbols on manipulator labels	19
1.3 Robot stopping functions	25
1.4 Safety during installation and commissioning	26
1.5 Safety during operation	29
1.6 Safety during maintenance and repair	30
1.6.1 Safety during maintenance and repair	30
1.6.2 Emergency release of the robot axes	33
1.6.3 Brake testing	34
1.7 Safety during troubleshooting	35
1.8 Safety during decommissioning	36
2 Manipulator description	37
2.1 About IRB 920	37
2.2 Technical data	38
2.3 Robot dimensions	41
2.4 Working range	44
2.5 Information labels	48
2.6 The unit is sensitive to ESD	49
3 Installation and commissioning	51
3.1 Introduction to installation and commissioning	51
3.2 Unpacking	52
3.2.1 Pre-installation procedure	52
3.2.2 Risk of tipping/stability	53
3.2.3 Transportation bracket	54
3.3 On-site installation	55
3.3.1 Brief installation procedure	55
3.3.2 Test run after installation, maintenance, or repair	56
3.3.3 Lifting the robot	57
3.3.3.1 Lifting the robot by two people	57
3.3.3.2 Lifting robot with lifting accessories	59
3.3.4 Manually releasing the brakes	63
3.3.5 Orienting and securing the robot	65
3.3.6 Loads fitted to the robot, stopping time and braking distances	68
3.3.7 Lamp	69
3.3.7.1 Lamp on the robot	69
3.3.7.2 Installation of signal lamp (option)	70
3.3.8 Fitting equipment on the robot (robot dimensions)	72
3.4 Restricting the working range	75
3.4.1 Adjusting the working range	75
3.4.2 Mechanically restricting the working range	76
3.5 Electrical connections	78
3.5.1 Robot cabling and connection points	78
3.5.2 Customer connections	81

Table of contents

4	Maintenance	85
4.1	Introduction	85
4.2	Service Information System (SIS)	86
4.3	Maintenance schedule and expected component life	87
4.3.1	Specification of maintenance intervals	87
4.3.2	Maintenance schedule	88
4.3.3	Expected component life	90
4.4	Inspection activities	91
4.4.1	Inspecting the information labels	91
4.4.2	Inspecting the robot cabling	93
4.4.3	Inspecting the ball screw spline unit	94
4.4.4	Inspecting axis-3 mechanical stops	97
4.4.5	Inspecting timing belts	100
4.5	Replacement/changing activities	105
4.6	Lubrication activities	106
4.6.1	Lubricating the ball screw spline unit	106
4.7	Cleaning activities	108
4.7.1	Cleaning the IRB 920	108
5	Repair	111
5.1	Introduction	111
5.2	General procedures	112
5.2.1	Performing a leak-down test	112
5.2.2	Mounting instructions for bearings	113
5.2.3	Mounting instructions for sealings	115
5.2.4	Cut the paint or surface on the robot before replacing parts	118
5.3	Cable harness	120
5.3.1	Replacing the main harness	120
5.3.2	Replacing the process hub	175
5.3.3	Replacing the SMB unit and battery unit	193
5.4	Base	203
5.4.1	Replacing the base	203
5.4.2	Replacing the axis-1 timing belt	266
5.5	Inner arm	325
5.5.1	Replacing the inner arm	325
5.6	Outer arm	398
5.6.1	Replacing the mechanical stopper	398
5.6.2	Replacing the bellows	421
5.6.3	Replacing the pulley on the ball screw upper position	436
5.6.4	Replacing the pulley on the ball screw lower position	454
5.6.5	Replacing the ball screw	488
5.6.6	Replacing the axis-2 timing belt	534
5.6.7	Replacing the axis-3 timing belt	565
5.6.8	Replacing the axis-4 second timing belt	579
5.6.9	Replacing the axis-4 timing belt	601
5.6.10	Replacing the transmission module	626
5.6.11	Replacing the outer arm	652
5.7	Motors	712
5.7.1	Replacing the axis-1 motor sub-assembly	712
5.7.2	Replacing the axis-2 motor sub-assembly	771
5.7.3	Replacing the axis-3 motor sub-assembly	802
5.7.4	Replacing the axis-4 motor sub-assembly	819
5.8	Gearboxes	843
5.8.1	Replacing the axis-1 gear unit sub-assembly	843
5.8.2	Replacing the axis-2 gear unit sub-assembly	906

6	Calibration	945
6.1	Introduction to calibration	945
6.1.1	Introduction and calibration terminology	945
6.1.2	Calibration methods	946
6.1.3	When to calibrate	948
6.2	Synchronization marks and axis movement directions	949
6.2.1	Synchronization marks and synchronization position for axes	949
6.2.2	Calibration movement directions for all axes	951
6.3	Updating revolution counters	952
6.3.1	Updating revolution counters on OmniCore robots	952
6.4	Calibrating with Axis Calibration method	956
6.4.1	Description of Axis Calibration	956
6.4.2	Calibration tools for Axis Calibration	959
6.4.3	Installation locations for the calibration tools	961
6.4.4	Axis Calibration - Running the calibration procedure	962
6.4.5	Reference calibration	966
6.5	Calibrating the robot	968
6.5.1	Calibration position	968
6.5.2	Calibrating axis 1 and axis 2	969
6.5.3	Calibrating axis 3 and axis 4	970
6.6	Verifying the calibration	975
6.7	Checking the synchronization position	976
7	Troubleshooting	977
7.1	Introduction to troubleshooting	977
7.2	Oil and grease stains on motors and gearboxes	979
7.3	Mechanical noise or dissonance	980
7.4	Manipulator collapses on power down	982
7.5	Motor temperature too high	983
8	Decommissioning	985
8.1	Introduction to decommissioning	985
8.2	Environmental information	986
8.3	Scrapping of robot	988
9	Reference information	989
9.1	Introduction	989
9.2	Applicable standards	990
9.3	Unit conversion	991
9.4	Screw joints	992
9.5	Weight specifications	995
9.6	Standard toolkit	996
9.7	Special tools	997
9.8	Lifting accessories and lifting instructions	999
10	Spare parts	1001
10.1	Spare part lists and illustrations	1001
	Index	1003

This page is intentionally left blank

Overview of this manual

About this manual

This manual contains instructions for:

- mechanical and electrical installation of the IRB 920
- maintenance of the IRB 920
- mechanical and electrical repair of the IRB 920

The robot described in this manual has the following protection types:

- *Standard*
 - *Clean Room*
-

Product manual scope

The manual covers all variants and designs of the IRB 920. Some variants and designs may have been removed from the business offer and are no longer available for purchase.

Usage

This manual should be used during:

- installation and commissioning, from lifting the product to its work site and securing it to the foundation, to making it ready for operation
- maintenance work
- repair work
- decommissioning work



Note

It is the responsibility of the integrator to conduct a risk assessment of the final application.

It is the responsibility of the integrator to provide safety and user guides for the robot system.

Who should read this manual?

This manual is intended for:

- installation personnel
 - maintenance personnel
 - repair personnel.
-

Prerequisites

A maintenance/repair/installation craftsman working with an ABB robot must:

- be trained by ABB and have the required knowledge of mechanical and electrical installation/repair/maintenance work.
 - be trained to respond to emergencies or abnormal situations.
-

Continues on next page

References

Documentation referred to in the manual, is listed in the table below.

Document name	Document ID
<i>Product manual, spare parts - IRB 920</i>	3HAC075722-001
<i>Product specification - IRB 920</i>	3HAC075723-001
<i>Circuit diagram - IRB 920</i>	3HAC075152-014
<i>Safety manual for robot - Manipulator and IRC5 or OmniCore controllerⁱ</i>	3HAC031045-001
<i>Product manual - OmniCore C30</i>	3HAC060860-001
<i>Product manual - OmniCore C90XT</i>	3HAC073706-001
<i>Product manual - OmniCore E10</i>	3HAC079399-001
<i>Operating manual - OmniCore</i>	3HAC065036-001
<i>Application manual - Controller software OmniCore</i>	3HAC066554-001
<i>Application manual - CalibWare Field</i>	3HAC030421-001
<i>Technical reference manual - Event logs for RobotWare 7</i>	3HAC066553-001
<i>Technical reference manual - Lubrication in gearboxes</i>	3HAC042927-001
<i>Technical reference manual - System parameters</i>	3HAC065041-001

ⁱ This manual contains all safety instructions from the product manuals for the manipulators and the controllers.

Revisions

Revision	Description
A	First edition.
B	Published in release 21D. The following updates are done in this revision: <ul style="list-style-type: none"> Updated signal lamp information, see Installation of signal lamp (option) on page 70. Supported controller OmniCore E10 is added.
C	Published in release 22A. The following updates are done in this revision: <ul style="list-style-type: none"> The protection type <i>Clean Room</i> and protection class IP54 are added throughout the manual. Added information about length of thread engagement for attachment screws. Added troubleshooting for high motor temperature, see Motor temperature too high on page 983. Updated information about Gleitmo treated screws, see Screw joints on page 992.
D	Published in release 22B. The following updates are done in this revision: <ul style="list-style-type: none"> Updated robot power cable information, see Robot cables on page 78. Added cleaning instructions for robots with protection type Clean Room.

Product documentation

Categories for user documentation from ABB Robotics

The user documentation from ABB Robotics is divided into a number of categories. This listing is based on the type of information in the documents, regardless of whether the products are standard or optional.



Tip

All documents can be found via myABB Business Portal, www.abb.com/myABB.

Product manuals

Manipulators, controllers, DressPack/SpotPack, and most other hardware is delivered with a **Product manual** that generally contains:

- Safety information.
 - Installation and commissioning (descriptions of mechanical installation or electrical connections).
 - Maintenance (descriptions of all required preventive maintenance procedures including intervals and expected life time of parts).
 - Repair (descriptions of all recommended repair procedures including spare parts).
 - Calibration.
 - Decommissioning.
 - Reference information (safety standards, unit conversions, screw joints, lists of tools).
 - Spare parts list with corresponding figures (or references to separate spare parts lists).
 - References to circuit diagrams.
-

Technical reference manuals

The technical reference manuals describe reference information for robotics products, for example lubrication, the RAPID language, and system parameters.

Application manuals

Specific applications (for example software or hardware options) are described in **Application manuals**. An application manual can describe one or several applications.

An application manual generally contains information about:

- The purpose of the application (what it does and when it is useful).
- What is included (for example cables, I/O boards, RAPID instructions, system parameters, software).
- How to install included or required hardware.
- How to use the application.
- Examples of how to use the application.

Continues on next page

Operating manuals

The operating manuals describe hands-on handling of the products. The manuals are aimed at those having first-hand operational contact with the product, that is production cell operators, programmers, and troubleshooters.

How to read the product manual

Reading the procedures

The procedures contain all information required for the installation or service activity and can be printed out separately when needed for a certain service procedure.

Safety information

The manual includes a separate safety chapter that must be read through before proceeding with any service or installation procedures. All procedures also include specific safety information when dangerous steps are to be performed.

Read more in the chapter [Safety on page 15](#).

Illustrations

The product is illustrated with general figures that does not take painting or protection type in consideration.

Likewise, certain work methods or general information that is valid for several product models, can be illustrated with illustrations that show a different product model than the one that is described in the current manual.

This page is intentionally left blank

1 Safety

1.1 Safety information

1.1.1 Limitation of liability

Limitation of liability

Any information given in this manual regarding safety must not be construed as a warranty by ABB that the industrial robot will not cause injury or damage even if all safety instructions are complied with.

The information does not cover how to design, install and operate a robot system, nor does it cover all peripheral equipment that can influence the safety of the robot system.

In particular, liability cannot be accepted if injury or damage has been caused for any of the following reasons:

- Use of the robot in other ways than intended.
- Incorrect operation or maintenance.
- Operation of the robot when the safety devices are defective, not in their intended location or in any other way not working.
- When instructions for operation and maintenance are not followed.
- Non-authorized design modifications of the robot.
- Repairs on the robot and its spare parts carried out by in-experienced or non-qualified personnel.
- Foreign objects.
- Force majeure.

Spare parts and equipment

ABB supplies original spare parts and equipment which have been tested and approved. The installation and/or use of non-original spare parts and equipment can negatively affect the safety, function, performance, and structural properties of the robot. ABB is not liable for damages caused by the use of non-original spare parts and equipment.

1 Safety

1.1.2 Requirements on personnel

1.1.2 Requirements on personnel

General

Only personnel with appropriate training are allowed to install, maintain, service, repair, and use the robot. This includes electrical, mechanical, hydraulics, pneumatics, and other hazards identified in the risk assessment.

Persons who are under the influence of alcohol, drugs or any other intoxicating substances are not allowed to install, maintain, service, repair, or use the robot.

The plant liable must make sure that the personnel is trained on the robot, and on responding to emergency or abnormal situations.

Personal protective equipment

Use personal protective equipment, as stated in the instructions.

1.2 Safety signals and symbols

1.2.1 Safety signals in the manual







Introduction to safety signals

This section specifies all safety signals used in the user manuals. Each signal consists of:

- A caption specifying the hazard level (DANGER, WARNING, or CAUTION) and the type of hazard.
- Instruction about how to reduce the hazard to an acceptable level.
- A brief description of remaining hazards, if not adequately reduced.

Hazard levels

The table below defines the captions specifying the hazard levels used throughout this manual.

Symbol	Designation	Significance
	DANGER	Signal word used to indicate an imminently hazardous situation which, if not avoided, will result in serious injury.
	WARNING	Signal word used to indicate a potentially hazardous situation which, if not avoided, could result in serious injury.
	ELECTRICAL SHOCK	Signal word used to indicate a potentially hazardous situation related to electrical hazards which, if not avoided, could result in serious injury.
	CAUTION	Signal word used to indicate a potentially hazardous situation which, if not avoided, could result in slight injury.
	ELECTROSTATIC DISCHARGE (ESD)	Signal word used to indicate a potentially hazardous situation which, if not avoided, could result in severe damage to the product.
	NOTE	Signal word used to indicate important facts and conditions.

Continues on next page

1 Safety

1.2.1 Safety signals in the manual

Continued

Symbol	Designation	Significance
	TIP	Signal word used to indicate where to find additional information or how to do an operation in an easier way.

1.2.2 Safety symbols on manipulator labels

Introduction to symbols

This section describes safety symbols used on labels (stickers) on the manipulator. Symbols are used in combinations on the labels, describing each specific warning. The descriptions in this section are generic, the labels can contain additional information such as values.



Note

The symbols on the labels on the product must be observed. Additional symbols added by the integrator must also be observed.



Types of symbols

Both the manipulator and the controller are marked with symbols, containing important information about the product. This is important for all personnel handling the robot, for example during installation, service, or operation.

The safety labels are language independent, they only use graphics. See [Symbols on safety labels on page 19](#).

The information labels can contain information in text.

Symbols on safety labels



Symbol	Description
 xx0900000812	Warning! Warns that an accident <i>may</i> occur if the instructions are not followed that can lead to serious injury, possibly fatal, and/or great damage to the product. It applies to warnings that apply to danger with, for example, contact with high voltage electrical units, explosion or fire risk, risk of poisonous gases, risk of crushing, impact, fall from height, etc.
 xx0900000811	Caution! Warns that an accident may occur if the instructions are not followed that can result in injury and/or damage to the product. It also applies to warnings of risks that include burns, eye injury, skin injury, hearing damage, crushing or slipping, tripping, impact, fall from height, etc. Furthermore, it applies to warnings that include function requirements when fitting and removing equipment where there is a risk of damaging the product or causing a breakdown.
 xx0900000839	Prohibition Used in combinations with other symbols.

Continues on next page

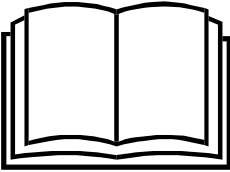
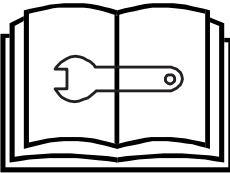
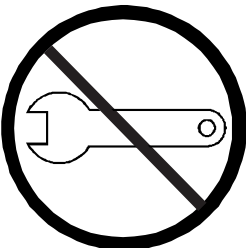
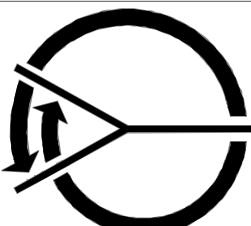

1 Safety

1.2.2 Safety symbols on manipulator labels

Continued

Symbol	Description
 xx0900000813	See user documentation Read user documentation for details. Which manual to read is defined by the symbol: <ul style="list-style-type: none">• No text: <i>Product manual</i>.
 xx0900000816	Before disassembly, see product manual
 xx0900000815	Do not disassemble Disassembling this part can cause injury.
 xx0900000814	Extended rotation This axis has extended rotation (working area) compared to standard.
 xx0900000808	Brake release Pressing this button will release the brakes. This means that the robot arm can fall down.

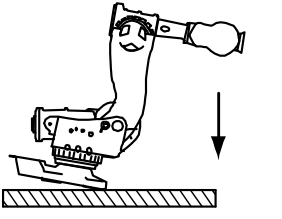

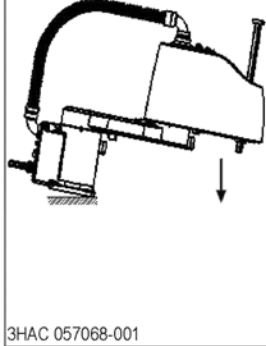
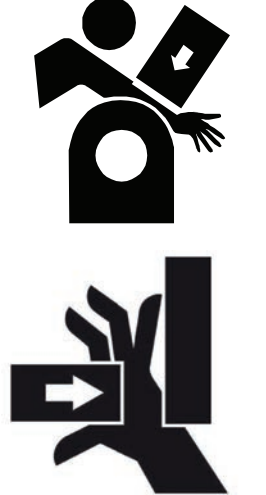
Continues on next page

Symbol	Description
 <p>xx0900000810</p>   <p>3HAC 057068-001</p> <p>xx1500002402</p>	<p>Tip risk when loosening bolts The robot can tip over if the bolts are not securely fastened.</p>
 <p>xx0900000817</p>	<p>Crush Risk of crush injuries.</p>





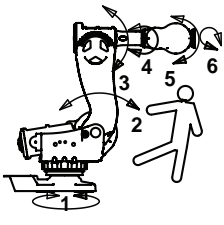
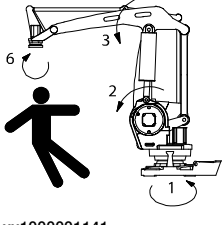
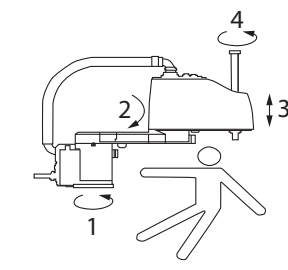

1 Safety

1.2.2 Safety symbols on manipulator labels

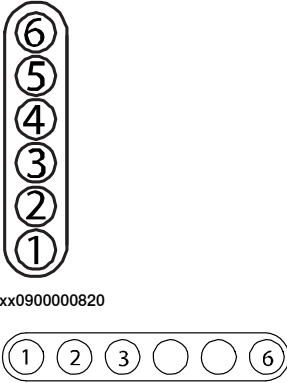
Continued

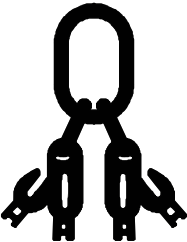
Symbol	Description
 xx0900000818  xx1300001087	Heat Risk of heat that can cause burns. (Both signs are used)
 xx0900000819  xx1000001141  xx1500002616	Moving robot The robot can move unexpectedly.

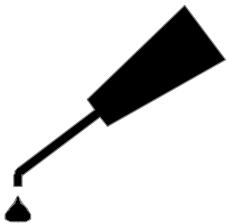
Continues on next page





Symbol	Description
 <p>xx0900000820</p> <p>xx1000001140</p>	<p>Brake release buttons</p>
 <p>xx0900000821</p>	<p>Lifting bolt</p>
 <p>xx1000001242</p>	<p>Chain sling with shortener</p>
 <p>xx0900000822</p>	<p>Lifting of robot</p>
 <p>xx0900000823</p>	<p>Oil Can be used in combination with prohibition if oil is not allowed.</p>
 <p>xx0900000824</p>	<p>Mechanical stop</p>

Continues on next page

1 Safety

1.2.2 Safety symbols on manipulator labels

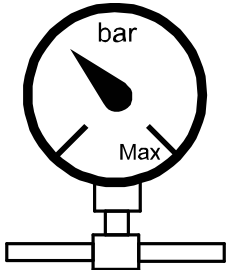
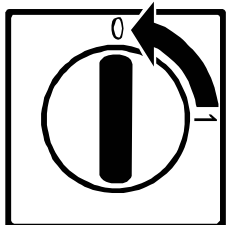
Continued

Symbol	Description
 xx1000001144	No mechanical stop
 xx0900000825	Stored energy Warns that this part contains stored energy. Used in combination with <i>Do not disassemble</i> symbol.
 xx0900000826	Pressure Warns that this part is pressurized. Usually contains additional text with the pressure level.
 xx0900000827	Shut off with handle Use the power switch on the controller.
 xx1400002648	Do not step Warns that stepping on these parts can cause damage to the parts.

1.3 Robot stopping functions

Protective stop and emergency stop

The protective stops and emergency stops are described in the product manual for the controller.

For more information see:

- *Product manual - OmniCore C30*
- *Product manual - OmniCore C90XT*
- *Product manual - OmniCore E10*

1 Safety

1.4 Safety during installation and commissioning

1.4 Safety during installation and commissioning

National or regional regulations

The integrator of the robot system is responsible for the safety of the robot system.

The integrator is responsible that the robot system is designed and installed in accordance with the safety requirements set forth in the applicable national and regional standards and regulations.

The integrator of the robot system is required to perform a risk assessment.

Layout

The robot integrated to a robot system shall be designed to allow safe access to all spaces during installation, operation, maintenance, and repair.

If robot movement can be initiated from an external control panel then an emergency stop must also be available.

If the manipulator is delivered with mechanical stops, these can be used for reducing the working space.

A perimeter safeguarding, for example a fence, shall be dimensioned to withstand the following:

- The force of the manipulator.
- The force of the load handled by the robot if dropped or released at maximum speed.
- The maximum possible impact caused by a breaking or malfunctioning rotating tool or other device fitted to the robot.

The maximum TCP speed and the maximum velocity of the robot axes are detailed in the section *Robot motion* in the product specification for the respective manipulator.

Consider exposure to hazards, such as slipping, tripping, and falling.

Hazards due to the working position and posture for a person working with or near the robot shall be considered.

Hazards due to noise emission from the robot needs to be considered.

Consider hazards from other equipment in the robot system, for example, that guards remain active until identified hazards are reduced to an acceptable level.

Allergenic material

See [Environmental information on page 986](#) for specification of allergenic materials in the product, if any.

Securing the robot to the foundation

The robot must be properly fixed to its foundation/support, as described in the respective product manual.

When the robot is installed at a height, hanging, or other than mounted directly on the floor, there will be additional hazards.

Continues on next page

Electrical safety

Incoming mains must be installed to fulfill national regulations.

The power supply wiring to the robot must be sufficiently fused and if necessary, it must be possible to disconnect it manually from the mains power.

The power to the robot must be turned off with the main switch and the mains power disconnected when performing work inside the controller cabinet. Lock and tag shall be considered.

Harnesses between controller and manipulator shall be fixed and protected to avoid tripping and wear.

Wherever possible, power on/off or rebooting the robot controller shall be performed with all persons outside the safeguarded space.



Note

Use a CARBON DIOXIDE (CO₂) extinguisher in the event of a fire in the robot.

Safety devices

The integrator is responsible for that the safety devices necessary to protect people working with the robot system are designed and installed correctly.

When integrating the robot with external devices to a robot system:

- The integrator of the robot system must ensure that emergency stop functions are interlocked in accordance with applicable standards.
- The integrator of the robot system must ensure that safety functions are interlocked in accordance with applicable standards.

Other hazards

A robot may perform unexpected limited movement.



WARNING

Manipulator movements can cause serious injuries on users and may damage equipment.

The risk assessment should also consider other hazards arising from the application, such as, but not limited to:

- Water
- Compressed air
- Hydraulics

End-effector hazards require particular attention for applications which involve close human collaboration with the robot.

Continues on next page

1 Safety

1.4 Safety during installation and commissioning

Continued

Pneumatic or hydraulic related hazards



Note

The pressure in the complete pneumatic or hydraulic systems must be released before service and maintenance.

All components in the robot system that remain pressurized after switching off the power to the robot must be marked with clearly visible drain facilities and a warning sign that indicates the hazard of stored energy.

Loss of pressure in the robot system may cause parts or objects to drop.

Dump valves should be used in case of emergency.

Shot bolts should be used to prevent tools, etc., from falling due to gravity.

All pipes, hoses, and connections have to be inspected regularly for leaks and damage. Damage must be repaired immediately.

Verify the safety functions

Before the robot system is put into operation, verify that the safety functions are working as intended and that any remaining hazards identified in the risk assessment are mitigated to an acceptable level.

1.5 Safety during operation

Automatic operation

Verify the application in the operating mode manual reduced speed, before changing mode to automatic and initiating automatic operation.

Unexpected movement of robot arm



WARNING

Hazards due to the use of brake release devices and/or gravity beneath the manipulator shall be considered.

A robot may perform unexpected limited movement.



WARNING

Manipulator movements can cause serious injuries on users and may damage equipment.

1 Safety

1.6.1 Safety during maintenance and repair

1.6 Safety during maintenance and repair

1.6.1 Safety during maintenance and repair

General

Corrective maintenance must only be carried out by personnel trained on the robot. Maintenance or repair must be done with all electrical, pneumatic, and hydraulic power switched off, that is, no remaining hazards.

Hazards due to stored mechanical energy in the manipulator for the purpose of counterbalancing axes must be considered before maintenance or repair.

Never use the robot as a ladder, which means, do not climb on the controller, manipulator, including motors, or other parts. There are hazards of slipping and falling. The robot might be damaged.

Make sure that there are no loose screws, turnings, or other unexpected parts remaining after work on the robot has been performed.

When the work is completed, verify that the safety functions are working as intended.

Hot surfaces

Surfaces can be hot after running the robot, and touching these may result in burns. Allow the surfaces to cool down before maintenance or repair.

Allergic reaction

Warning	Description	Elimination/Action
 Allergic reaction	When working with lubricants there is a risk of an allergic reaction.	Make sure that protective gear like goggles and gloves are always worn.

Gearbox lubricants (oil or grease)

When handling oil, grease, or other chemical substances the safety information of the respective manufacturer must be observed.







Note

Take special care when handling hot lubricants.

Warning	Description	Elimination/Action
 Hot oil or grease	Changing and draining gearbox oil or grease may require handling hot lubricant heated up to 90 °C.	Make sure that protective gear like goggles and gloves are always worn during this activity.

Continues on next page

Warning	Description	Elimination/Action
 Allergic reaction	When working with lubricants there is a risk of an allergic reaction.	Make sure that protective gear like goggles and gloves are always worn.
 Possible pressure build-up in gearbox	When opening the oil or grease plug, there may be pressure present in the gearbox, causing lubricant to spray from the opening.	Open the plug carefully and keep away from the opening. Do not overfill the gearbox when filling.
 Do not overfill	Overfilling of gearbox lubricant can lead to internal over-pressure inside the gearbox which in turn may: <ul style="list-style-type: none"> • damage seals and gaskets • completely press out seals and gaskets • prevent the robot from moving freely. 	Make sure not to overfill the gearbox when filling it with oil or grease. After filling, verify that the level is correct.
 Specified amount depends on drained volume	The specified amount of oil or grease is based on the total volume of the gearbox. When changing the lubricant, the amount refilled may differ from the specified amount, depending on how much has previously been drained from the gearbox.	After filling, verify that the level is correct.
 Contaminated oil in gearboxes	For lifetime reasons always drain as much oil as possible from the gearbox. The magnetic oil plugs will gather residual metal chips.	

Hazards related to batteries

Under rated conditions, the electrode materials and liquid electrolyte in the batteries are sealed and not exposed to the outside.

There is a hazard in case of abuse (mechanical, thermal, electrical) which leads to the activation of safety valves and/or the rupture of the battery container. As a result under certain circumstances, electrolyte leakage, electrode materials reaction with moisture/water or battery vent/explosion/fire may follow.

Do not short circuit, recharge, puncture, incinerate, crush, immerse, force discharge or expose to temperatures above the declared operating temperature range of the product. Risk of fire or explosion.

Operating temperatures are listed in [Operating conditions, robot on page 40](#).

See safety instructions for the batteries in *Material/product safety data sheet - Battery pack (3HAC043118-001)*.

Continues on next page

1 Safety

1.6.1 Safety during maintenance and repair

Continued

Unexpected movement of robot arm



WARNING

Hazards due to the use of brake release devices and/or gravity beneath the manipulator shall be considered.

A robot may perform unexpected limited movement.



WARNING

Manipulator movements can cause serious injuries on users and may damage equipment.

Related information

See also the safety information related to installation and operation.

1.6.2 Emergency release of the robot axes

Description

In an emergency situation, the brakes on a robot axis can be released manually by pushing a brake release button.

How to release the brakes is described in the section:

- [Manually releasing the brakes on page 63.](#)

The robot may be moved manually on smaller robot models, but larger models may require using an overhead crane or similar equipment.

Increased injury

Before releasing the brakes, make sure that the weight of the manipulator does not result in additional hazards, for example, even more severe injuries on a trapped person.



DANGER

When releasing the holding brakes, the robot axes may move very quickly and sometimes in unexpected ways.

Make sure no personnel is near or beneath the robot.

1 Safety

1.6.3 Brake testing

1.6.3 Brake testing

When to test

During operation, the holding brake of each axis normally wears down. A test can be performed to determine whether the brake can still perform its function.

How to test

The function of the holding brake of each axis motor may be verified as described below:

- 1 Run each axis to a position where the combined weight of the manipulator and any load is maximized (maximum static load).
- 2 Switch the motor to the MOTORS OFF.
- 3 Inspect and verify that the axis maintains its position.

If the manipulator does not change position as the motors are switched off, then the brake function is adequate.



Note

It is recommended to run the service routine *BrakeCheck* as part of the regular maintenance, see the operating manual for the robot controller.

For robots with the option SafeMove, the *Cyclic Brake Check* routine is recommended. See the manual for SafeMove in [References on page 10](#).

1.7 Safety during troubleshooting

General

When troubleshooting requires work with power switched on, special considerations must be taken:

- Safety circuits might be muted or disconnected.
- Electrical parts must be considered as *live*.
- The manipulator can move unexpectedly at any time.



DANGER

Troubleshooting on the controller while powered on must be performed by personnel trained by ABB or by ABB field engineers.

A risk assessment must be done to address both robot and robot system specific hazards.



WARNING

Hazards due to the use of brake release devices and/or gravity beneath the manipulator shall be considered.

A robot may perform unexpected limited movement.



WARNING

Manipulator movements can cause serious injuries on users and may damage equipment.

Related information

See also the safety information related to installation, operation, maintenance, and repair.

1 Safety

1.8 Safety during decommissioning

1.8 Safety during decommissioning

General

See section [Decommissioning on page 985](#).

If the robot is decommissioned for storage, take extra precaution to reset safety devices to delivery status.

Unexpected movement of robot arm



WARNING

Hazards due to the use of brake release devices and/or gravity beneath the manipulator shall be considered.

A robot may perform unexpected limited movement.



WARNING

Manipulator movements can cause serious injuries on users and may damage equipment.

2 Manipulator description

2.1 About IRB 920

Introduction

The IRB 920 is one of ABB Robotics latest generation of 4-axis robot, with a payload of 6 kg, designed based on industrial robot platform. The robot has an open structure that is especially adapted for flexible use, and can communicate extensively with external systems.

The IRB 920 contains the following variants:

- IRB 920T-6/0.45
- IRB 920T-6/0.55
- IRB 920T-6/0.65



Note

Without any specific statement, IRB 920 represents all variants under this product.

2 Manipulator description

2.2 Technical data

2.2 Technical data

Weight, robot

The table shows the weight of the robot.

Robot model	Nominal weight
IRB 920	IRB 920T-6/0.45: 22 kg
	IRB 920T-6/0.55: 23 kg
	IRB 920T-6/0.65: 24 kg



Note

The weight does not include additional options, tools and other equipment fitted on the robot.

Loads on foundation, robot

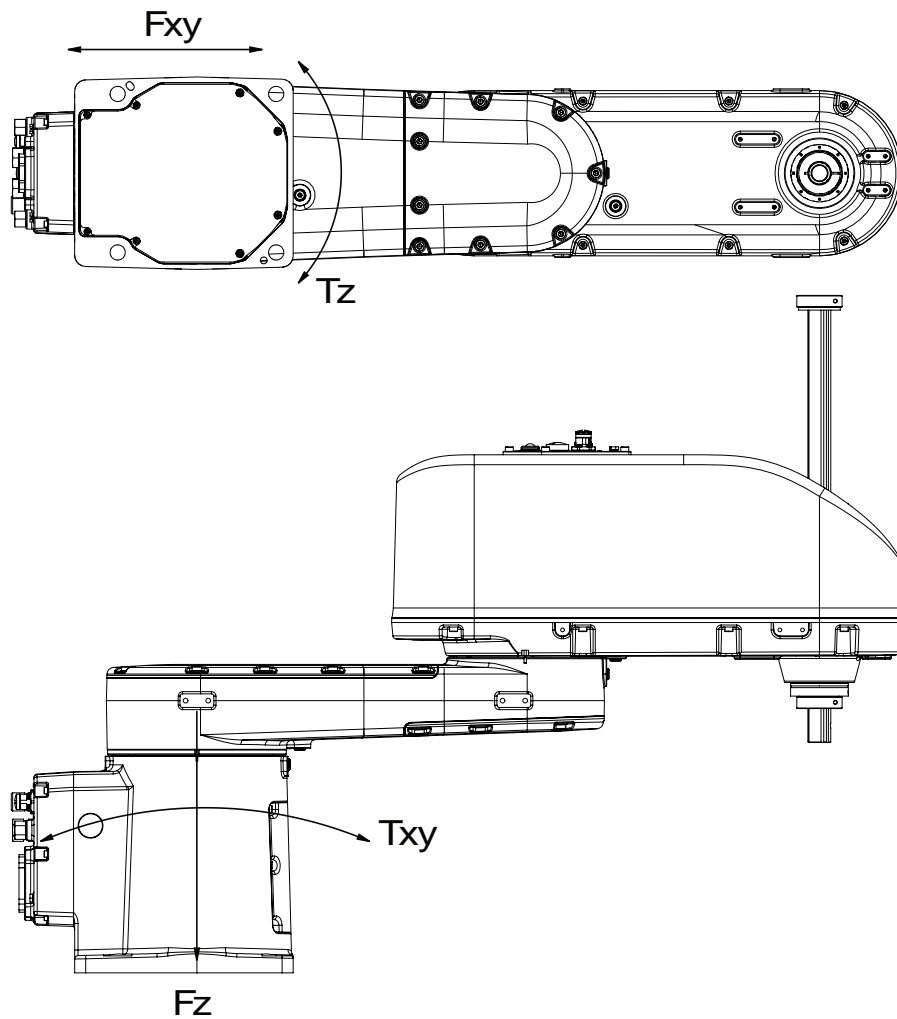

xx2000001168

F_{xy}	Force in any direction in Plane XY
F_z	Force along Axis Z

Continues on next page

T_{xy}	Bending moment in any direction in Plane XY
T_z	Torsional moment around Axis Z

The table shows the various forces and torques working on the robot during different kinds of operation.



Note

These forces and torques are extreme values that are rarely encountered during operation. The values also never reach their maximum at the same time!



WARNING

The robot installation is restricted to the mounting options given in following load table(s).

Floor mounted

Force	Endurance load (in operation)	Maximum load (emergency stop)
Force xy	±550 N	±1500 N
Force z	±550 N	±650 N
Torque xy	±330 Nm	±500 Nm
Torque z	±150 Nm	±900 Nm

Requirements, foundation

The table shows the requirements for the foundation where the weight of the installed robot is included:

Requirement	Value	Note
Flatness of foundation surface	0.1/500 mm	Flat foundations give better repeatability of the resolver calibration compared to original settings on delivery from ABB. The value for levelness aims at the circumstance of the anchoring points in the robot base. In order to compensate for an uneven surface, the robot can be recalibrated during installation. If resolver/encoder calibration is changed this will influence the absolute accuracy.
Maximum tilt	0°	
Minimum resonance frequency	22 Hz Note It may affect the manipulator life-time to have a lower resonance frequency than recommended.	The value is recommended for optimal performance. Due to foundation stiffness, consider robot mass including equipment. ⁱ For information about compensating for foundation flexibility, see <i>Application manual - Controller software OmniCore</i> , section <i>Motion Process Mode</i> .

Continues on next page

2 Manipulator description

2.2 Technical data

Continued

Requirement	Value	Note
Minimum foundation material yield strength	150 MPa	

- ⁱ The minimum resonance frequency given should be interpreted as the frequency of the robot mass/inertia, robot assumed stiff, when a foundation translational/torsional elasticity is added, i.e., the stiffness of the pedestal where the robot is mounted. The minimum resonance frequency should not be interpreted as the resonance frequency of the building, floor etc. For example, if the equivalent mass of the floor is very high, it will not affect robot movement, even if the frequency is well below the stated frequency. The robot should be mounted as rigid as possible to the floor.
- Disturbances from other machinery will affect the robot and the tool accuracy. The robot has resonance frequencies in the region 10 – 20 Hz and disturbances in this region will be amplified, although somewhat damped by the servo control. This might be a problem, depending on the requirements from the applications. If this is a problem, the robot needs to be isolated from the environment.

Storage conditions, robot

The table shows the allowed storage conditions for the robot:

Parameter	Value
Minimum ambient temperature	-25 °C
Maximum ambient temperature	55 °C
Maximum ambient temperature (less than 24 hrs)	70 °C
Maximum ambient humidity	95% at constant temperature (gaseous only)

Operating conditions, robot

The table shows the allowed operating conditions for the robot:

Parameter	Value
Minimum ambient temperature	+5°C ⁱ
Maximum ambient temperature	+45°C
Maximum ambient humidity	5% - 95% non-condensing according to IEC61131-2

- ⁱ At low environmental temperature < 10°C is, as with any other machine, a warm-up phase recommended to be run with the robot. Otherwise there is a risk that the robot stops or run with lower performance due to temperature dependent oil and grease viscosity.

Protection classes, robot

The table shows the available protection types of the robot, with the corresponding protection class.

Protection type	Protection class ⁱ
Manipulator, protection type Standard	IP30 ⁱⁱ IP54 (option 3350-540)
Manipulator, protection type Clean Room	ISO Class 5

- ⁱ According to IEC 60529.

- ⁱⁱ The protection class of the ballscrew area is IP20. For more information, please contact ABB.

Environmental information

The product complies with IEC 63000. *Technical documentation for the assessment of electrical and electronic products with respect to the restriction of hazardous substances.*

2.3 Robot dimensions

Dimensions for rear outlet cable version

Robots with protection class IP30 3350-300

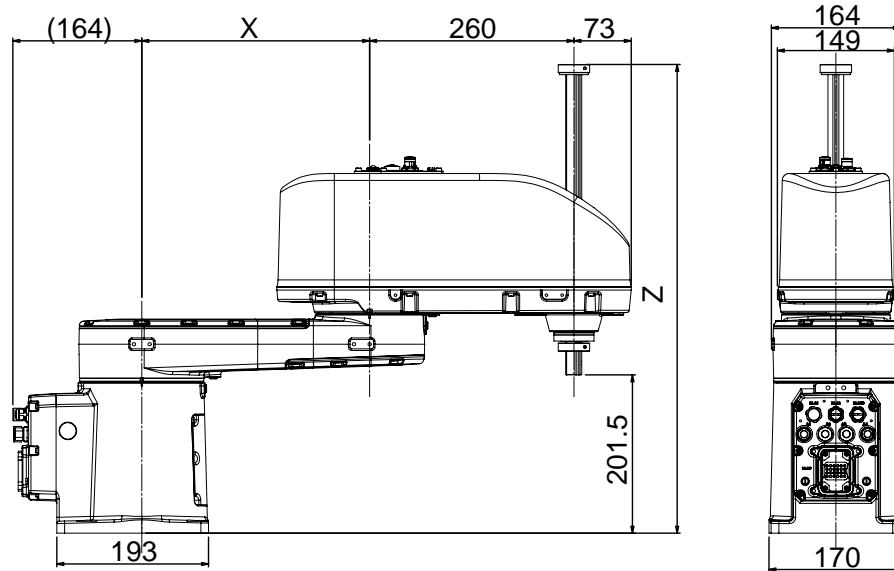

xx2000001145

	0.45_0.18	0.45_0.3	0.55_0.18	0.55_0.3	0.65_0.18	0.65_0.3
X	190 mm	190 mm	290 mm	290 mm	390 mm	390 mm
Z	596.5 mm	716.5 mm	596.5 mm	716.5 mm	596.5 mm	716.5 mm

Robots with protection class IP54 (option 3350-540) or with protection type Clean Room (option 3351-5)

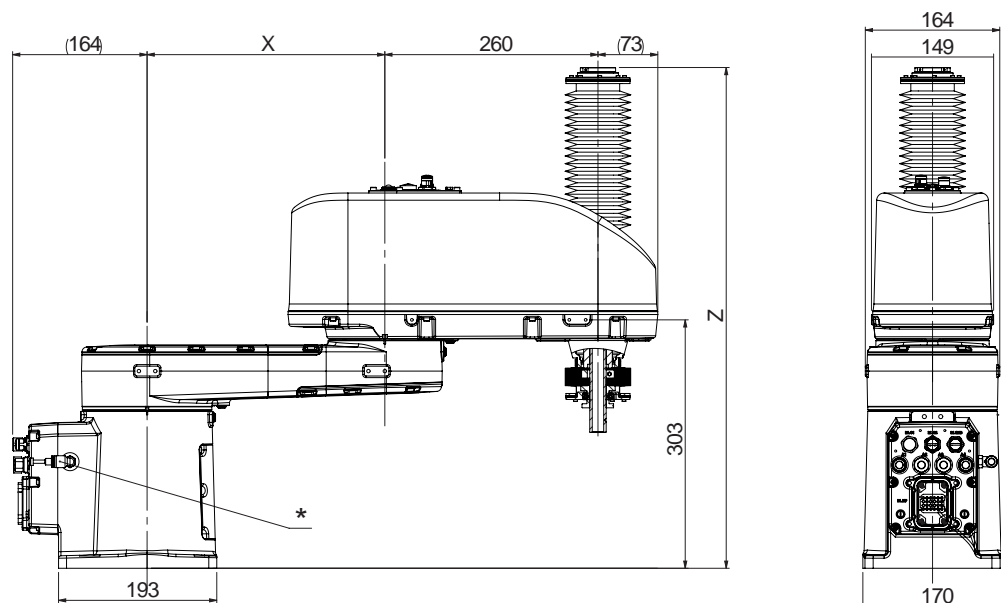

xx2100002391

*: For Clean Room only.

Continues on next page

2 Manipulator description

2.3 Robot dimensions

Continued

	0.45_0.18	0.45_0.3	0.55_0.18	0.55_0.3	0.65_0.18	0.65_0.3
X	190 mm	190 mm	290 mm	290 mm	390 mm	390 mm
Z	610.8 mm	728.7 mm	610.8 mm	728.7 mm	610.8 mm	728.7 mm
W	165.7 mm	150.7 mm	165.7 mm	150.7 mm	165.7 mm	150.7 mm

Dimensions for underneath outlet cable version

Robots with protection class IP30 3350-300

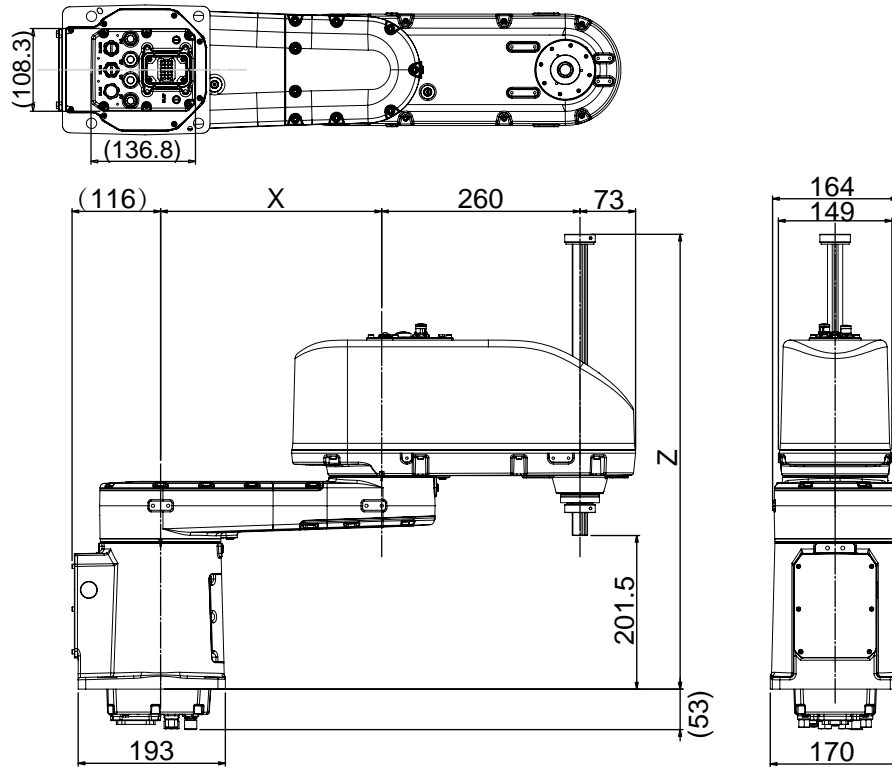

xx2000001146

	0.45_0.18	0.45_0.3	0.55_0.18	0.55_0.3	0.65_0.18	0.65_0.3
X	190 mm	190 mm	290 mm	290 mm	390 mm	390 mm
Z	596.5 mm	716.5 mm	596.5 mm	716.5 mm	596.5 mm	716.5 mm

Continues on next page

2 Manipulator description

2.3 Robot dimensions

Continued

Robots with protection class IP54 (option 3350-540) or with protection type Clean Room (option 3351-5)

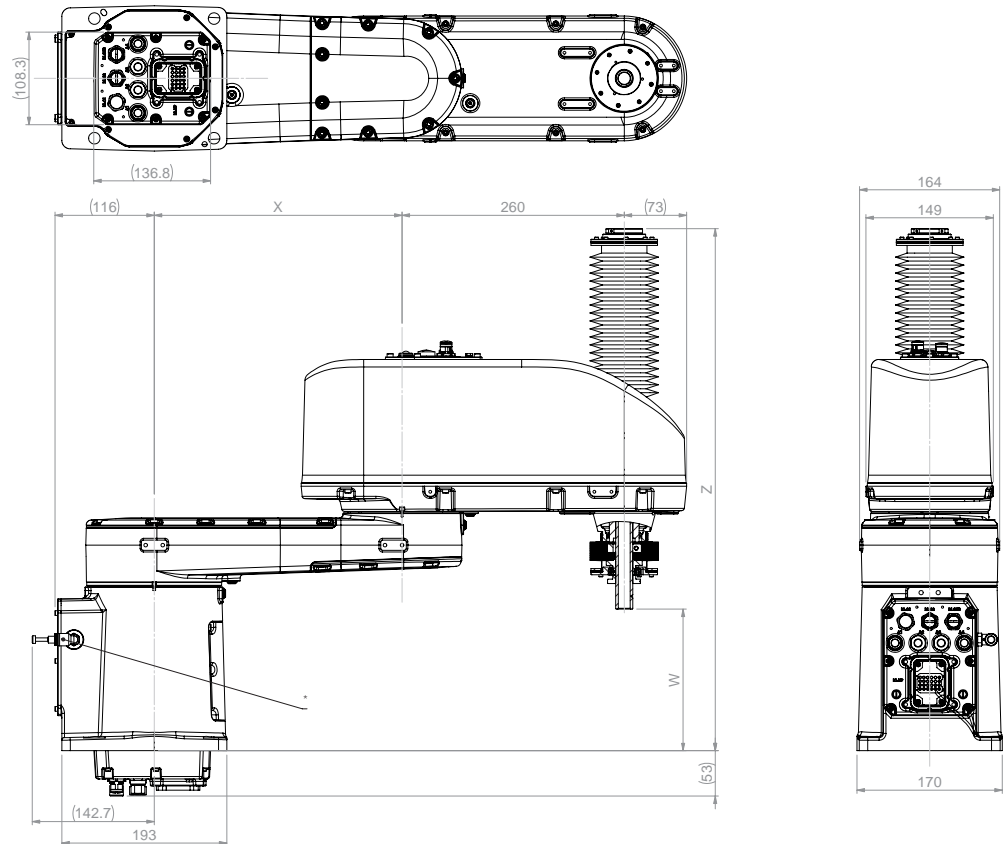

xx2100002429

*: For Clean Room only.

	0.45_0.18	0.45_0.3	0.55_0.18	0.55_0.3	0.65_0.18	0.65_0.3
X	190 mm	190 mm	290 mm	290 mm	390 mm	390 mm
Z	610.8 mm	728.7 mm	610.8 mm	728.7 mm	610.8 mm	728.7 mm
W	165.7 mm	150.7 mm	165.7 mm	150.7 mm	165.7 mm	150.7 mm

2 Manipulator description

2.4 Working range

2.4 Working range

Illustration, working range

Robots with protection class IP30 3350-300

This illustration shows the unrestricted working range of the robot.

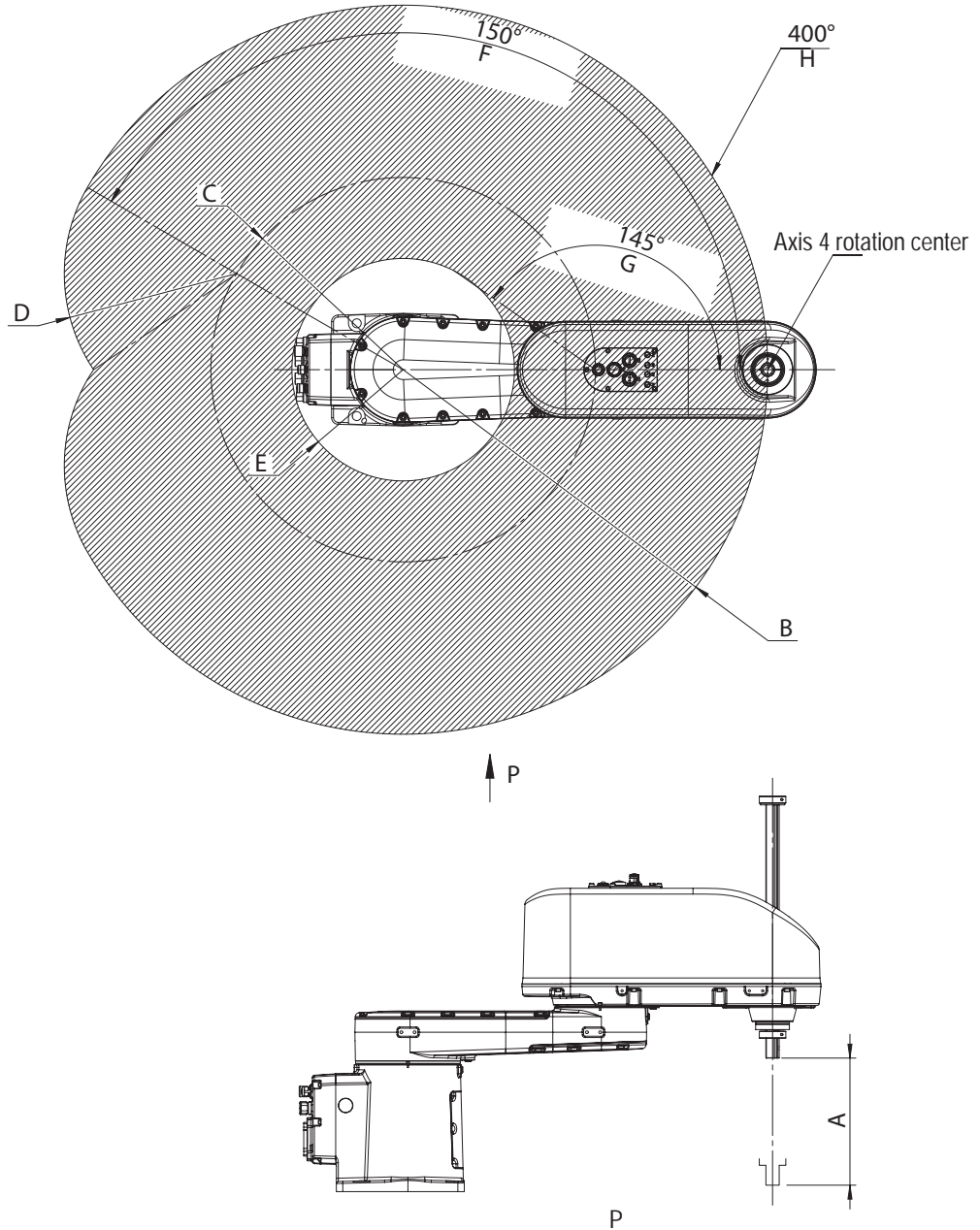

xx2000001137

	0.45_0.18	0.45_0.3	0.55_0.18	0.55_0.3	0.65_0.18	0.65_0.3
A (Axis3)	180 mm	300 mm	180 mm	300 mm	180 mm	300 mm
B	450 mm		550 mm		650 mm	

Continues on next page

2 Manipulator description

2.4 Working range

Continued

	0.45_0.18	0.45_0.3	0.55_0.18	0.55_0.3	0.65_0.18	0.65_0.3
C	190 mm		290 mm		390 mm	
D	260 mm					
E	150.9 mm		167.8 mm		231.5 mm	
F (Axis1)	±150°					
G (Axis2)	±145°					
H (Axis4)	±400°					

Continues on next page

2 Manipulator description

2.4 Working range

Continued

Robots with protection class IP54 (option 3350-540) or with protection type Clean Room (option 3351-5)

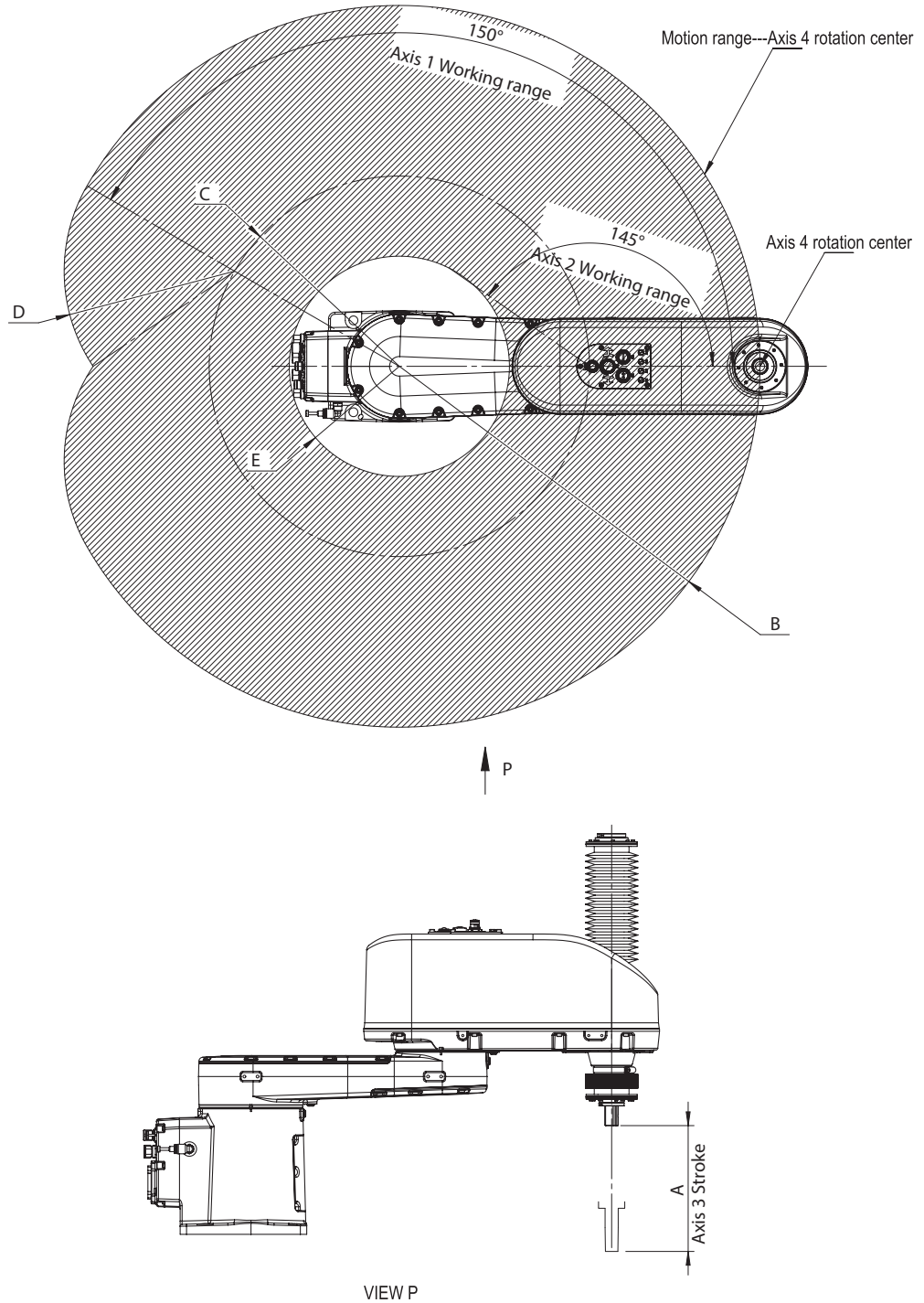

xx2100002430

	0.45_0.18	0.45_0.3	0.55_0.18	0.55_0.3	0.65_0.18	0.65_0.3
A (Axis3)	145 mm	250 mm	145 mm	250 mm	145 mm	250 mm
B	450 mm		550 mm		650 mm	
C	190 mm		290 mm		390 mm	

Continues on next page

2 Manipulator description

2.4 Working range

Continued

	0.45_0.18	0.45_0.3	0.55_0.18	0.55_0.3	0.65_0.18	0.65_0.3
D	260 mm					
E	150.9 mm		167.8 mm		231.5 mm	
F (Axis1)	±150°					
G (Axis2)	±145°					
H (Axis4)	±400°					

Working range

Axis	Working range	Note
Axis 1	±150°	
Axis 2	±145°	
Axis 3	Robots with protection class IP30 (option 3350-300) 180 mm/300 mm	Value for restricted working range.
	Robots with protection class IP54 (option 3350-540) or with protection type Clean Room (option 3351-5) 145 mm/250 mm	Value for restricted working range.
Axis 4	±400°	Default value.

2 Manipulator description

2.5 Information labels

2.5 Information labels

Illustration

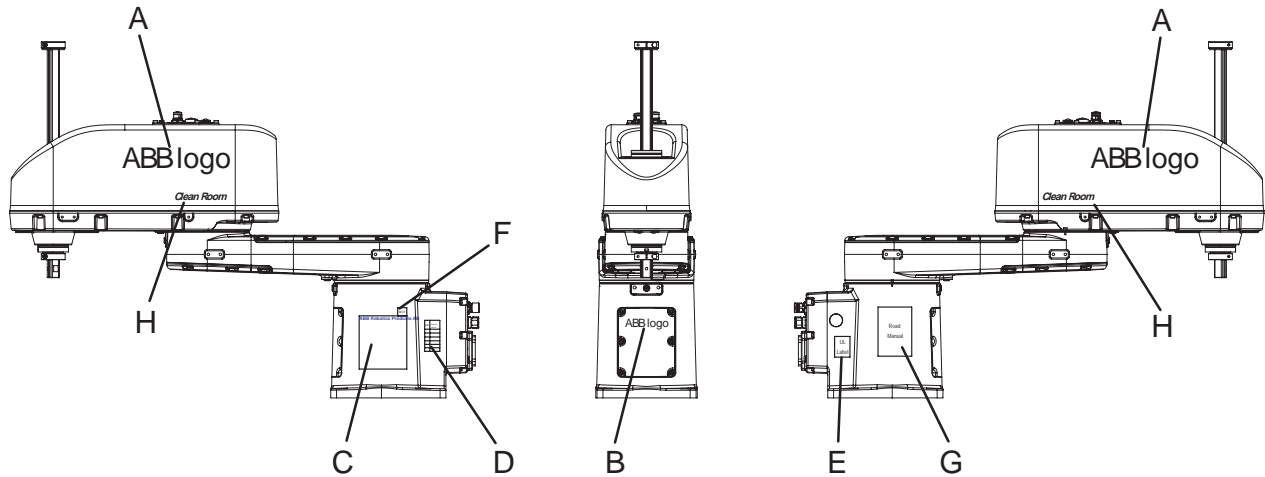

xx2000001143

A	ABB logo (Big size)
B	ABB logo (Small size)
C	Rating label
D	Calibration label
E	UL label
F	WEEE label
G	Read manual and caution
H	Clean Room label ⁱ

ⁱ Only for robots with protection type Clean Room.

2.6 The unit is sensitive to ESD

Description

ESD (electrostatic discharge) is the transfer of electrical static charge between two bodies at different potentials, either through direct contact or through an induced electrical field. When handling parts or their containers, personnel not grounded may potentially transfer high static charges. This discharge may destroy sensitive electronics.

Safe handling

Use one of the following alternatives:

- Use a wrist strap.

Wrist straps must be tested frequently to ensure that they are not damaged and are operating correctly.

- Use an ESD protective floor mat.

The mat must be grounded through a current-limiting resistor.

- Use a dissipative table mat.

The mat should provide a controlled discharge of static voltages and must be grounded.

This page is intentionally left blank

3 Installation and commissioning

3.1 Introduction to installation and commissioning

General

This chapter contains assembly instructions and information for installing the IRB 920 at the working site.

See also the product manual for the robot controller.

The installation must be done by qualified installation personnel in accordance with the safety requirements set forth in the applicable national and regional standards and regulations.

Safety information

Before any installation work is commenced, all safety information must be observed. There are general safety aspects that must be read through, as well as more specific safety information that describes the danger and safety risks when performing the procedures. Read the chapter [Safety on page 15](#) before performing any installation work.



Note

Always connect the IRB 920 and the robot to protective earth and residual current device (RCD) before connecting to power and starting any installation work.

For more information see:

- *Product manual - OmniCore C30*
- *Product manual - OmniCore C90XT*
- *Product manual - OmniCore E10*

3 Installation and commissioning

3.2.1 Pre-installation procedure

3.2 Unpacking

3.2.1 Pre-installation procedure

Introduction

This section is intended for use when unpacking and installing the robot for the first time. It also contains information useful during later re-installation of the robot.

Prerequisites for installation personnel

Installation personnel working with an ABB product must:

- Be trained by ABB and have the required knowledge of mechanical and electrical installation/maintenance/repair work.
- Conform to all national and local codes.

Checking the pre-requisites for installation

	Action
1	Make a visual inspection of the packaging and make sure that nothing is damaged.
2	Remove the packaging.
3	Check for any visible transport damage.  Note Stop unpacking and contact ABB if transport damages are found.
4	Clean the unit with a lint-free cloth, if necessary.
5	Make sure that the lifting accessory used (if required) is suitable to handle the weight of the robot as specified in: Weight, robot on page 38
6	If the robot is not installed directly, it must be stored as described in: Storage conditions, robot on page 40
7	Make sure that the expected operating environment of the robot conforms to the specifications as described in: Operating conditions, robot on page 40
8	Before taking the robot to its installation site, make sure that the site conforms to: <ul style="list-style-type: none">• Loads on foundation, robot on page 38• Protection classes, robot on page 40• Requirements, foundation on page 39
9	Before moving the robot, please observe the stability of the robot: Risk of tipping/stability on page 53
10	When these prerequisites are met, the robot can be taken to its installation site as described in section: On-site installation on page 55
11	Install required equipment, if any.

3.2.2 Risk of tipping/stability

Risk of tipping

If the robot is not fastened to the foundation while moving the arm, the robot is not stable in the whole working area. Moving the arm will displace the center of gravity, which may cause the robot to tip over.

The shipping position is the most stable position.

Do not change the robot position before securing it to the foundation!

Shipping and transportation position

This figure shows the robot in its shipping position and transportation position.

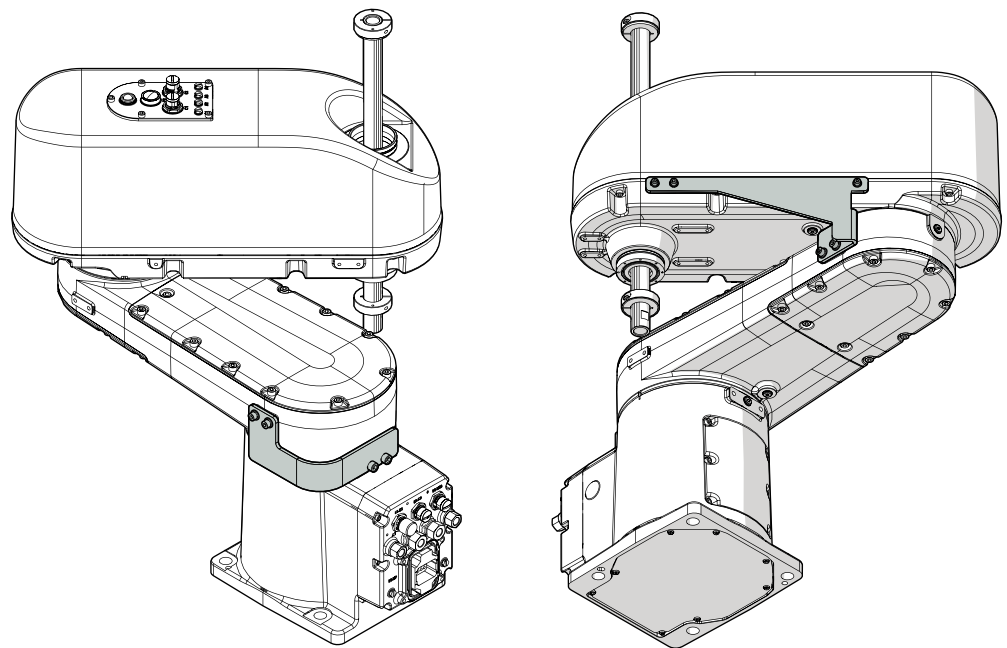

xx2000001152

Transportation bracket

At delivery, the robot is locked in the correct position with a transportation bracket for securing the position during shipping and transport. The bracket must be removed before conducting any service work.

How to use the transportation bracket is described further in [Transportation bracket on page 54](#).



WARNING

The robot is likely to be mechanically unstable if not secured to the foundation.

3 Installation and commissioning

3.2.3 Transportation bracket

3.2.3 Transportation bracket

Location of the transportation bracket

At delivery, the robot is locked in the correct position with the transportation brackets for securing the position during shipping and transport. The transportation brackets cannot be removed until the robot is secured to the foundation.



Note

Keep the brackets every time when it's removed from the robot for further use.

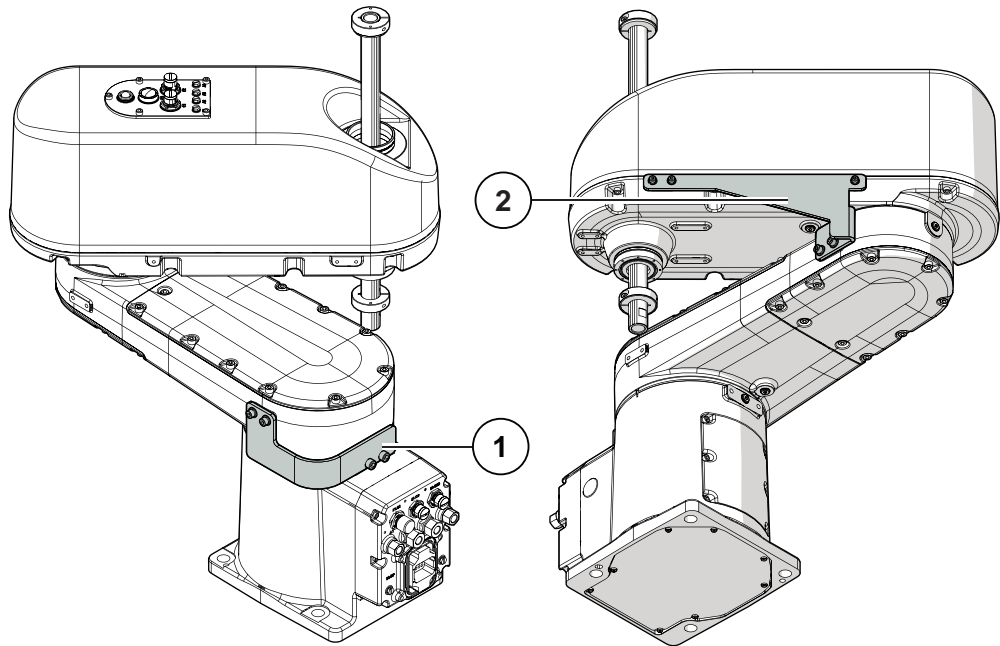

xx2000001151

1	Base inner arm fixture
2	Inner arm outer arm fixture

Removing the transportation bracket

	Action	Note
1	 CAUTION For robots with protection type Clean Room Always cut the paint with a knife and grind the paint edge when disassembling parts of the robot! See Cut the paint or surface on the robot before replacing parts on page 118.	
2	Remove the screws.	
3	Remove the bracket.	

3.3 On-site installation

3.3.1 Brief installation procedure

Introduction

This procedure is a brief guide when installing the robot for the first time. Also see [Pre-installation procedure on page 52](#).

First installation

Use these procedures to install the IRB 920.

	Action	Note
1	Transport the manipulator to its intended location.	
2	Install the valid platform or prepare the foundation for the manipulator.	
3	Lift and secure the manipulator to the platform/foundation.	See Lifting the robot on page 57 . See Orienting and securing the robot on page 65 .
4	Connect the manipulator to the controller.	See <ul style="list-style-type: none"> • <i>Product manual - OmniCore C30</i> • <i>Product manual - OmniCore C90XT</i> • <i>Product manual - OmniCore E10</i>
5	Configure the safety settings.	See <ul style="list-style-type: none"> • <i>Product manual - OmniCore C30</i> • <i>Product manual - OmniCore C90XT</i> • <i>Product manual - OmniCore E10</i>
6	How to start and run the robot is described in the product manual for the controller.	See <ul style="list-style-type: none"> • <i>Product manual - OmniCore C30</i> • <i>Product manual - OmniCore C90XT</i> • <i>Product manual - OmniCore E10</i>
7	Install required equipment, if any.	
8	 DANGER Make sure all safety requirements are met when performing the first test run.	

3 Installation and commissioning

3.3.2 Test run after installation, maintenance, or repair

3.3.2 Test run after installation, maintenance, or repair

Safe handling

Use the following procedure after installation, maintenance, or repair, before initiating motion.



DANGER

Initiating motion without fulfilling the following aspects, may increase the risk for injury or cause damage to the robot.

	Action
1	Remove all tools and foreign objects from the robot and its working area.
2	Verify that the robot is properly secured to its position by all screws, before it is powered up.
3	Verify that any safety equipment installed to secure the position or restrict the robot motion during service activity is removed.
4	Verify that the fixture and work piece are well secured, if applicable.
5	Verify that all safety equipment is installed, as designed for the application.
6	Verify that no personnel are inside the safeguarded space.
7	If maintenance or repair has been done, verify the function of the part that was maintained.
8	Verify the application in the operating mode manual reduced speed.

Collision risks



CAUTION

When programming the movements of the robot, always identify potential collision risks before initiating motion.

3.3.3 Lifting the robot

3.3.3.1 Lifting the robot by two people

General

This section describes how to lift the robot and move it by two people.



WARNING

The transportation brackets cannot be removed until the robot is secured to the foundation.

Grasping location

Grasp the robot with one hand supporting at the housing and the other hand holding the base.

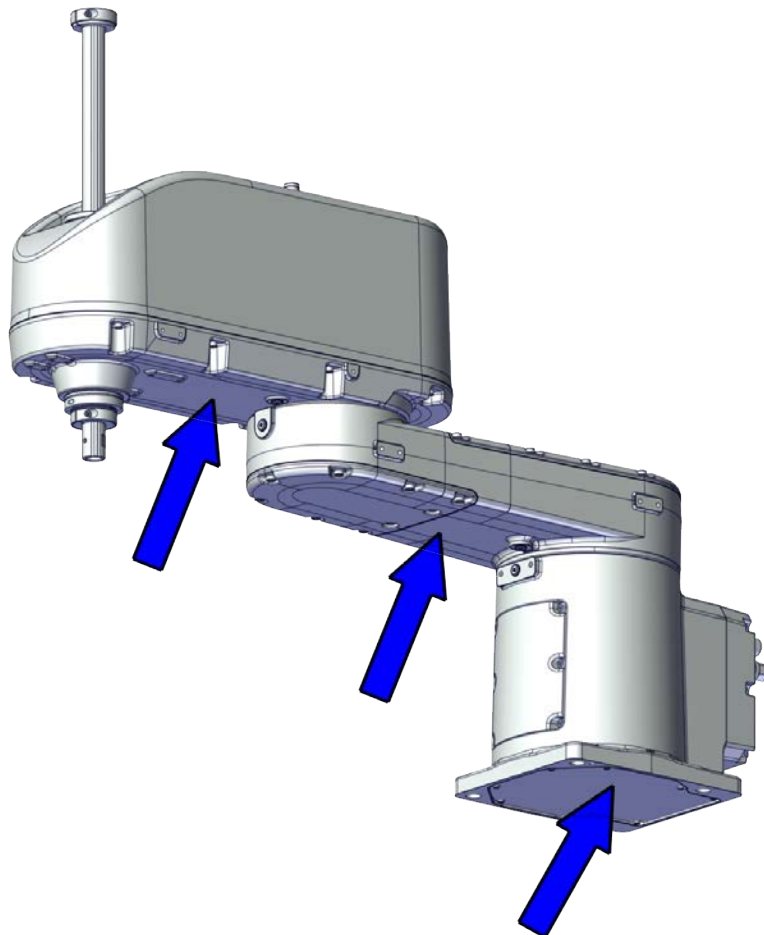

xx2000001156



Continues on next page

3 Installation and commissioning

3.3.3.1 Lifting the robot by two people

Continued

Lifting and transporting the robot

	Action
1	<p> CAUTION</p> <p>The IRB 920 weighs, IRB 920T-6/0.45: 22 kg IRB 920T-6/0.55: 23 kg IRB 920T-6/0.65: 24 kg and can be lifted by two people.</p> <p> CAUTION</p> <p>Do not grasp the ball screw during the lifting work, it may be damaged.</p>
2	Grasp the robot, see Grasping location on page 57 .
3	Lift the robot.
4	<p>Move the robot to desired position.</p> <p> CAUTION</p> <p>Be careful so that the robot does not bump into something while lifting and transporting. It could damage the robot.</p>
5	Secure the robot on a workbench according to section Orienting and securing the robot on page 65 .

3.3.3.2 Lifting robot with lifting accessories

Illustration - attaching the roundslings

Only IRB 920T-6/0.55 and IRB 920T-6/0.65 can be lifted with lifting accessories.

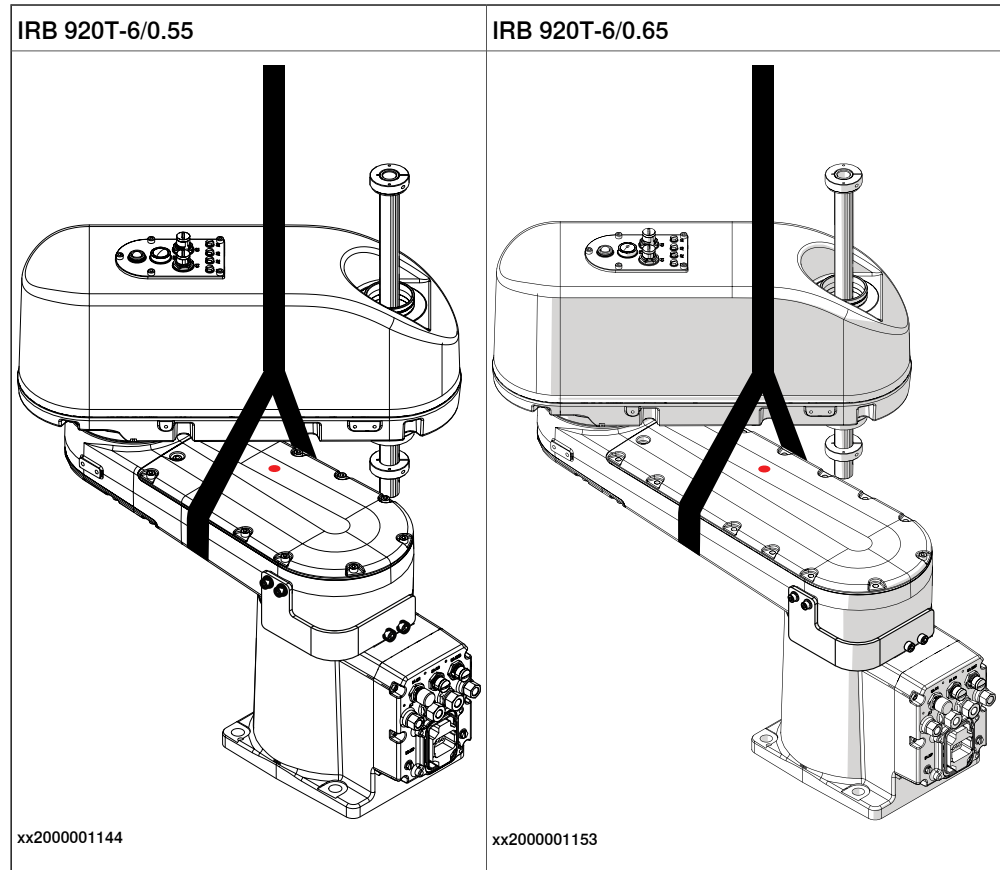

DANGER

Attempting to lift a robot in any other position than the recommended lifting position may result in the robot tipping over, causing severe damage or injury.

Required tools and equipment

Equipment	Article number	Note
Overhead crane	-	
Roundslings, 2 m	-	Length: 2 m. Lifting capacity: 100 kg.
Roundslings, 2.5 m	-	Length: 2.5 m. Lifting capacity: 2,000 kg.

Continues on next page

3 Installation and commissioning

3.3.3.2 Lifting robot with lifting accessories

Continued





Lifting the robot



WARNING

The transportation brackets cannot be removed until the robot is secured to the foundation.

Use this procedure to lift the robot.

	Action	Note
1	<p>Move the robot to the appropriate lifting position.</p>  WARNING <p>The robot is mechanically unstable if not secured to the foundation.</p>	
2	 CAUTION <p>For Clean Room robots, it is important not to rub against the paint of the robot while performing any service work on the robot.</p>	
3	 CAUTION <p>The weight of the IRB 920 robot is 22 kg All lifting accessories used must be sized accordingly.</p>	
4	 WARNING <p>Personnel must not, under any circumstances, be present under the suspended load.</p>	

Continues on next page

3 Installation and commissioning

3.3.3.2 Lifting robot with lifting accessories

Continued

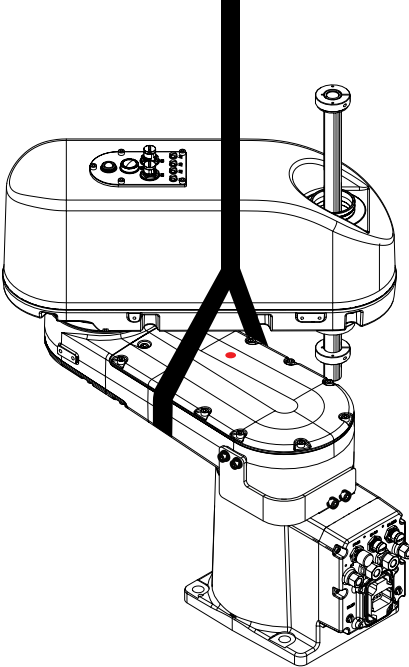
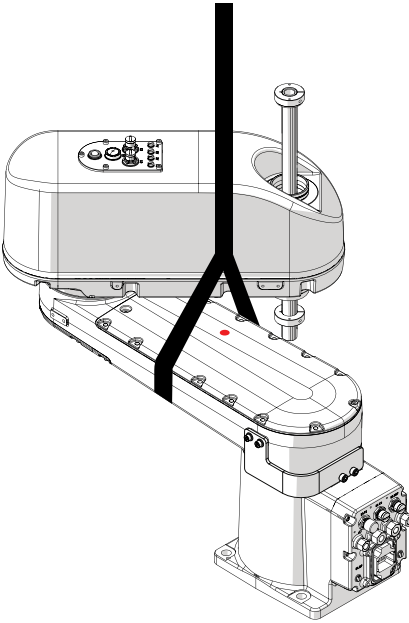
	Action	Note
5	Attach the lifting roundslings to the robot.	<p>Lifting capacity for the lifting chain is specified in Required tools and equipment on page 59.</p> <p>Valid for IRB 920T-6/0.55</p>  <p>xx2000001144</p> <p>Valid for IRB 920T-6/0.65</p>  <p>xx2000001153</p>

Continues on next page

3 Installation and commissioning

3.3.3.2 Lifting robot with lifting accessories

Continued

	Action	Note
6	Carefully stretch the roundslings by lifting the crane slowly. This prevents the robot from falling down when it is unfastened. Do not overstretch the roundslings if the robot is fastened because there is a risk of the robot being damaged.	
7	Remove the robot attachment screws (if the robot is fastened).	Screw: M12x35 (robot installation directly on foundation) (4 pcs)
8	Raise the overhead crane to lift the robot.	

3.3.4 Manually releasing the brakes

Introduction to manually releasing the brakes

This section describes how to release the holding brakes for the axes motors.

Location of the brake release unit

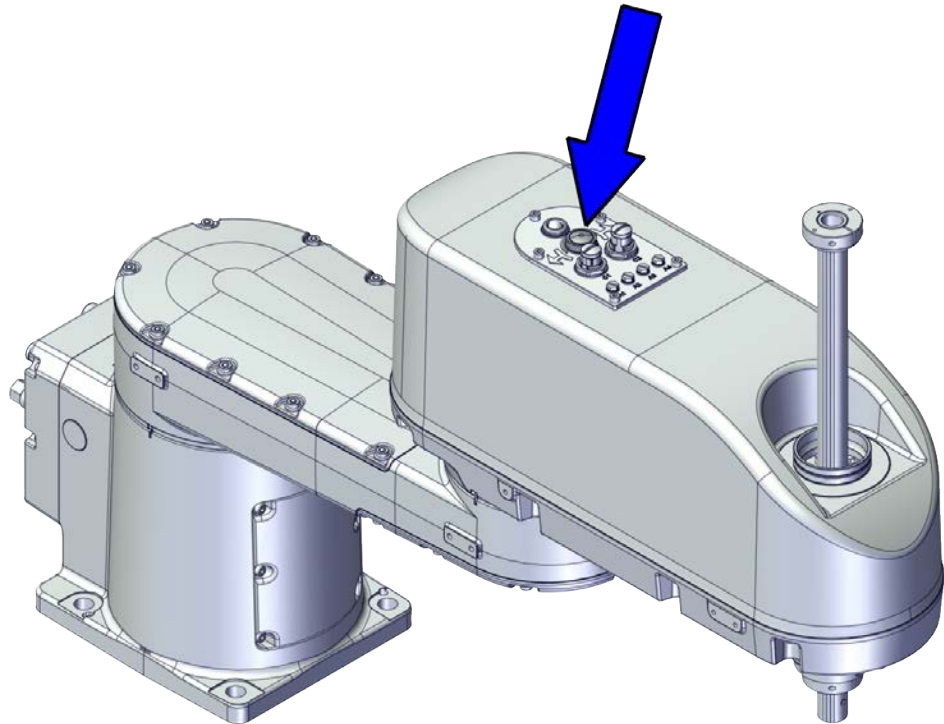

The brake release unit is located as shown in the figure.



xx2000001154

Releasing the brakes

This procedure describes how to release the holding brakes when the robot is equipped with a brake release unit.

	Action	Note
1	 Note If the robot is not connected to the controller, power must be supplied to the connector R1.MP according to the section Supplying power to connector R1.MP on page 64 .	
2	 DANGER When releasing the holding brakes, the robot axes may move very quickly and sometimes in unexpected ways. Make sure no personnel is near or beneath the robot.	

Continues on next page

3 Installation and commissioning

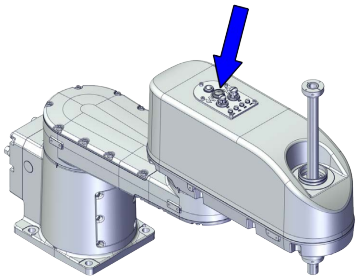

3.3.4 Manually releasing the brakes

Continued

	Action	Note
3	<p>Release the holding brake of all axes by pressing the brake release button.</p> <p>The brake will be enable as soon as the button is released.</p> <p> WARNING</p> <p>Pressing the brake release button will release the holding brakes on all axes simultaneously.</p>	 <p>xx2000001154</p>

Supplying power to connector R1.MP

If the robot is not connected to the controller, power must be supplied to connector R1.MP on the robot, in order to enable the brake release buttons.

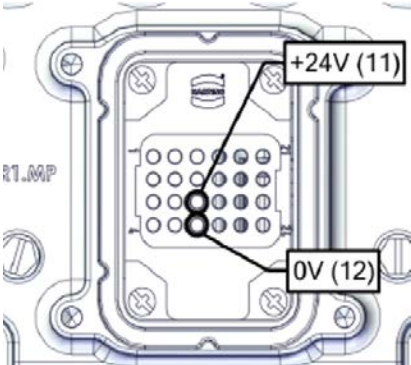
	Action	Note
1	<p> DANGER</p> <p>Incorrect connections, such as supplying power to the wrong pin, may cause all brakes to be released simultaneously and instantly!</p>	
2	<p>Supply</p> <ul style="list-style-type: none"> • 0V on pin 12. • 24V on pin 11. <p> Note</p> <p>Do not interchange the 24V and 0V pins. If they are mixed up, damage can be caused to internal electrical components.</p>	 <p>xx2000001136</p>
3	<p>Use the brake releasing button as described in Releasing the brakes on page 63.</p>	

3.3.5 Orienting and securing the robot

General

This section describes how to orient and secure the robot to the base plate or foundation in order to run the robot safely.



Attachment screws

The table below specifies the type of securing screws and washers to be used for securing the robot to the base plate/foundation.

Suitable screws	M12x35 (robot installation directly on foundation)
Quantity	4 pcs
Quality	8.8
Suitable washer	24 x 13 x 2.5, steel hardness class 200HV
Guide pins	2 pcs, D6, ISO 2338 - 6m6x20 - A1
Tightening torque	56 Nm±5.6 Nm
Length of thread engagement	Minimum 17 mm for ground with material yield strength 150 MPa
Level surface requirements	0.1/500 mm

Securing a floor mounted robot

Use this procedure to orient and secure the robot floor mounted.

	Action	Note
1	Make sure the installation site for the robot conforms to the specifications in section Technical data on page 38 .	
2	Prepare the installation site with attachment holes. The foundation surface must be clean and unpainted.	The hole configuration of the base is shown in the figure in Hole configuration, base on page 66 .
3	 CAUTION The weight of the IRB 920 robot is IRB 920T-6/0.45: 22 kg IRB 920T-6/0.55: 23 kg IRB 920T-6/0.65: 24 kg All lifting accessories used must be sized accordingly.	
4	 CAUTION When the robot is put down after being lifted or transported, there is a risk of it tipping, if not properly secured.	
5	Lift the robot.	See Lifting the robot on page 57 .
6	Fit two pins to the holes in the base.	2 pcs, D6, ISO 2338 - 6m6x20 - A1

Continues on next page

3 Installation and commissioning

3.3.5 Orienting and securing the robot

Continued

	Action	Note
7	Guide the robot gently, using the attachment screws while lowering it into its mounting position.	Make sure the robot base is correctly fitted onto the pins.
8	Fit the securing screws and washers in the attachment holes of the base.	Screws: M12x35 (robot installation directly on foundation), 4 pcs, quality 8.8 Washers: 24 x 13 x 2.5, steel hardness class 200HV
9	Tighten the bolts in a crosswise pattern to ensure that the base is not distorted.	Tightening torque: 56 Nm±5.6 Nm

Hole configuration, base

This illustration shows the hole configuration used when securing the robot.

Illustration for rear outlet cable version:

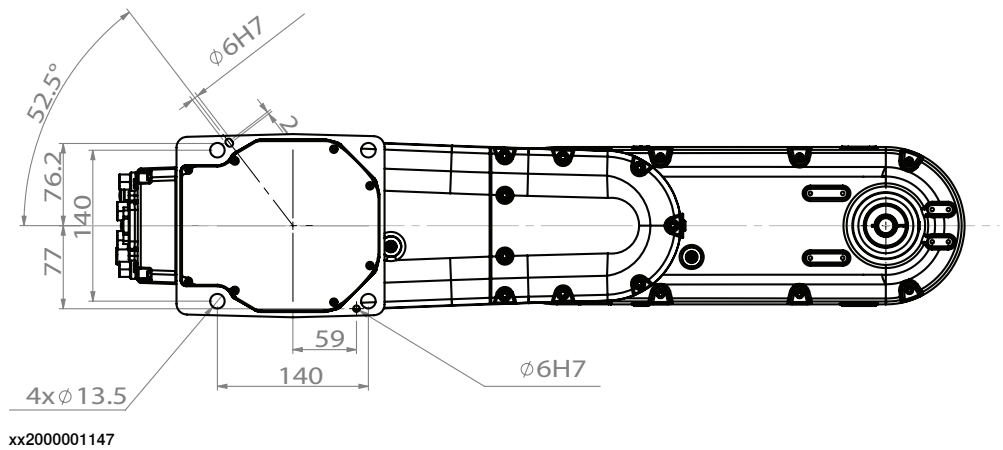

Continues on next page

3 Installation and commissioning

3.3.5 Orienting and securing the robot

Continued

Illustration for underneath outlet cable version:

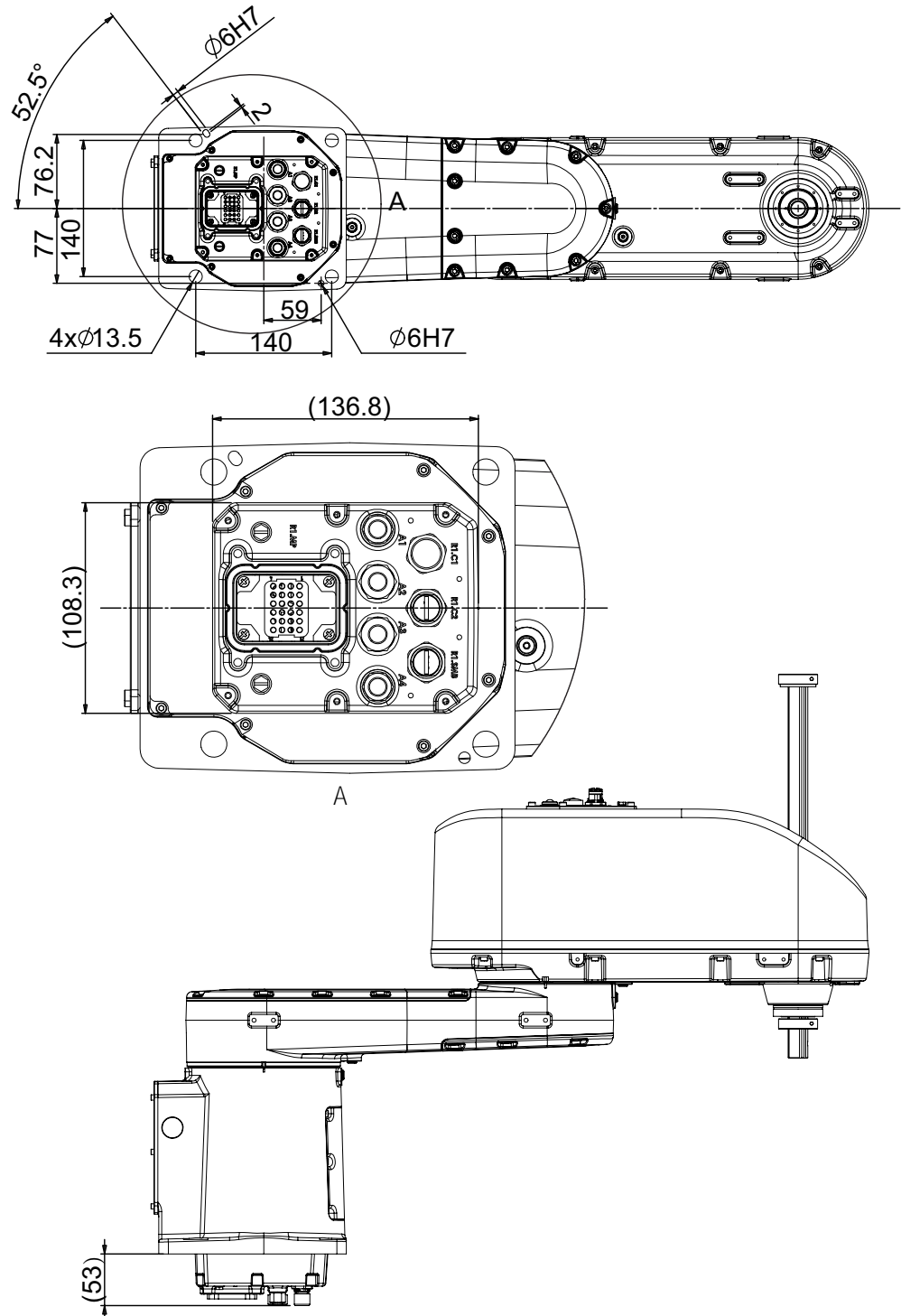

xx2000001148

3 Installation and commissioning

3.3.6 Loads fitted to the robot, stopping time and braking distances

3.3.6 Loads fitted to the robot, stopping time and braking distances

Define loads carefully

Any loads mounted on the robot must be defined correctly and carefully (with regard to the position of center of gravity and mass moments of inertia) in order to avoid jolting movements and overloading motors, gears and structure.



CAUTION

Incorrectly defined loads may result in operational stops or major damage to the robot.

Load diagrams, permitted extra loads (equipment) and their positions are specified in the product specification. The loads must be defined in the software.

Stopping time and braking distances

The performance of the motor brake depends on if there are any loads attached to the robot.

See *Product specification - Robot stopping distances according to ISO 10218-1*.

3.3.7 Lamp

3.3.7.1 Lamp on the robot

Description

A lamp with a yellow fixed light is installed on the robot.

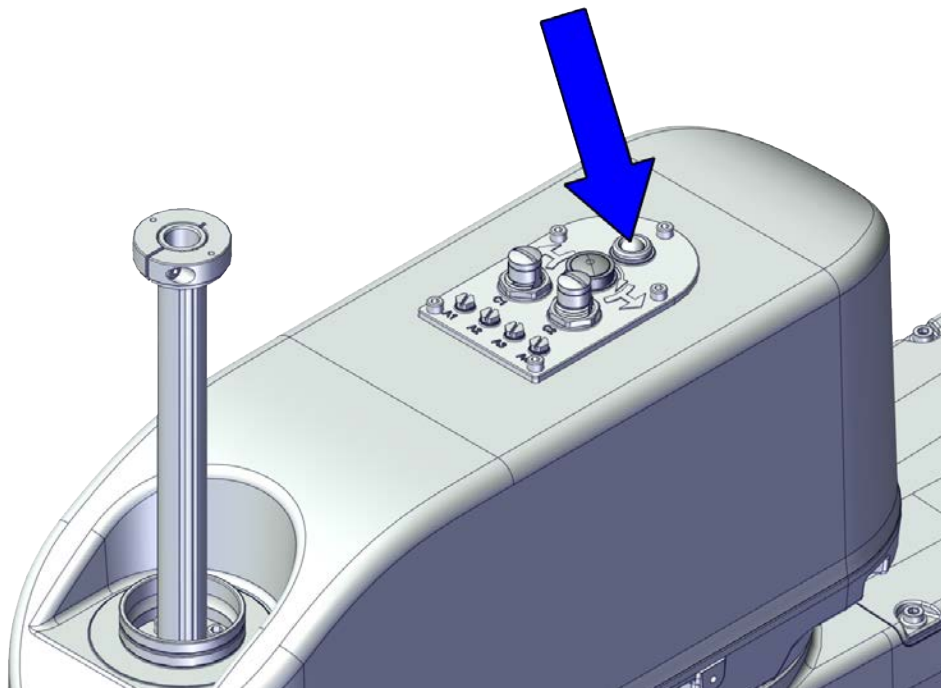

xx2100002507

Function

The lamp is active in MOTORS ON mode.



Note

This function is NOT valid when connecting to OmniCore E10.

Further information

Further information about the MOTORS ON/MOTORS OFF mode may be found in the product manual for the controller.

3 Installation and commissioning

3.3.7.2 Installation of signal lamp (option)

3.3.7.2 Installation of signal lamp (option)



Description

A signal lamp with a yellow fixed light can be mounted in the cell or any other visible location, and driven by I/O signal or MON_LAMP signal from the controller.



Function

The lamp is active in MOTORS ON mode.

Installation of signal lamp from I/O signal

	Action
1	 DANGER Make sure that all supplies for electrical power, hydraulic pressure, and air pressure are turned off.
2	For robots with OmniCore C line Connect the lamp cable connector to the local I/O connector on the controller.  Note The local I/O connectors provides 16 digital output signals for use.
3	For robots with OmniCore E line Connect the lamp cable connector to the I/O connector on the controller.  Note The I/O connectors provides 8 digital output signals for use.
4	Configure the lamp by adding a <i>System Output</i> type signal with status set to <i>Motors On State</i> .
5	The lamp is now ready for use and is lit in MOTORS ON mode.

Installation of signal lamp from MON_LAMP signal

	Action
1	 DANGER Make sure that all supplies for electrical power, hydraulic pressure, and air pressure are turned off.
2	For robots with OmniCore C line Connect the lamp cable connector to the X15 connector on the controller.  Note The X15 connector provides MON_LAMP output signals for use. For more details, see chapter <i>Descriptions for connectors</i> in OmniCore product manuals.

Continues on next page

	Action
3	<p>For robots with OmniCore E line Connect the lamp cable connector to the MON connector on the controller.</p> <p> Note</p> <p>The MON connector provides MON_LAMP output signals for use. For more details, see chapter <i>Descriptions for connectors</i> in OmniCore product manuals.</p>
4	The lamp is now ready for use and is lit in MOTORS ON mode.

Further information

Further information about the MOTORS ON/MOTORS OFF mode may be found in the product manual for the controller.

Further information about how to set up I/O system may be found in *Technical reference manual - System parameters*.

3 Installation and commissioning

3.3.8 Fitting equipment on the robot (robot dimensions)

3.3.8 Fitting equipment on the robot (robot dimensions)

Attachment holes and dimensions

Extra loads can be mounted on robot. Definitions of dimensions and masses are shown in the following figures. The robot is supplied with holes for fitting extra equipment.

Maximum allowed arm load depends on center of gravity of arm load and robot payload.

Holes for fitting extra equipment

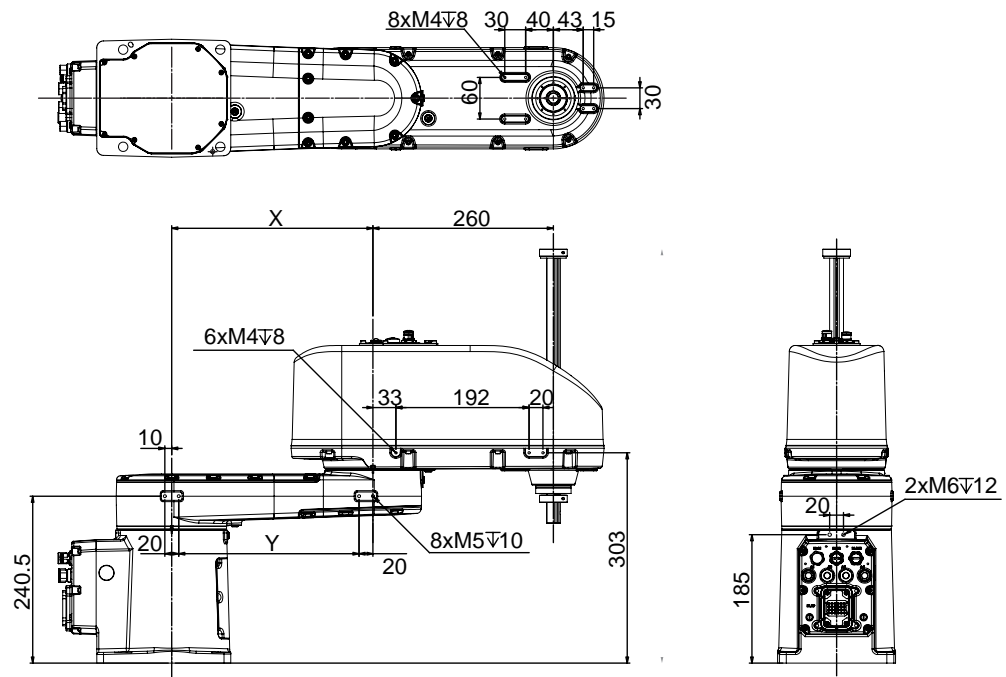

xx2000001149

	0.45_0.18	0.45_0.3	0.55_0.18	0.55_0.3	0.65_0.18	0.65_0.3
X	190 mm	190 mm	290 mm	290 mm	390 mm	390 mm
Y	160 mm	160 mm	260 mm	260 mm	360 mm	360 mm

Fitting of end effector to the ball screw spline shaft

An end effector can be attached to the lower end of the shaft of the ball screw spline unit. The dimensions for fitting the end effector is shown in the following figure.



Note

Mounting of other equipment on the IRB 920 may damage the gearboxes.

Continues on next page

3 Installation and commissioning

3.3.8 Fitting equipment on the robot (robot dimensions)

Continued

Robots with protection class IP30 3350-300

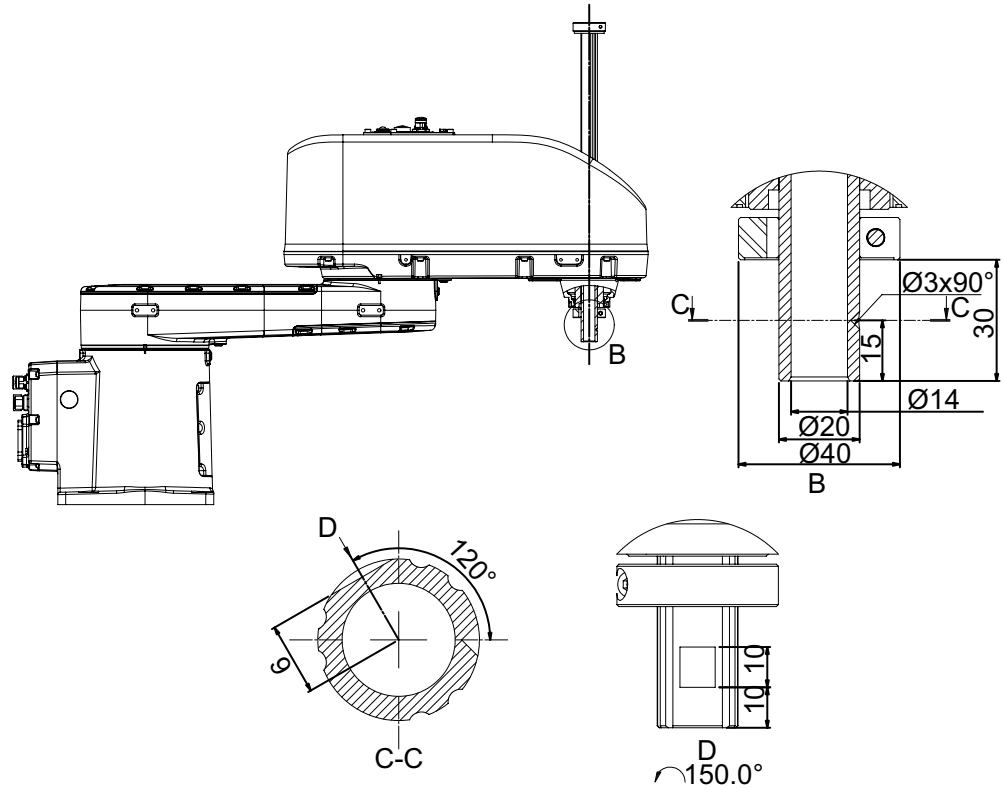

xx2000001157

Robots with protection class IP54 (option 3350-540) or with protection type Clean Room (option 3351-5)

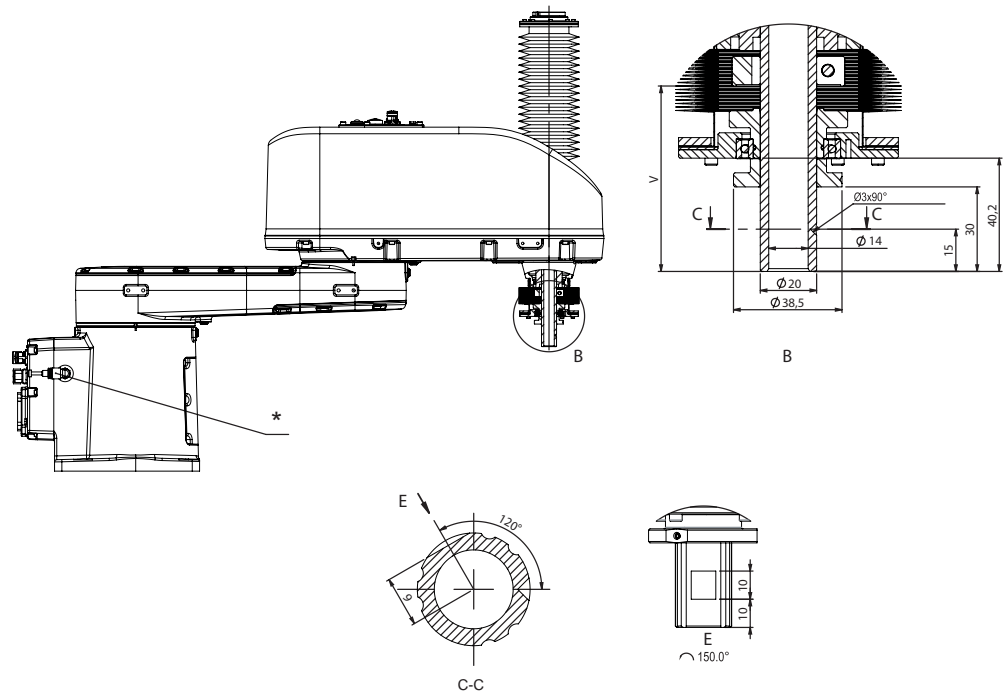

xx2100002394

*: For Clean Room only.

Continues on next page

3 Installation and commissioning

3.3.8 Fitting equipment on the robot (robot dimensions)

Continued

	0.45_0.18	0.45_0.3	0.55_0.18	0.55_0.3	0.65_0.18	0.65_0.3
V	65.8 mm	80.8 mm	65.8 mm	80.8 mm	65.8 mm	80.8 mm

Fastener quality

When fitting tools on the tool flange, only use screws with quality 12.9. For other equipment use suitable screws and tightening torque for your application.

3.4 Restricting the working range

3.4.1 Adjusting the working range

Reasons for adjusting the manipulator working range

The working range of each manipulator axis is configured in the software. If there is a risk that the manipulator may collide with other objects at installation site, its working space should be limited. The manipulator must always be able to move freely within its entire working space.

Working range configurations

The parameter values for the axes working range can be altered within the allowed working range and according to available options for the robot, either to limit or to extend a default working range. Allowed working ranges and available options for each manipulator axis are specified in [Working range on page 44](#).

Mechanical stops on the manipulator

Mechanical stops are and can be installed on the manipulator as limiting devices to ensure that the manipulator axis does not exceed the working range values set in the software parameters.



Note

The mechanical stops are only installed as safety precaution to physically stop the robot from exceeding the working range set. A collision with a mechanical stop always requires actions for repair and troubleshooting.

Axis	Fixed mechanical stop ⁱ	Movable mechanical stop ⁱⁱ
Axis 1	yes	no
Axis 2	yes	no
Axis 3	yes	yes
Axis 4	no	no

ⁱ Part of the casting or fixed on the casting and can not /should not be removed.

ⁱⁱ Can be installed in a different position to ensure a reduced working range.

3 Installation and commissioning

3.4.2 Mechanically restricting the working range

3.4.2 Mechanically restricting the working range

Axis-1 mechanical stops

Location of the mechanical stop

The figures shows where the axis-1 mechanical stop is placed on the robot.

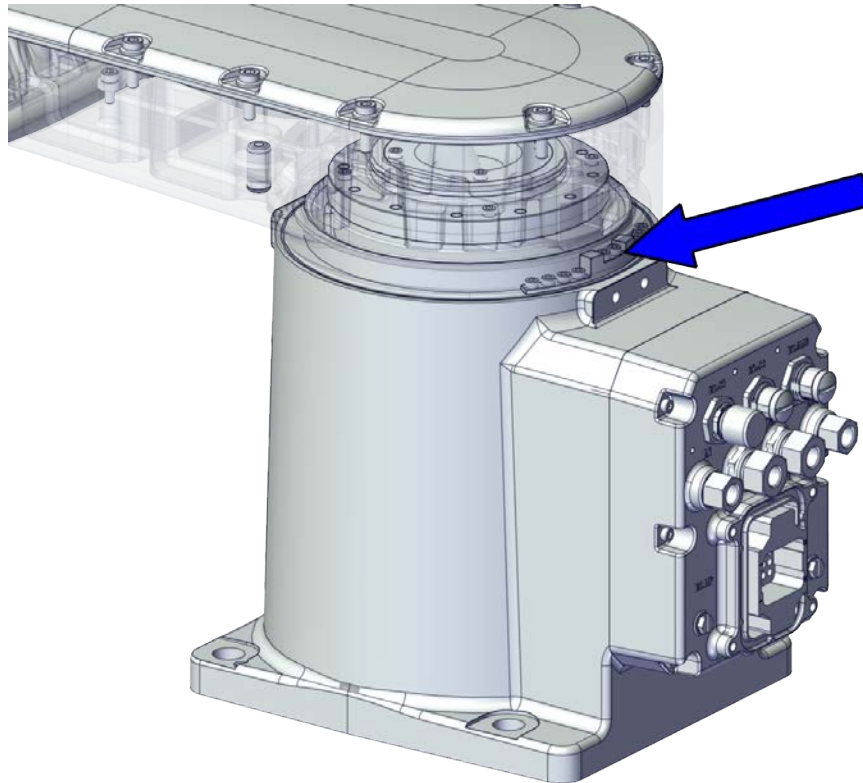

xx2000001159

Required spare parts



Note

The spare part numbers that are listed in the table can be out of date. See the latest spare parts of the IRB 920 via myABB Business Portal, www.abb.com/myABB.

Spare part	Article number	Note
Block	3HAC075320-001	

Replacement of the axis-1 mechanical stop

For more details about replacing the axis-1 mechanical stop, see [Removing the block from the base on page 231](#).

Continues on next page

Axis 3 mechanical stops

Location of the mechanical stops

The figures shows where the axis 3 mechanical stops are placed on the robot.

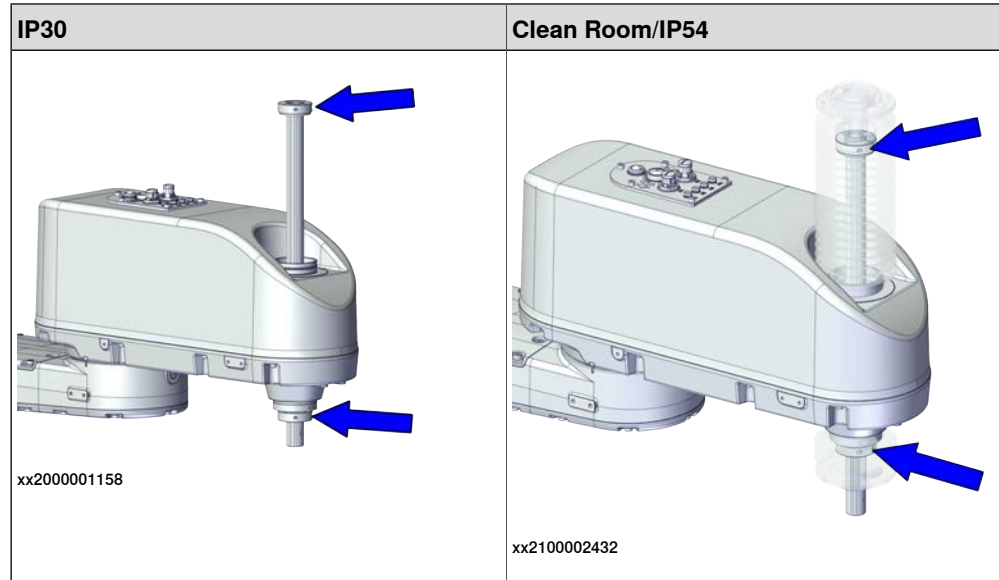

CAUTION

For the robots with protection type Clean Room and protection class IP54, the mechanical stops are inside the bellows. If needed, remove the bellows to inspect the ball screw spline unit.

For the details on removing the bellows, refer to [Replacing the bellows](#).

Required spare parts



Note

The spare part numbers that are listed in the table can be out of date. See the latest spare parts of the IRB 920 via myABB Business Portal, www.abb.com/myABB.

Spare part	Article number	Note
Mechanical-Stop top, D20	3HAC073068-001	With bolt
Mechanical-Stop bottom, D20	3HAC073069-001	With bolt

Replacement of the axis-3 mechanical stop

For more details about replacing the axis-3 mechanical stop, see [Replacing the mechanical stopper on page 398](#).

3 Installation and commissioning

3.5.1 Robot cabling and connection points

3.5 Electrical connections

3.5.1 Robot cabling and connection points

Introduction

Connect the robot and controller to each other after securing them to the foundation. The lists below specify which cables to use for each respective application.



DANGER

Turn off the main power before connecting any cables.



CAUTION

Verify that the robot serial number is according to the number(s) in the *Declaration of Incorporation (DoI)*.

Main cable categories

The following table specifies cabling categories between the robot and the controller. Some of the cabling belong to optional applications.

Cable category	Description
Robot cables	Handles power supply to and control of the robot's motors as well as feedback from the serial measurement board. Specified in the table Robot cables on page 78 .
Customer cables	Handles communication with equipment fitted on the robot by the customer, low voltage signals and high voltage power supply + protective ground. The customer cables also handle databus communication. The customer cables also include the air hose. See the product manual for the controller, see document number in References on page 10 .
Air hoses	The hose for compressed air is integrated with the manipulator cable harness.

Robot cables

These cables are included in the standard delivery. They are completely pre-manufactured and ready to plug in.

Cable sub-category	Description	Connection point, cabinet	Connection point, robot
Robot cables, power	Transfers drive power from the drive units in the control cabinet to the robot motors.	X1	R1.MP ⁱ
Robot cable, signals	Transfers resolver data from and power supply to the serial measurement board.	X2	R1.SMB

ⁱ An O-ring is needed for the robots with protection type Clean Room and protection class IP54.

Continues on next page



Note

Install the O-ring (3HAB3772-19) for the haring connector when connect the power cable for the robots with protection type Clean Room and protection class IP54.

Robot cable, power

Power cable length	Article number
Power cable, straight connector, 3 m	3HAC077245-001
Power cable, straight connector, 7 m	3HAC077245-002
Power cable, straight connector, 15 m	3HAC077245-003
Power cable, angled connector, 3 m	3HAC077247-001
Power cable, angled connector, 7 m	3HAC077247-002
Power cable, angled connector, 15 m	3HAC077247-003

Robot cable, signals

Signal cable length	Article number
Signal cable, shielded: 3 m	3HAC067446-001
Signal cable, shielded: 7 m	3HAC067446-002
Signal cable, shielded: 15 m	3HAC067446-003

Bending radius for static floor cables

The minimum bending radius is 10 times the cable diameter for static floor cables.

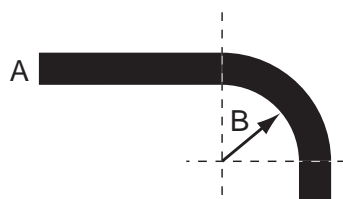

xx1600002016

A	Diameter
B	Diameter x10

Continues on next page

3 Installation and commissioning

3.5.1 Robot cabling and connection points

Continued

Grounding and bonding point on manipulator

There is a grounding/bonding point on the manipulator base. The grounding/bonding point is used for potential equalizing between control cabinet, manipulator and any peripheral devices.

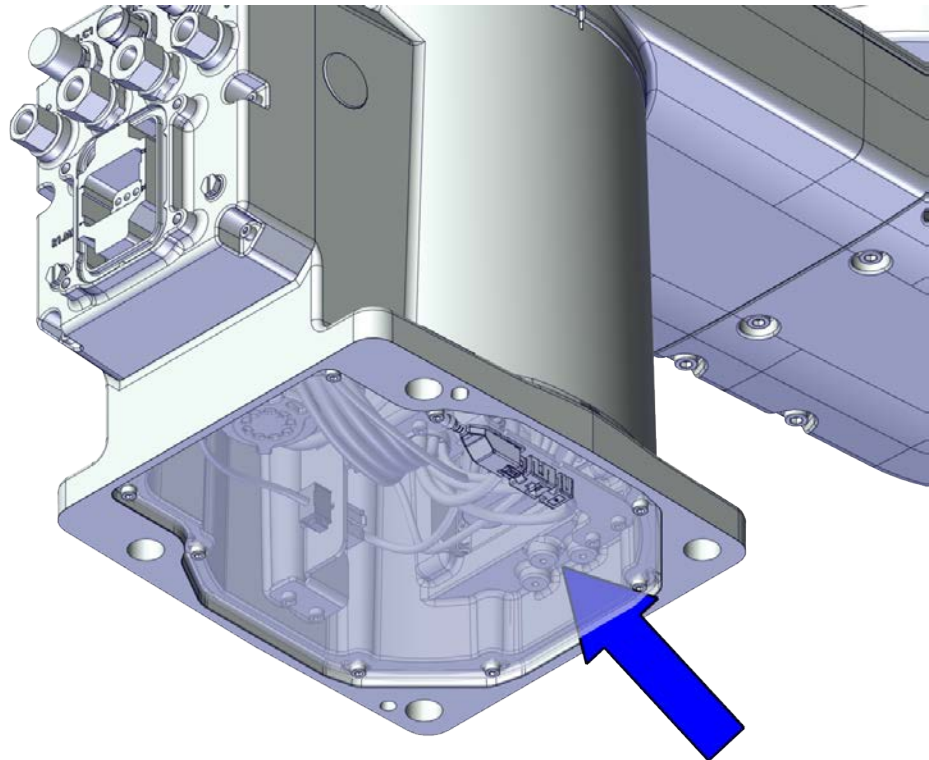

xx2000001160

Figure 3.1:

Customer cables - CP/CS cable

CP/CS cable length	Article number ⁱ
3 m	3HAC067449-001
7 m	3HAC067449-002
15 m	3HAC067449-003

ⁱ It is recommended to always use the CP/CS cable provided by ABB. If users still require to do wiring by their own, make sure to use R1.C1 connector in M12 A-code 12p female type. It is the responsibility of the users to guarantee the safety of the system when self-prepared cables and connectors are used.

Customer cables - Ethernet floor cable

Ethernet floor cable length	Article number ⁱ
7 m	3HAC067447-002
15 m	3HAC067447-003

ⁱ It is recommended to always use the Ethernet floor cable provided by ABB. If users still require to do wiring by their own, make sure to use R1.C2 connector in M12 X-code male type. It is the responsibility of the users to guarantee the safety of the system when self-prepared cables and connectors are used.

3.5.2 Customer connections

Introduction to customer connections

The cables for customer connection are integrated in the robot and the connectors are placed at the outer arm and base. There are two connectors C1/C2 at the outer arm. Corresponding connector R1.C1/R1.C2 are located at the base.

Hose for compressed air is also integrated into the manipulator. There are 4 inlets at the base (R1/8") and 4 outlets (M5) on the outer arm.

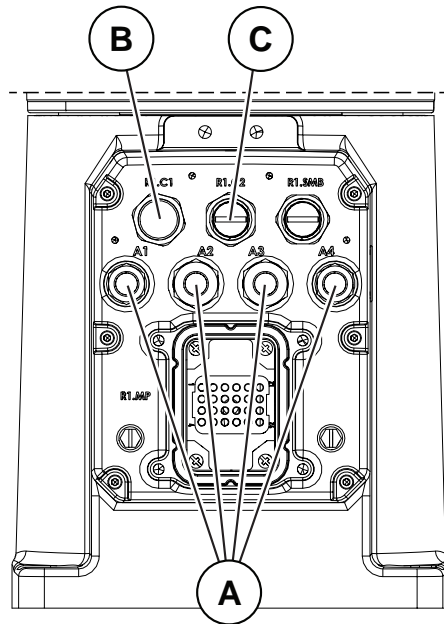

xx2000001161

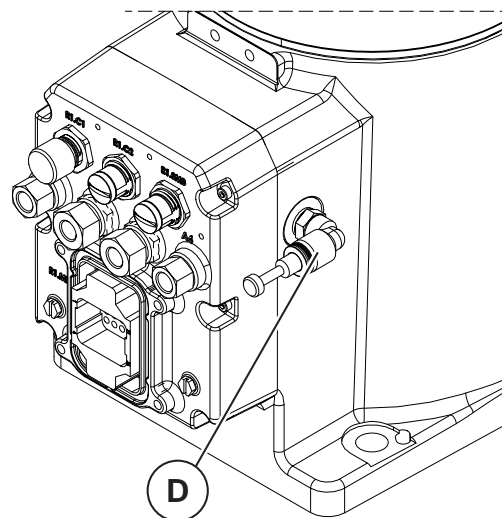
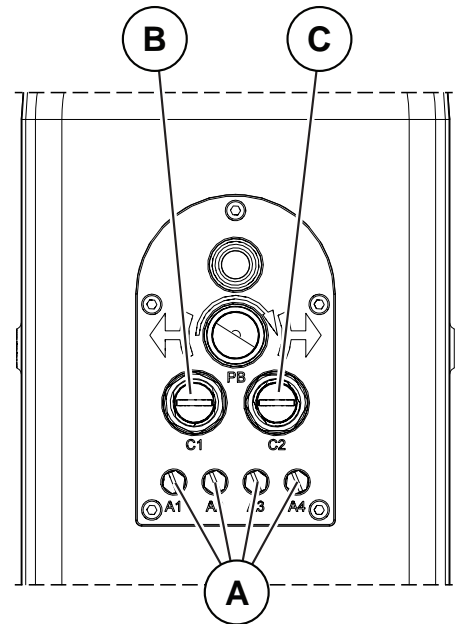

xx2100002441

Continues on next page

3 Installation and commissioning

3.5.2 Customer connections

Continued

Position	Connection	Description	Number	Value
A	Air	Max. 6 bar	4	Air hose with outer diameter 4 mm, 2 pcs Air hose with outer diameter 6 mm, 2 pcs
B	C1	Customer power/signal	12 wires	30 V, 1.5 A
C	C2	Customer power/signal or ethernet	8 wires	30 V, 1 A or 1 Gbits/s
D	EP	Exhaust port ⁱ	1	Φ8 , 7~9L/min ⁱⁱ

ⁱ Only available for protection type Clean Room.

ⁱⁱ To avoid the deformation of bellows, reduce the air flow if necessary.

Connector kits (optional)

Connector kits, base

R1.C1 and R1.C2 connectors on the base are parts of the CP/CS cable and Ethernet floor cable, respectively. For details about the robot cabling, see [Robot cabling and connection points on page 78](#).

Connector kits, outer arm

The table describes the CP/CS and Ethernet (if any) connector kits for the outer arm.

Position	Description		Art. no.
Connector kits	CP/CS	M12 CPCS Male straight connector kits	3HAC066098-001
		M12 CPCS Male angled connector kits	3HAC066099-001
	Ethernet	M12 Ethernet Cat5e Male straight connector kits	3HAC067413-001
		M12 Ethernet Cat5e Male angled connector kits	3HAC067414-001

Continues on next page

Protection covers

Protection covers for water and dust proofing

Protection covers are delivered together with the robot and must be well fitted to the connectors in any application requiring water and dust proofing.

Always remember to refit the protection covers after removing them.

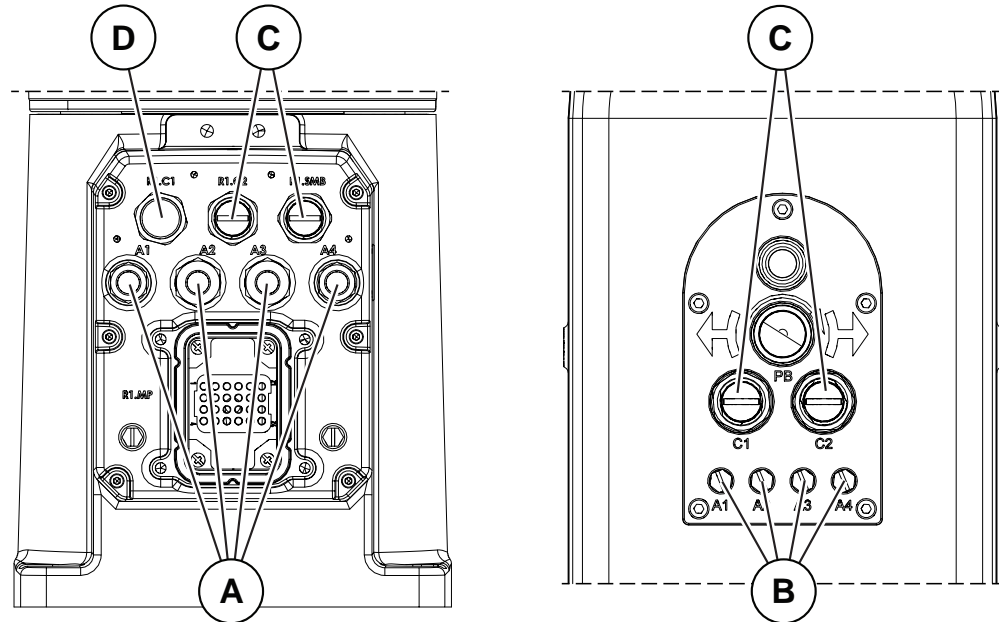

xx2000001162

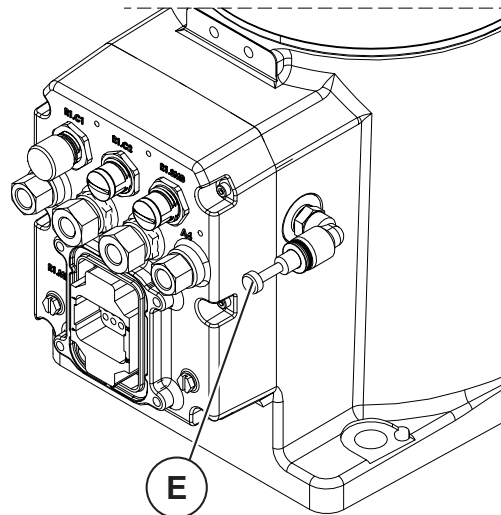

xx2100002442

A	Protection covers for air hose connector on the base
B	Protection covers for air hose connector on the process hub
C	Protection covers for C2/SMB connector on the base and C1/C2 connector on the process hub
D	Protection cover for C1 connector on the base

Continues on next page

3 Installation and commissioning

3.5.2 Customer connections

Continued

E	Protection plug for exhaust port connector on the base ⁱ
---	---

ⁱ Only available for protection type Clean Room.

4 Maintenance

4.1 Introduction

Structure of this chapter

This chapter describes all the maintenance activities recommended for the IRB 920.

It is based on the maintenance schedule found at the beginning of the chapter. The schedule contains information about required maintenance activities including intervals, and refers to procedures for the activities.

Each procedure contains all the information required to perform the activity, including required tools and materials.

The procedures are gathered in different sections and divided according to the maintenance activity.

Safety information

Observe all safety information before conducting any service work.

There are general safety aspects that must be read through, as well as more specific safety information that describes the danger and safety risks when performing the procedures. Read the chapter [Safety on page 15](#) before performing any service work.

The maintenance must be done by qualified personnel in accordance with the safety requirements set forth in the applicable national and regional standards and regulations.



Note

If the IRB 920 is connected to power, always make sure that the IRB 920 is connected to protective earth and a residual current device (RCD) before starting any maintenance work.

For more information see:

- *Product manual - OmniCore C30*
- *Product manual - OmniCore C90XT*
- *Product manual - OmniCore E10*
- [Robot cabling and connection points on page 78.](#)

4 Maintenance

4.2 Service Information System (SIS)

4.2 Service Information System (SIS)

General

Service Information System (SIS) is a software function within the robot controller, which simplifies maintenance of the robot system. It supervises the operating time and mode of the robot, and alerts the operator when a maintenance activity is scheduled.

Troubleshooting

The SIS function *Gearbox* is available for estimating the service interval (remaining lifetime) of the gearboxes of a robot. Such information of the ball screw spline unit of the IRB 920 is reported as **axis 3** in the SIS system. When a service message is reported for axis 3 of the IRB 920, an inspection on the ball screw spline unit is required.

For more information about the SIS function, see *Operating manual - Service Information System*.

4.3 Maintenance schedule and expected component life

4.3.1 Specification of maintenance intervals

Introduction

The intervals are specified in different ways depending on the type of maintenance activity to be carried out and the working conditions of the IRB 920:

- Calendar time: specified in months regardless of whether the system is running or not.
- Operating time: specified in operating hours. More frequent running means more frequent maintenance activities.
- SIS: specified by the robot's SIS (Service Information System). A typical value is given for a typical work cycle, but the value will differ depending on how hard each part is run.

The SIS used in OmniCore is further described in the *Operating manual - OmniCore*.

Robots with the functionality *Service Information System* activated can show active counters in the device browser in RobotStudio, or on the FlexPendant.

4 Maintenance

4.3.2 Maintenance schedule

4.3.2 Maintenance schedule

Scheduled and non-predictable maintenance

The robot must be maintained regularly to ensure proper function. The maintenance activities and intervals are specified in the table below.

Non-predictable situations also give rise to inspections of the robot. Any damage must be attended to immediately.

Life of each component

The inspection intervals *do not* specify the life of each component. Values for these are specified in the section [Expected component life on page 90](#)

Maintenance schedule

Maintenance activities	Regularly	Every 12 months	Every 36 months	Every 100 km	Every 20,000 hours ⁱ	Reference
Cleaning the robot	x					Cleaning the IRB 920 on page 108
Inspecting the robot	x					Check for abnormal wear or contamination.
Inspecting the robot harness	x ⁱⁱ					Inspecting the robot cabling on page 93
Inspecting the information labels		x				Inspecting the information labels on page 91
Inspecting the ball screw spline unit	x					Inspecting the ball screw spline unit on page 94
Inspecting the mechanical stop	x					Inspecting axis-3 mechanical stops on page 97
Inspecting the timing belt		x				Inspecting timing belts on page 100
Lubricating the ball screw spline unit				x		Lubricating the ball screw spline unit on page 106
Replacing the SMB battery pack			x ⁱⁱⁱ			Replacing the battery pack on page 105
Running the <i>Brake Check</i> routine ^{iv}	x ^v					Recommended to robots without the SafeMove option. See <i>Operating manual - OmniCore</i> .
Running the <i>Cyclic Brake Check</i> routine ^{iv}	x ^v					Recommended to robots with the SafeMove option. See <i>Application manual - Functional safety and SafeMove</i> .
Overhaul of complete robot					x	

ⁱ Operating hours counted by the DTC = Duty time counter.

Continues on next page

- ii Replace when damage or cracks is detected or life limit is approaching that specified in section [Expected component life on page 90](#).
- iii The battery is to be replaced at given maintenance interval or at battery low alert.
- iv Not needed separately if already included in the application.
- v Recommended test interval is within the range 8-48 hours.

4 Maintenance

4.3.3 Expected component life

4.3.3 Expected component life

Expected life depends on usage

The expected life of a specific component of the robot can vary greatly depending on how hard it is run.

Expected component life

Component	Expected life	Note
Cable harness, normal usage ⁱ	20000 hours ⁱⁱ	
Cable harness, extreme usage ⁱⁱⁱ	20000 hours ⁱⁱ	
Gearboxes	20000 hours	

ⁱ Examples of "normal usage" in regard to movement: most material handling applications and limited use of bending backwards mode of axis 3.

ⁱⁱ Severe chemical or thermal environments, or similar environments, can result in shortened life expectancy.

ⁱⁱⁱ Examples of "extreme usage" in regard to movement: press tending, very severe palletizing applications, major use of axis 1 movement and major use of bending backwards of axis 3.

4.4 Inspection activities

4.4.1 Inspecting the information labels

Location of labels

These figures show the location of the information labels to be inspected. The symbols are described in section [Safety symbols on manipulator labels on page 19](#).

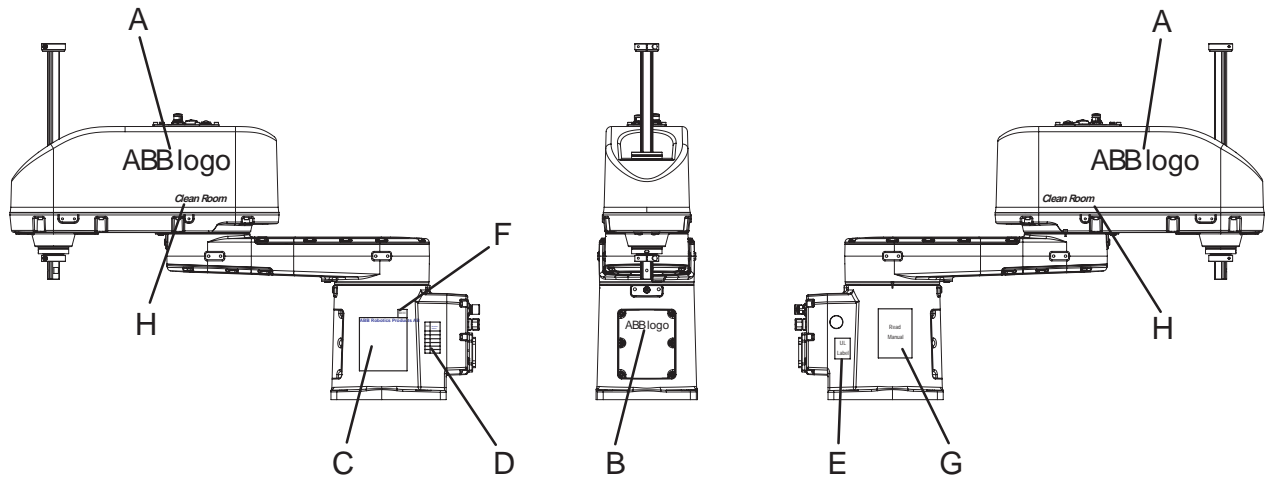

xx2000001143

A	ABB logo (Big size)
B	ABB logo (Small size)
C	Rating label
D	Calibration label
E	UL label
F	WEEE label
G	Read manual and caution

Required tools and equipment

Visual inspection, no tools are required.

Inspecting, labels

Action	Note
<p>1</p> <p> DANGER</p> <p>Turn off all:</p> <ul style="list-style-type: none"> • electric power supply • hydraulic pressure supply • air pressure supply <p>to the robot, before entering the safeguarded space.</p>	
<p>2</p> <p>Inspect the labels, located as shown in the figures.</p>	

Continues on next page

4 Maintenance

4.4.1 Inspecting the information labels

Continued

	Action	Note
3	Replace any missing or damaged labels.	Article numbers for the labels and plate set is specified in Spare parts on page 1001 .

4.4.2 Inspecting the robot cabling

Introduction



CAUTION

For robots with protection type Clean Room

Always read the specific instructions before doing any repair work, see [Cut the paint or surface on the robot before replacing parts on page 118](#)

Required tools and equipment

Visual inspection, no tools are required.

Other tools and procedures may be required if the spare part needs to be replaced. These are specified in the replacement procedure.

Inspection, robot cabling

Use this procedure to inspect the robot cabling.

	Action	Note
1	 DANGER Turn off all: <ul style="list-style-type: none"> • electric power supply to the robot • hydraulic pressure supply to the robot • air pressure supply to the robot Before entering the robot working area.	
2	Visually inspect: <ul style="list-style-type: none"> • the control cabling between the robot and control cabinet • the cabling to motors 1 and 2. Look for abrasions, cuts or crush damage.	
3	Replace the cabling if wear or damage is detected.	

4 Maintenance

4.4.3 Inspecting the ball screw spline unit

4.4.3 Inspecting the ball screw spline unit

Introduction



CAUTION

Always read the specific instructions if the robot has protection type Clean Room, before doing any repair work, see [Cut the paint or surface on the robot before replacing parts on page 118](#)

Location of ball screw spline unit

The ball screw spline unit is located as shown in the figure.

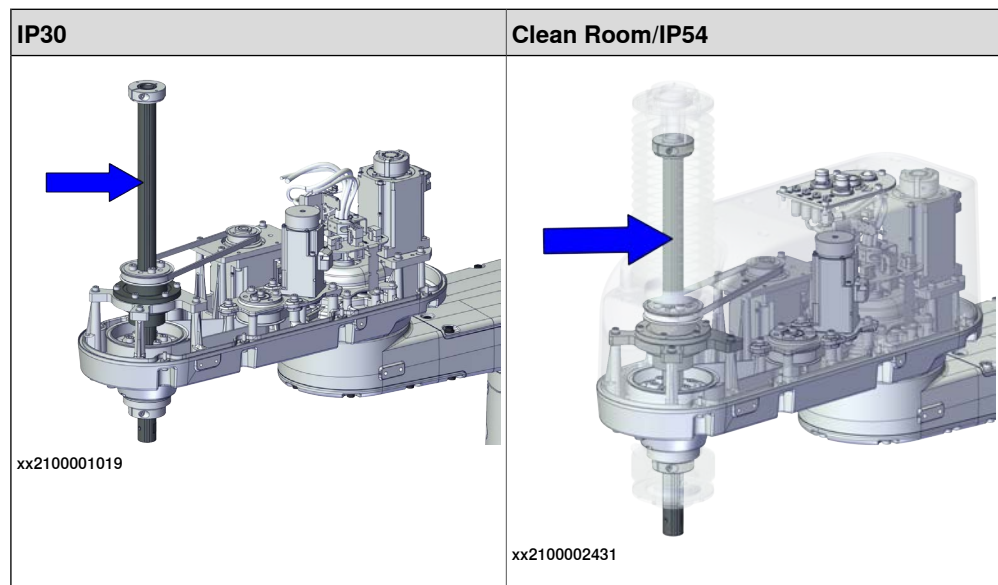

CAUTION

For the robots with protection type Clean Room and protection class IP54, the ball screw spline unit is inside the bellows. If needed, remove the bellows to inspect the ball screw spline unit.

For details about how to remove the bellows, see [Replacing the bellows](#).

Required spare parts



Note

The spare part numbers that are listed in the table can be out of date. See the latest spare parts of the IRB 920 via myABB Business Portal, www.abb.com/myABB.

Spare part	Article number	Note
Ball screw, BNS2020A+395LC5	3HAC070477-001	Used for IRB 920T-6/0.45_0.18, IRB 920T-6/0.55_0.18 and IRB 920T-6/0.65_0.18

Continues on next page

Spare part	Article number	Note
Ball screw, BNS2020A+515LC5	3HAC072983-001	Used for IRB 920T-6/0.45_0.3, IRB 920T-6/0.55_0.3 and IRB 920T-6/0.65_0.3
Ball Screw Flange	3HAC070479-001	Used for IRB 920T-6/0.45_0.18, IRB 920T-6/0.55_0.18 and IRB 920T-6/0.65_0.18
Mechanical-Stop top, D20	3HAC073068-001	With bolt
Mechanical-Stop bottom, D20	3HAC073069-001	With bolt

Required tools and equipment

Spare part	Article number	Note
Standard toolkit	-	Content is defined in section Standard toolkit on page 996 .
24 VDC power supply	-	Used to release the motor brakes.

Inspecting, ball screw spline unit



Note

For robots with protection type Clean Room

For robots with protection class IP54

First remove the upper bellow and lower bellow according to [Replacing the bellows on page 421](#).

Then, use this procedure to inspect the ball screw spline unit.



	Action	Note
1	Turn on the electric power supply to the robot. If the robot is not connected to the controller, power must be supplied to the connector R1.MP according to the section Supplying power to connector R1.MP on page 64 .	
2	DANGER When releasing the holding brakes, the robot axes may move very quickly and sometimes in unexpected ways! Make sure the payload is disassembled or tooling is properly supported; otherwise, fast downward movements of axis 3 may cause severe hits.	

Continues on next page

4 Maintenance

4.4.3 Inspecting the ball screw spline unit

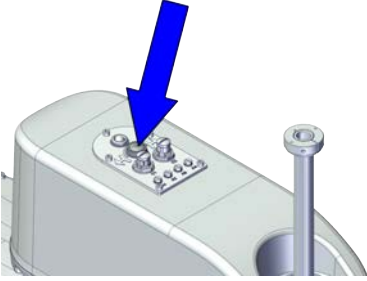
Continued

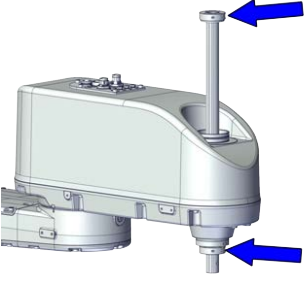
	Action	Note
3	Release the holding brake by pressing the button on the internal brake release unit.	 <p>xx2000001155</p>
4	Move the outer arm to a position where the axis 3 can be moved in full stroke.	
5	Press the brake release button and move the shaft to its upper and lower limits manually.	 <p>xx2000001155</p>
6	Visually inspect: <ul style="list-style-type: none"> • the stop blocks on the ball screw spline unit • the shaft of the ball screw spline unit Look for abrasions, cuts or crush damages on the spline, and grease amount on the shaft.	 <p>xx2000001158</p>
7	Apply grease to the shaft if it is not enough.	See Lubricating the ball screw spline unit on page 106 .
8	Replace the ball screw spline unit if wear or damage is detected.	See Replacing the ball screw on page 488 .

4.4.4 Inspecting axis-3 mechanical stops

Introduction



CAUTION

Always read the specific instructions if the robot has protection type Clean Room, before doing any repair work, see [Cut the paint or surface on the robot before replacing parts on page 118](#)

Location of axis-3 mechanical stops

The mechanical stops on axis 3 is located as shown in the figures.

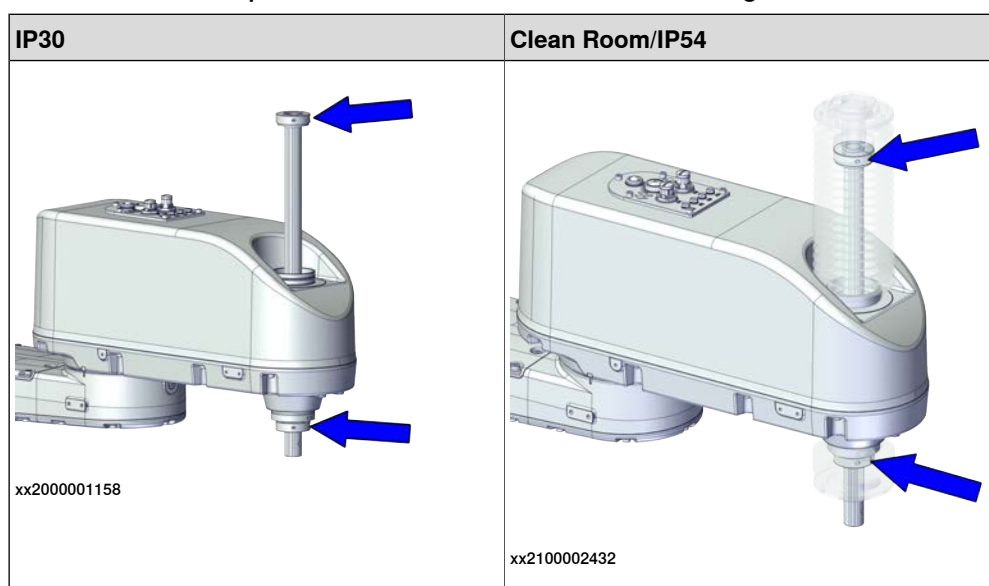

CAUTION

For the robots with protection type Clean Room and protection class IP54, the mechanical stops are inside the bellows. If needed, remove the bellows to inspect the ball screw spline unit.

For the details on removing the bellows, refer to [Replacing the bellows](#).

Required spare parts



Note

The spare part numbers that are listed in the table can be out of date. See the latest spare parts of the IRB 920 via myABB Business Portal, www.abb.com/myABB.

Spare part	Article number	Note
Mechanical-Stop top, D20	3HAC073068-001	With bolt
Mechanical-Stop bottom, D20	3HAC073069-001	With bolt

Continues on next page

4 Maintenance

4.4.4 Inspecting axis-3 mechanical stops

Continued

Required tools and equipment

Visual inspection, no tools are required.

Other tools and procedures may be required if the spare part needs to be replaced. These are specified in the replacement procedure.

Inspecting, axis-3 mechanical stops



Note



For robots with protection type Clean Room

For robots with protection class IP54



First remove the upper bellow and lower bellow according to [Replacing the bellows on page 421](#).

Then, use this procedure to inspect the ball screw spline unit.

Use this procedure to inspect mechanical stops on axes 1 and 2.

	Action	Information
1	 DANGER Turn off all: <ul style="list-style-type: none">• electric power supply• hydraulic pressure supply• air pressure supply to the robot, before entering the robot working area.	
2	 CAUTION For robots with protection type Clean Room Always cut the paint with a knife and grind the paint edge when disassembling parts of the robot! See Cut the paint or surface on the robot before replacing parts on page 118 .	

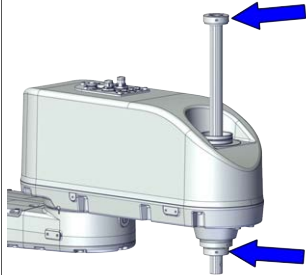
Continues on next page

	Action	Information
3	Inspect the mechanical stops.	 <p>xx2000001158</p>
4	Replace if any mechanical stop is: <ul style="list-style-type: none"> • bent • loose • damaged.  Note The expected life of gearboxes can be reduced as a result of collisions with the mechanical stop.	

4 Maintenance

4.4.5 Inspecting timing belts

4.4.5 Inspecting timing belts

Introduction



CAUTION

Always read the section "General procedures" before doing any repair work.

Cut the paint or surface on the robot before replacing parts on page 118.

Continues on next page

Location of timing belts

The timing belts are located as shown in the figures.

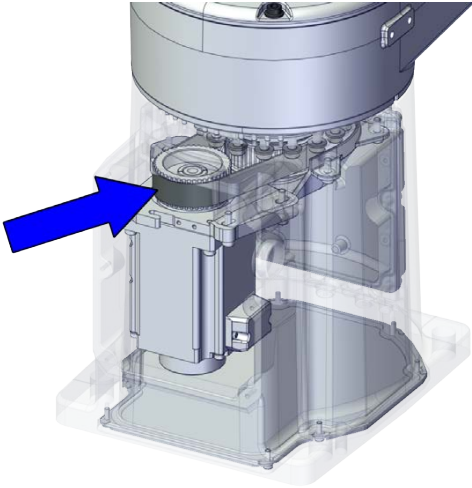
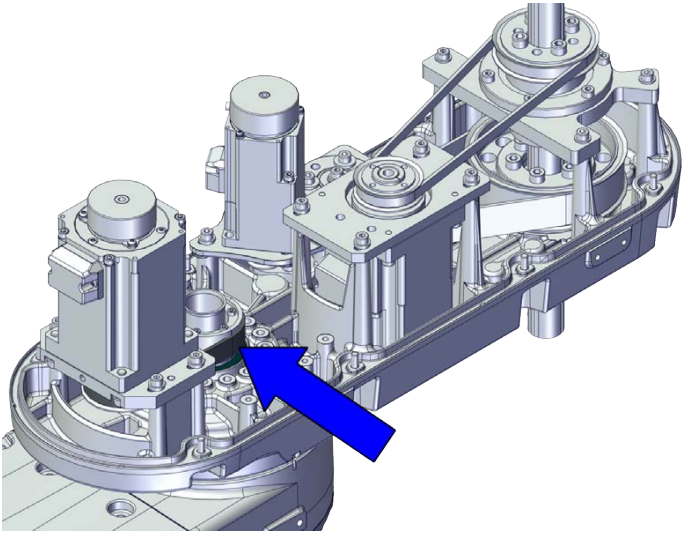
Axis	Location
1	 <p data-bbox="751 920 858 943">xx2100001015</p>
2	 <p data-bbox="751 1514 858 1536">xx2100001024</p>
3	

Continues on next page

4 Maintenance

4.4.5 Inspecting timing belts

Continued

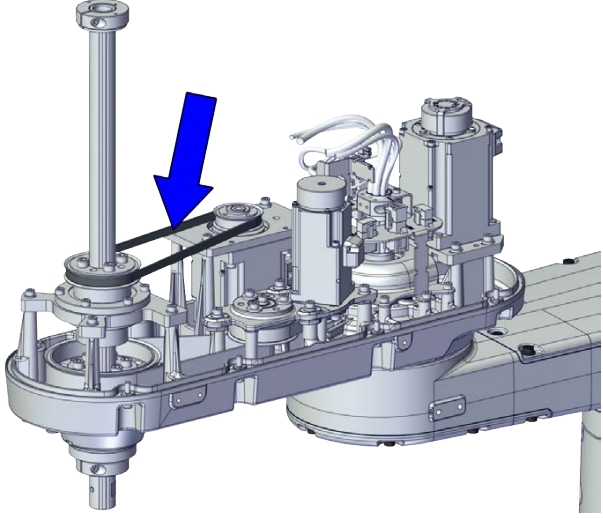
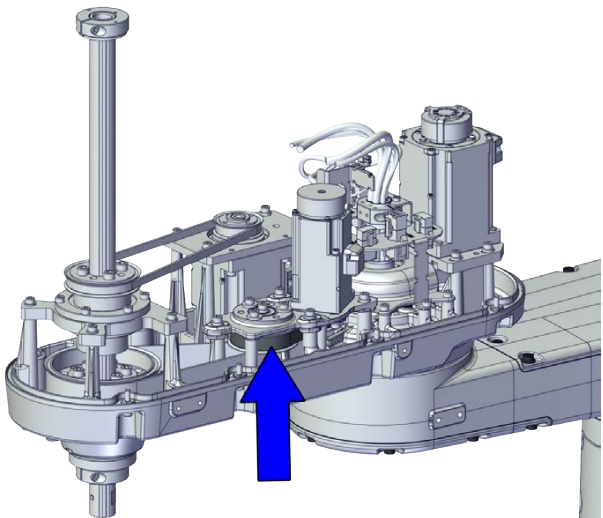
Axis	Location
	 <p>xx2100001020</p>
4	 <p>xx2100001022</p>
4-2	

Continues on next page

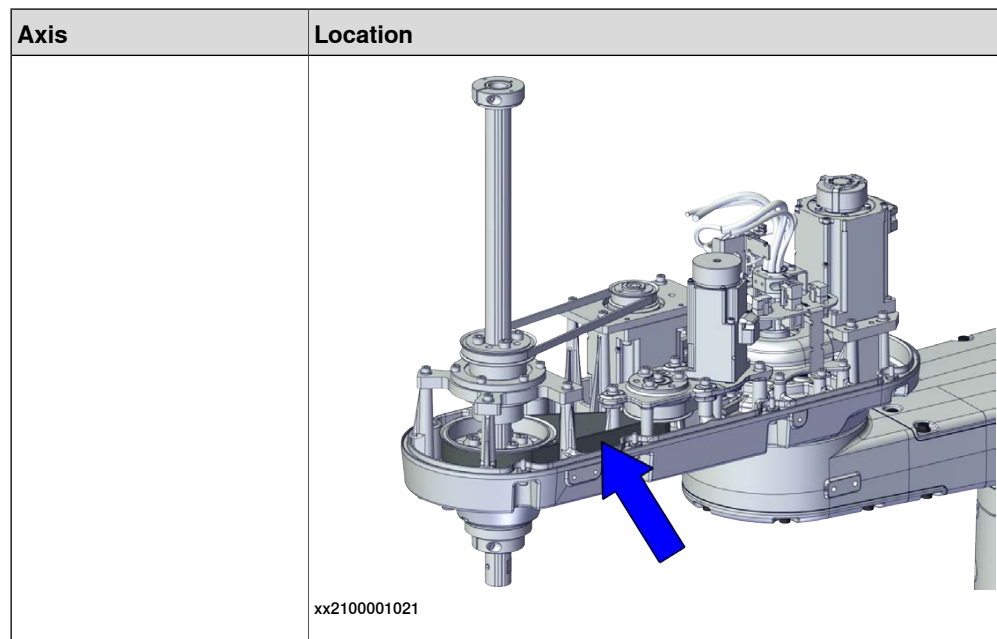

Required tools and equipment

Equipment	Note
Standard toolkit	The content is defined in the section Standard toolkit on page 996 .
Other tools and procedures may be required if the spare part needs to be replaced. These are specified in the replacement procedure.	

Timing belt tension

The table describes the timing belt tension.

Axis	Force		Frequency	
	Used timing belt	New timing belt	Used timing belt	New timing belt
Axis 1	51.1	90	308	250
Axis 2	64.7	70	315	260
Axis 3	36.6	40	139	110
Axis 4	36.3	35	312	245
Axis 4-2	100	240	202	180

Continues on next page

4 Maintenance

4.4.5 Inspecting timing belts

Continued

Inspecting timing belts

Use this procedure to inspect timing belts.

	Action	Information
1	 DANGER Turn off all: <ul style="list-style-type: none">• electric power supply• hydraulic pressure supply• air pressure supply to the robot, before entering the robot working area.	
2	Gain access to each <i>timing belt</i> by removing the cover.	
3	Check the timing belts for damage or wear.	
4	Check the <i>timing belt pulleys</i> for damage.	
5	If any damage or wear is detected, the part must be replaced!	
6	Use a sonic tension meter to measure the timing belt tension. Adjust the belt tension if needed!	See Timing belt tension on page 103 .

4.5 Replacement/changing activities

Replacing the battery pack

Replacing the battery pack is accessible after removing the SMB from the base, see [Replacing the SMB unit and battery unit on page 193](#).

4 Maintenance

4.6.1 Lubricating the ball screw spline unit

4.6 Lubrication activities

4.6.1 Lubricating the ball screw spline unit

Location of the ball screw spline unit

The ball screw spline unit is located as shown in the figure.

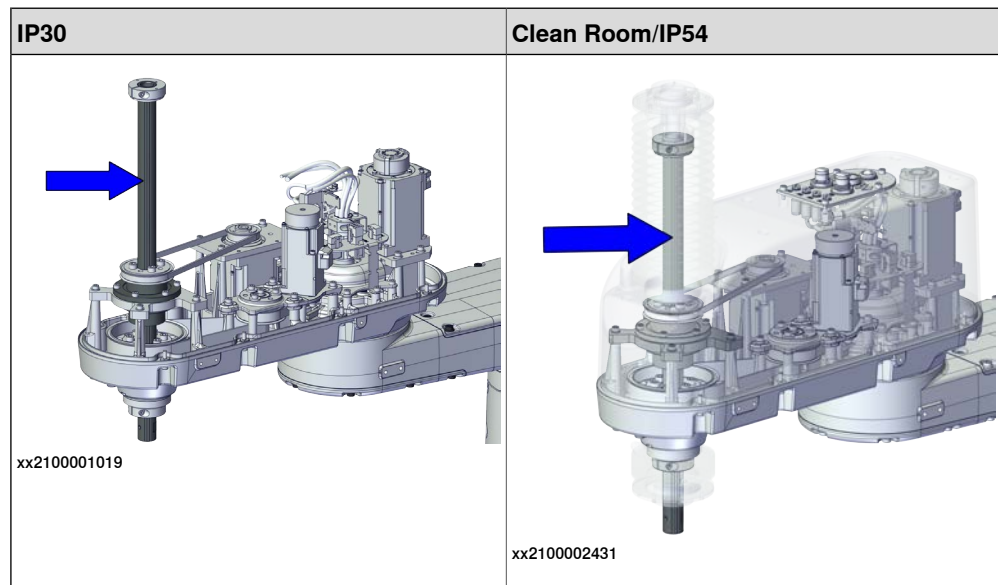

CAUTION

For the robots with protection type Clean Room and protection class IP54, the ball screw spline unit is inside the bellows. If needed, remove the bellows to inspect the ball screw spline unit.

For details about how to remove the bellows, see [Replacing the bellows](#).

Required tools and equipment

Equipment	Article number	Note
24 VDC power supply	-	Used to release the motor brakes.

Required consumables

Consumable	Article number	Note
Grease	-	THK AFA

Continues on next page

Lubricating the ball screw spline unit

**Note**

For robots with protection type Clean Room

For robots with protection class IP54

First remove the upper bellow and lower bellow according to [Replacing the bellows on page 421](#).

Then, use this procedure to inspect the ball screw spline unit.

**Note**

Cover the end effector and peripheral equipment in case the grease drips, before lubricating the ball screw spline unit.

	Action	Note
1	Turn on the electric power supply to the robot. If the robot is not connected to the controller, power must be supplied to the connector R1.MP according to the section Supplying power to connector R1.MP on page 64 .	
2	 DANGER When releasing the holding brakes, the robot axes may move very quickly and sometimes in unexpected ways! Make sure the payload is disassembled or tooling is properly supported; otherwise, fast downward movements of axis 3 may cause severe hits.	
3	Release the holding brake by pressing the button on the internal brake release unit.	
4	Move the outer arm to a position where the axis 3 can be moved in full stroke.	
5	Move the shaft manually to its upper limit while pressing the brake release button.	
6	Wipe off old grease from the shaft.	
7	Apply new grease and fill the grooves. Wipe off excessive grease.	
8	Move the shaft manually to its lower limit while pressing the brake release button.	
9	Wipe off old grease from the shaft.	
10	Apply new grease and fill the grooves. Wipe off excessive grease.	
11	Move the shaft up and down several times while pressing the brake release button to smooth out the grease on the shaft. Wipe off excessive grease.	

4 Maintenance

4.7.1 Cleaning the IRB 920

4.7 Cleaning activities

4.7.1 Cleaning the IRB 920

General

To secure high uptime it is important that the IRB 920 is cleaned regularly. The frequency of cleaning depends on the environment in which the manipulator works. Different cleaning methods are allowed depending on the type of protection of the IRB 920.



Note

Always verify the protection type of the robot before cleaning.



WARNING

Turn off all electrical power supplies to the robot before starting the cleaning.

Special cleaning considerations

This section specifies some special considerations when cleaning the robot.

- Always use cleaning equipment as specified. Any other cleaning equipment may shorten the life of the robot.
 - Always check that all protective covers are fitted to the robot before cleaning.
 - Do not point the water jet at connectors, joints, sealings or gaskets.
 - Do not use compressed air to clean the robot.
 - Do not use solvents that are not approved by ABB to clean the robot.
 - Do not spray from a distance closer than 0.4 m.
 - Do not remove any covers or other protective devices before cleaning the robot.
-

Cleaning methods

This following table defines what cleaning methods are allowed for ABB manipulators depending on the protection type.

Protection type	Cleaning method			
	Vacuum cleaner	Wipe with cloth	Rinse with water	High pressure water or steam
Standard IP30	Yes	Yes. With light cleaning detergent.	No	No

Continues on next page

Protection type	Cleaning method			
	Vacuum cleaner	Wipe with cloth	Rinse with water	High pressure water or steam
IP54 (option)	Yes	Yes. With light cleaning detergent.	Yes. It's highly recommended to inspect the fans for contamination that could hinder the air supply at the regular cleaning, and then clean if necessary. No	No
Clean room	Yes	Yes. With light cleaning detergent. See Additional cleaning instructions for Clean Room robots on page 109 .	No	No

Wiping with cloth

Additional cleaning instructions for Clean Room robots

ABB robots with protection types *Clean Room* are designed to be cleaned at a low cleaning frequency, before entering the cleanroom environment, after robot commissioning or during cleanroom maintenance.

Wipe-down cleaning method is recommended. Robot surfaces shall be wiped with clean and low particle emission cleanroom cloth which is soaked in 70% ethanol

Use the following procedure to clean Clean Room robots:

- 1 Before cleaning, use the lint free cloth to remove dirt, debris or any other contaminant from the to-be cleaned surfaces.
 - Make sure no visible residues left.
 - Never apply hard forces on or rub against the robot surfaces to remove dirt or debris; otherwise, protective paint layers may be damaged.
- 2 Wet a clean cloth with the cleaning detergent and then wipe the robot painting surfaces.
 - Make sure no cleaning agents are sprayed onto robot surfaces or into the robot structure.
 - Wipe from the surface center to edge and always in the same direction.
- 3 Wait a few minutes for detergent volatilization.
 - Make sure no residue of cleaning agents left on the robot surfaces after wipe down cleaning.

Continues on next page

4 Maintenance

4.7.1 Cleaning the IRB 920

Continued

Cleaning with water and steam

Instructions for rinsing with water

ABB robots with protection types *Standard*, *Foundry Plus*, *Wash*, or *Foundry Prime* can be cleaned by rinsing with water (water cleaner).¹

The following list defines the prerequisites:

- Maximum water pressure at the nozzle: 700 kN/m² (7 bar)¹
- Fan jet nozzle should be used, min. 45° spread
- Minimum distance from nozzle to encapsulation: 0.4 meters
- Maximum flow: 20 liters/min¹

¹ Typical tap water pressure and flow

Cables

Movable cables need to be able to move freely:

- Remove waste material, such as sand, dust and chips, if it prevents cable movement.
- Clean the cables if they have a crusty surface, for example from dry release agents.

¹ See [Cleaning methods on page 108](#) for exceptions.

5 Repair

5.1 Introduction

Structure of this chapter

This chapter describes repair activities for the IRB 920. Each procedure contains the information required to perform the activity, for example spare parts numbers, required special tools, and materials.



WARNING

Repair activities not described in this chapter must only be carried out by ABB.

Report replaced units



Note

When replacing a part on the IRB 920, report to your local ABB the serial number, the article number, and the revision of both the replaced unit and the replacement unit.

This is particularly important for safety equipment to maintain the safety integrity of the installation.

Safety information

Make sure to read through the chapter [Safety on page 15](#) before commencing any service work.



Note

The robot should be secured with the transportation brackets during removing from/refitting to the foundation.



Note

If the IRB 920 is connected to power, always make sure that the IRB 920 is connected to protective earth and a residual current device (RCD) before starting any repair work.

For more information see:

- *Product manual - OmniCore C30*
- *Product manual - OmniCore C90XT*
- *Product manual - OmniCore E10*

5 Repair

5.2.1 Performing a leak-down test

5.2 General procedures

5.2.1 Performing a leak-down test

When to perform a leak-down test

After refitting any motor and gearbox, the integrity of all seals enclosing the gearbox oil must be tested. This is done in a leak-down test.

Required equipment

Equipment, etc.	Article number	Note
Leak-down tester	-	
Leak detection spray	-	

Performing a leak-down test

	Action	Note
1	Finish the refitting procedure of the motor or gear in question.	
2	Remove the upper oil plug on the gear and replace it with the leak-down tester. Regulators, which are included in the leak-down test, may be required.	
3	Use caution, apply compressed air and raise the pressure with the knob until the correct value is shown on the manometer.  CAUTION The pressure must under no circumstance be higher than 0.25 bar (20-25 kPa). Also during the time when the pressure is raised.	Correct value: 0.2-0.25 bar (20-25 kPa)
4	Disconnect the compressed air supply.	
5	Wait for approximately 8-10 minutes and make sure that no pressure loss occurs.	If the compressed air is significantly colder or warmer than the gearbox to be tested, a slight pressure increase or decrease may occur. This is quite normal.
6	If any pressure drop occurred, then localize the leak as described in step 7. If no pressure drop occurred, then remove the leak-down tester and refit the oil plug. The test is complete.	
7	Spray any suspected leak areas with the leak detection spray. Bubbles indicate a leak.	
8	When the leak has been localized, take the necessary measures to correct the leak.	

5.2.2 Mounting instructions for bearings

General

This section describes how to mount and grease different types of bearings on the robot.

Equipment

Equipment, etc.	Article number	Note
Grease	3HAC042536-001	Shell Gadus S2 Used to grease the bearings, if not specified otherwise.

Assembly of all bearings

Attend to the following instructions while mounting a bearing on the robot.

	Action	Note
1	To avoid contamination, let a new bearing remain in its wrapping until it is time for fitting.	
2	Ensure that the parts included in the bearing fitting are free from burrs, grinding waste, and other contamination. Cast components must be free of foundry sand.	
3	Bearing rings, inner rings, and roller elements must not be subjected to direct impact. The roller elements must not be exposed to any stresses during the assembly work.	

Assembly of tapered bearings

Follow the preceding instructions for the assembly of the bearings when mounting a tapered bearing on the robot.

In addition to those instructions, the following procedure must be carried out to enable the roller elements to adjust to the correct position against the race flange.

	Action	Note
1	Tension the bearing gradually until the recommended pre-tension is achieved.  Note The roller elements must be rotated a specified number of turns before pre-tensioning is carried out and also rotated during the pre-tensioning sequence.	
2	Make sure the bearing is properly aligned as this will directly affect the durability of the bearing.	

Greasing of bearings



Note

This instruction is not valid for solid oil bearings.

Continues on next page

The bearings must be greased after assembly according to the following instructions:

- The bearings must not be completely filled with grease. However, if space is available beside the bearing fitting, the bearing may be totally filled with grease when mounted, as excessive grease will be pressed out from the bearing when the robot is started.
- During operation, the bearing should be filled to 70-80% of the available volume.
- Ensure that grease is handled and stored properly to avoid contamination.

Grease the different types of bearings as following description:

- *Grooved ball bearings* must be filled with grease from both sides.
- *Tapered roller bearings* and axial needle bearings must be greased in the split condition.

5.2.3 Mounting instructions for sealings

General

This section describes how to mount different types of sealings.

Equipment

Consumable	Article number	Note
Grease	3HAC042536-001	Shell Gadus S2

Rotating sealings

The procedure below describes how to fit rotating sealings.



CAUTION

Please observe the following before commencing any assembly of sealings:

- Protect the sealing during transport and mounting, especially the main lip.
- Keep the sealing in its original wrappings or protect it well before actual mounting.
- The fitting of sealings and gears must be carried out on clean workbenches.
- Use a protective sleeve for the main lip during mounting, when sliding over threads, keyways or other sharp edges.

Action	Note
1 Check the sealing to ensure that: <ul style="list-style-type: none"> • The sealing is of the correct type. • There is no damage on the main lip. 	
2 Inspect the shaft surface before mounting. If scratches or damage are found, the shaft must be replaced since it may result in future leakage. Do not try to grind or polish the shaft surface to get rid of the defect.	
3 Lubricate the sealing with grease just before fitting. (Not too early - there is a risk of dirt and foreign particles adhering to the sealing.) Fill 2/3 of the space between the dust lip and the main lip with grease. If the sealing is without dust lip, just lubricate the main lip with a thin layer of grease.	<p>Article number is specified in Equipment on page 115.</p> <p>xx2000000071</p> <p>A Main lip B Grease C Dust lip</p>

Continues on next page

5 Repair

5.2.3 Mounting instructions for sealings

Continued

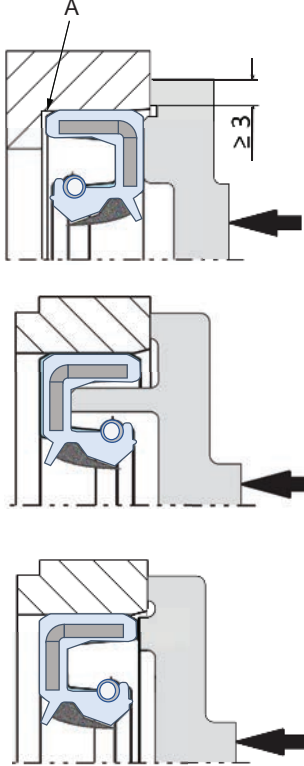
	Action	Note
4	<p>Mount the sealing correctly with a mounting tool. Never hammer directly on the sealing as this may result in leakage.</p>	 <p>xx2000000072</p> <p>A Gap</p>
5	<p>Make sure that no grease is left on the robot surface.</p>	

Flange sealings and static sealings

The following procedure describes how to fit flange sealings and static sealings.

	Action
1	<p>Check the flange surfaces. They must be even and free from pores. It is easy to check flatness using a gauge on the fastened joint (without sealing compound). If the flange surfaces are defective, the parts may not be used because leakage could occur.</p>
2	<p>Clean the surfaces properly in accordance with the recommendations of ABB.</p>
3	<p>Distribute the sealing compound evenly over the surface, preferably with a brush.</p>
4	<p>Tighten the screws evenly when fastening the flange joint.</p>

O-rings

The following procedure describes how to fit o-rings.

	Action	Note
1	<p>Ensure that the correct o-ring size is used.</p>	
2	<p>Check the o-ring for surface defects, burrs, shape accuracy, or deformation.</p>	<p>Defective o-rings, including damaged or deformed o-rings, may not be used.</p>

Continues on next page

	Action	Note
3	Check the o-ring grooves. The grooves must be geometrically correct and should be free of pores and contamination.	
4	Lubricate the o-ring with grease.	
5	Tighten the screws evenly while assembling.	
6	Check that the o-ring is not squashed outside the o-ring groove.	
7	Make sure that no grease is left on the robot surface.	

5 Repair

5.2.4 Cut the paint or surface on the robot before replacing parts

5.2.4 Cut the paint or surface on the robot before replacing parts

General

Follow the procedures in this section whenever breaking the paint of the robot during replacement of parts.

For robots with protection type Clean Room

When replacing parts on the robot, it is important to make sure that after the replacement, no particles will be emitted from the joint between the structure and the new part, and that the easy cleaned surface is retained.

Required equipment

Equipment	Spare parts	Note
Sealing compound	3HAC026759-001	Sikaflex 521 FC. Color white.
Tooling pin		Width 6-9 mm, made of wood.
Cleaning agent		Ethanol
Knife		
Lint free cloth		
Touch up paint Clean Room/Hygienic	3HAC036639-001	White
Touch up paint Standard/Foundry Plus	3HAC067974-001	Graphite White

Removing

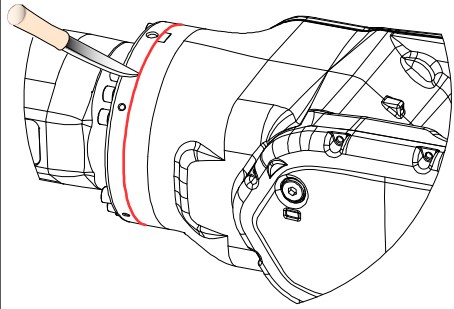
Action	Description
1 Cut the paint with a knife in the joint between the part that will be removed and the structure, to avoid that the paint cracks.	 xx0900000121
2 Carefully grind the paint edge that is left on the structure to a smooth surface.	



Refitting

Action	Description
1 Before the parts are refitted, clean the joint so that it is free from oil and grease.	Use ethanol on a lint free cloth.
2 Place the tooling pin in hot water.	

Continues on next page

5.2.4 Cut the paint or surface on the robot before replacing parts

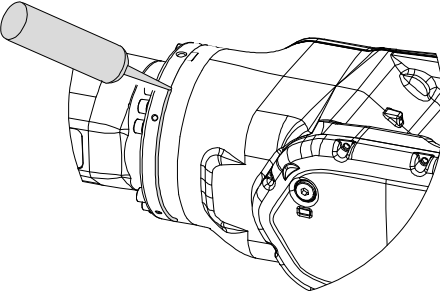
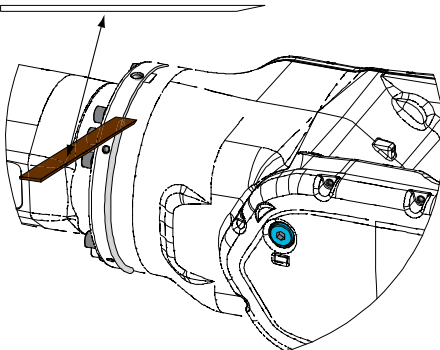
Continued

	Action	Description
3	Seal all refitted joints with sealing compound.	 <p>xx0900000122</p>
4	Use the tooling pin to even out the surface of the sealing compound.	 <p>xx0900000125</p>
5	For robots with protection type Clean Room Wait 10 minutes.	For robots with protection type Clean Room Sikaflex 521FC skin dry time (10 minutes).
6	Use Touch up paint Clean Room/Hygienic, white to paint any damaged surfaces.  Note Always read the instruction in the product data sheet in the paint repair kit for Clean Room/Hygienic.	3HAC036639-001

**Note**

After all repair work, wipe the robot free from particles with spirit on a lint free cloth.

5 Repair

5.3.1 Replacing the main harness

5.3 Cable harness

5.3.1 Replacing the main harness

Location of the main harness

The main harness is located as shown in the figure.

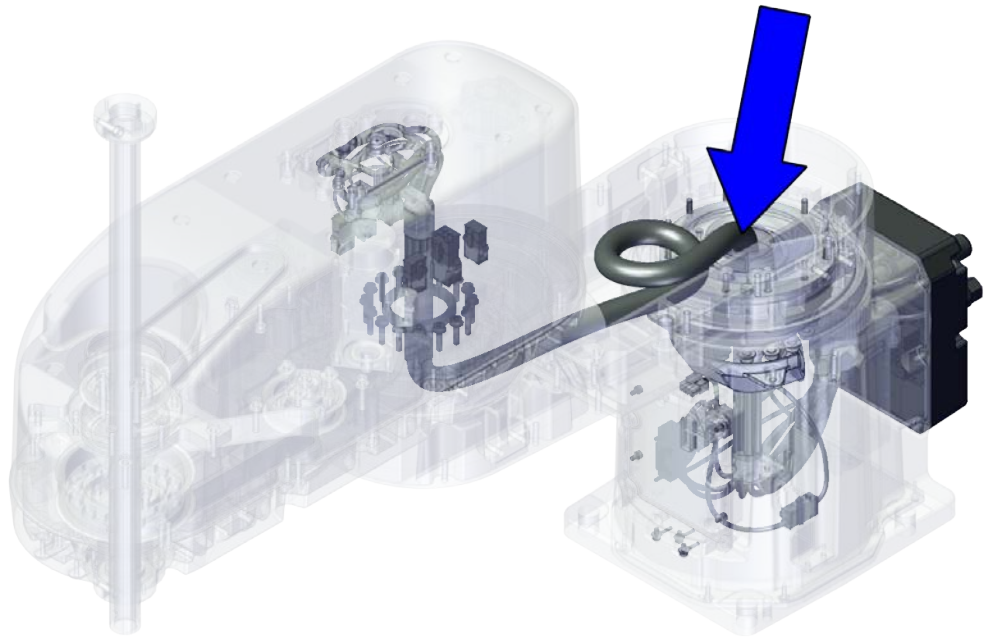

xx2100001029

Required spare parts



Note

The spare part numbers that are listed in the table can be out of date. See the latest spare parts of the IRB 920 via myABB Business Portal, www.abb.com/myABB.

Spare part	Article number	Note
Main harness MS, Basic	3HAC076580-001	
Main harness MS, Basic+C1+Air	3HAC076581-001	
Main harness MS, Basic+C1+C2+Air	3HAC076582-001	
Main harness ML, Basic	3HAC079759-001	
Main harness ML, Basic+C1+Air	3HAC079760-001	
Main harness ML, Basic+C1+C2+Air	3HAC079761-001	
Base plate, rear outlet cable	3HAC067865-001	Base bottom cover, rear cable

Continues on next page

Spare part	Article number	Note
Rear plate	3HAC070312-001	Base rear cover, bottom cable
Base plate, undeneath outlet cable	3HAC067864-001	Base bottom cover, bottom cable
Gasket, Foot cover	3HAC065350-001	When using with UndeneathOutletCable, this gasket will be used in rear plate and base plate.
One-way valve	3HAC044906-001	Used with protection type Clean Room.

Required tools and equipment

Equipment	Article number	Note
Standard toolkit	-	Content is defined in section Standard toolkit on page 996 .
Calibration toolbox, Axis Calibration	3HAC055412-001	Delivered as a set of calibration tools. Required if Axis Calibration is the valid calibration method for the robot.

Required consumables

Consumable	Article number	Note
Cable straps	-	
Grease	3HAC029132-001	FM 222

Deciding calibration routine

Decide which calibration routine to be used, based on the information in the table. Depending on which routine is chosen, action might be required prior to beginning the repair work of the robot, see the table.

	Action	Note
1	<p>Decide which calibration routine to use for calibrating the robot.</p> <ul style="list-style-type: none"> Reference calibration. External cable packages (DressPack) and tools can stay fitted on the robot. Fine calibration. All external cable packages (DressPack) and tools must be removed from the robot. 	
	<p>If the robot is to be calibrated with reference calibration:</p> <p>Find previous reference values for the axis or create new reference values. These values are to be used after the repair procedure is completed, for calibration of the robot.</p> <p>If no previous reference values exist, and no new reference values can be created, then reference calibration is not possible.</p>	<p>Follow the instructions given in the reference calibration routine on the FlexPendant to create reference values.</p> <p>Creating new values requires possibility to move the robot.</p> <p>Read more about reference calibration for Axis Calibration in Reference calibration routine on page 957.</p>

Continues on next page

5 Repair

5.3.1 Replacing the main harness



Continued

Action	Note
<p>If the robot is to be calibrated with fine calibration: Remove all external cable packages (DressPack) and tools from the robot.</p>	

Removing the main harness



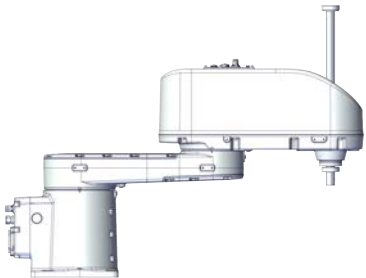

Use these procedures to remove the main harness.

Preparations before removing the main arm

Action	Note
1	Decide which calibration routine to use, and take actions accordingly prior to beginning the repair procedure.
2	<p>If there is no enough space for the maintenance work, remove the robot from the wall and place it on the maintenance bracket.</p> <p> CAUTION</p> <p>Do not lay down the robot during the transportation, always keep it straight. If the robot lay down in any situation, the grease may come out from gearbox.</p>
3	<p>Jog all axes to zero position.</p>  <p>xx210000930</p>
4	<p> DANGER</p> <p>Turn off all:</p> <ul style="list-style-type: none"> • electric power supply • hydraulic pressure supply • air pressure supply <p>to the robot, before entering the safeguarded space.</p>
5	<p> CAUTION</p> <p>For robots with protection type Clean Room Always cut the paint with a knife and grind the paint edge when disassembling parts of the robot! See Cut the paint or surface on the robot before replacing parts on page 118.</p>

Continues on next page

Removing the process hub screws

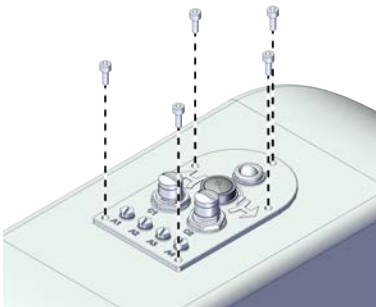
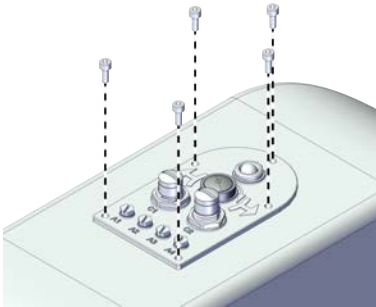
	Action	Note
1	 <p>DANGER</p> <p>Make sure that all supplies for electrical power, hydraulic pressure, and air pressure are turned off.</p>	
2	 <p>CAUTION</p> <p>For robots with protection type Clean Room Always cut the paint with a knife and grind the paint edge when disassembling parts of the robot! See Cut the paint or surface on the robot before replacing parts on page 118.</p>	
3	<p>Remove the screws on the process hub.</p>  <p>Note</p> <p>For robots with protection class IP54 (option 3350-540) For robots with protection type Clean Room (option 3351-1) Remove the screws on the process hub and take out the gasket.</p>  <p>Tip</p> <p>Check the gasket and replace it if needed.</p>	<p>For robots with protection class IP30</p>  <p>xx210000932</p> <p>For robots with protection class IP54 (option 3350-540) For robots with protection type Clean Room (option 3351-1)</p>  <p>xx210000932</p>
4	<p>Insert the process hub to the outer arm.</p>	

Continues on next page





5 Repair

5.3.1 Replacing the main harness

Continued

For Clean Room/ IP54 robots

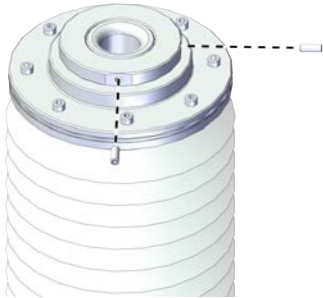

Removing the top cover and the flange with bearing

	Action	Note
1	 DANGER Make sure that all supplies for electrical power, hydraulic pressure, and air pressure are turned off.	
2	 CAUTION For robots with protection type Clean Room Always cut the paint with a knife and grind the paint edge when disassembling parts of the robot! See Cut the paint or surface on the robot before replacing parts on page 118 .	
3	For robots with protection class IP54 (option 3350-540) For robots with protection type Clean Room (option 3351-1) Loose the locking screws.	 xx2100002398
4	For robots with protection class IP54 (option 3350-540) For robots with protection type Clean Room (option 3351-1) Remove the top cover from the ball screw.	 xx2100002399

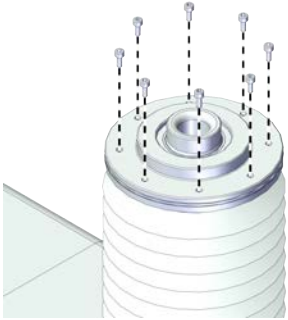
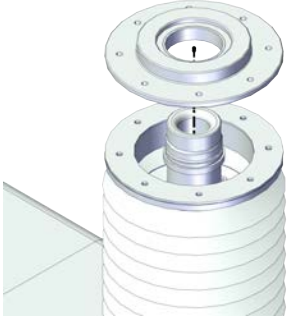
Continues on next page

	Action	Note
5	<p>For robots with protection class IP54 (option 3350-540) For robots with protection type Clean Room (option 3351-1) Remove the screws on the flange with bearing.</p>	 <p>xx2100002401</p>
6	<p>For robots with protection class IP54 (option 3350-540) For robots with protection type Clean Room (option 3351-1) Remove the flange with bearing.</p>	 <p>xx2100002402</p>

Removing the cover of the outer arm



	Action	Note
1	<p> DANGER</p> <p>Make sure that all supplies for electrical power, hydraulic pressure, and air pressure are turned off.</p>	
2	<p> CAUTION</p> <p>For robots with protection type Clean Room Always cut the paint with a knife and grind the paint edge when disassembling parts of the robot! See Cut the paint or surface on the robot before replacing parts on page 118.</p>	

Continues on next page



5 Repair

5.3.1 Replacing the main harness

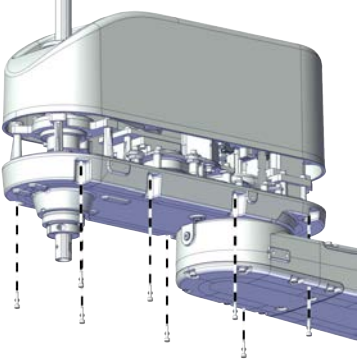
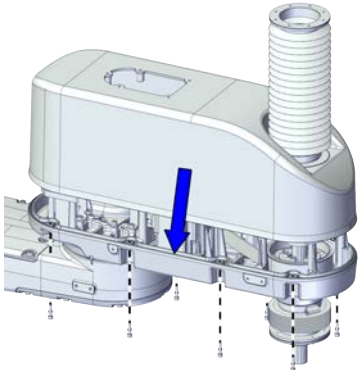



Continued

	Action	Note
3	<p>Remove the screws on the cover of the outer arm and remove the cover.</p> <p> Note</p> <p>For robots with protection class IP54 (option 3350-540) For robots with protection type Clean Room (option 3351-1) Remove the cover with bellow and housing.</p> <p> Note</p> <p>The bellow does not need to be removed separately.</p> <p> Tip</p> <p>Check the gasket and replace it if needed.</p>	<p>For robots with protection class IP30</p>  <p>xx210000933</p> <p>For robots with protection class IP54 (option 3350-540) For robots with protection type Clean Room (option 3351-1)</p>  <p>xx2100002427</p>

Disconnecting the air hoses, C1 cabling and C2 cabling (if equipped)

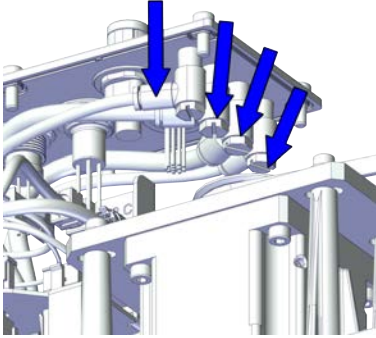
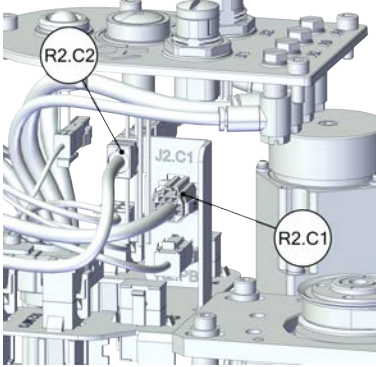
	Action	Note
1	<p> DANGER</p> <p>Make sure that all supplies for electrical power, hydraulic pressure, and air pressure are turned off.</p>	
2	<p> CAUTION</p> <p>For robots with protection type Clean Room Always cut the paint with a knife and grind the paint edge when disassembling parts of the robot! See Cut the paint or surface on the robot before replacing parts on page 118.</p>	

Continues on next page

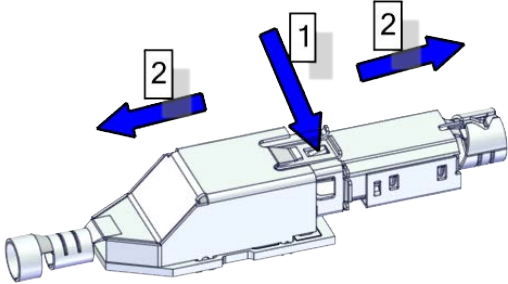
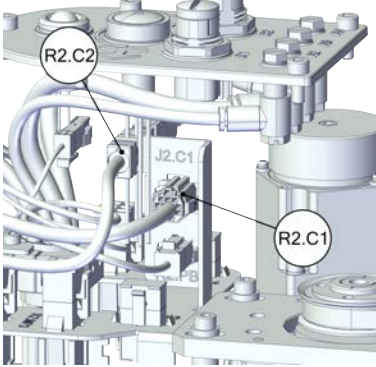
	Action	Note
3	<p>Disconnect the air hoses from the L-shaped connectors.</p>	 <p>xx2100001032</p>
4	<p>For robots with C1 cabling Disconnect the connector.</p> <ul style="list-style-type: none"> • R2.C1 	 <p>xx2100001033</p>
5	<p>For robots with C2 cabling Disconnect the connector.</p> <ul style="list-style-type: none"> • R1.C2 <p> Tip</p> <p>Cut the cable straps for the R1.C2 at the same time.</p> <p> Tip</p> <p>Take photos of the connector and cable position before disconnecting them, to have as a reference when reconnecting.</p> <p> Tip</p> <p>The connector clip has to be pressed (1) and pushed forward (2) to separate the R1.C2 (for C2 cabling).</p>  <p>xx1800002943</p>	 <p>xx2100001033</p>



5 Repair

5.3.1 Replacing the main harness

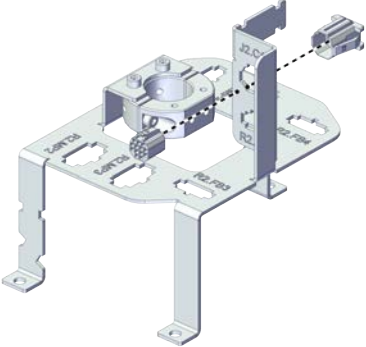
Continued

	Action	Note
6	<p>Snap loose and remove the female head of the connectors from the bracket.</p> <p> Note</p> <p>The harness are not visible due to the cleanness requirements of the illustration. They are still existing inside the cable ferrule in the actual situation.</p>	 <p>xx2100001034</p>

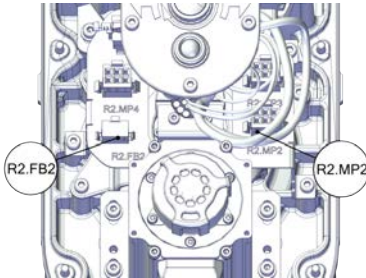

Disconnecting the connectors for axis-2 motor

	Action	Note
1	<p> DANGER</p> <p>Make sure that all supplies for electrical power, hydraulic pressure, and air pressure are turned off.</p>	
2	<p> CAUTION</p> <p>For robots with protection type Clean Room Always cut the paint with a knife and grind the paint edge when disassembling parts of the robot! See Cut the paint or surface on the robot before replacing parts on page 118.</p>	
3	<p>Disconnect the connectors.</p> <ul style="list-style-type: none"> • R2.MP2 • R2.FB2 	 <p>xx2100000934</p>

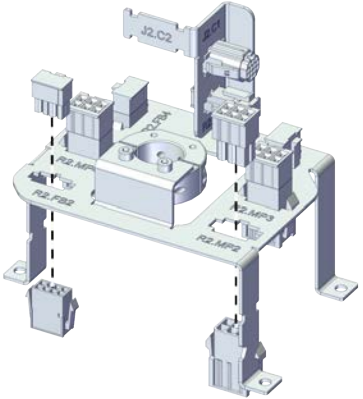
Continues on next page

	Action	Note
4	<p>Snap loose and remove the female head of the connectors from the bracket.</p> <p> Note</p> <p>The harness are not visible due to the cleanness requirements of the illustration. They are still existing inside the cable ferrule in the actual situation.</p>	 <p>xx2100000935</p>

Disconnecting the connectors for axis-3 motor

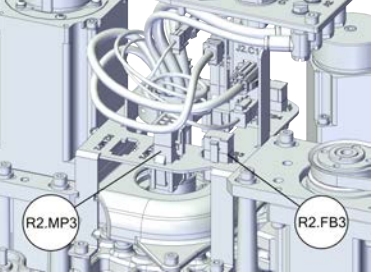
	Action	Note
1	<p> DANGER</p> <p>Make sure that all supplies for electrical power, hydraulic pressure, and air pressure are turned off.</p>	
2	<p> CAUTION</p> <p>For robots with protection type Clean Room</p> <p>Always cut the paint with a knife and grind the paint edge when disassembling parts of the robot! See Cut the paint or surface on the robot before replacing parts on page 118.</p>	
3	<p>Disconnect the connectors.</p> <ul style="list-style-type: none"> • R2.MP3 • R2.FB3 	 <p>xx2100000936</p>



5 Repair

5.3.1 Replacing the main harness

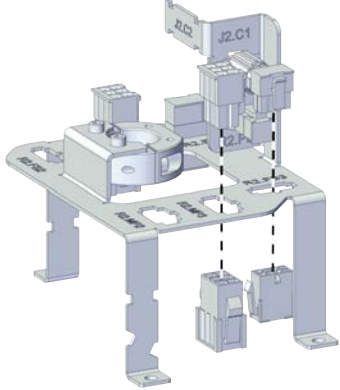
Continued



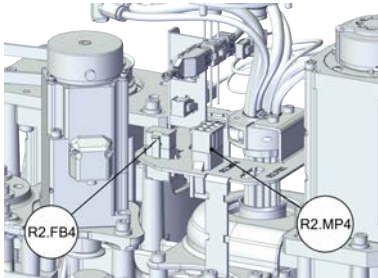

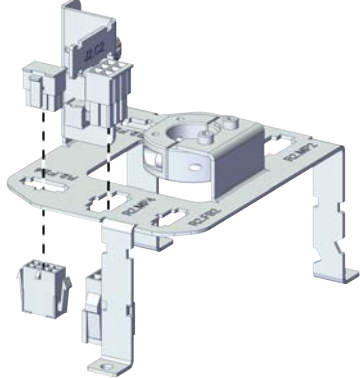
	Action	Note
4	<p>Snap loose and remove the female head of the connectors from the bracket.</p> <p> Note</p> <p>The harness are not visible due to the cleanness requirements of the illustration. They are still existing inside the cable ferrule in the actual situation.</p>	 <p>xx210000937</p>

Disconnecting the connectors for axis-4 motor

	Action	Note
1	<p>For robots with protection type Clean Room: Clean the joints that have been opened and wipe the parts free from particles with spirit on a lint free. See Cut the paint or surface on the robot before replacing parts on page 118</p> <p> Note</p> <p>After all repair work, wipe the Clean Room robot free from particles with spirit on a lint free cloth.</p>	
2	<p>Disconnect the axis-4 motor connectors.</p> <ul style="list-style-type: none"> • R2.MP4 • R2.FB4 	 <p>xx210000938</p>
3	<p>Snap loose and remove the female head of the connectors from the bracket.</p> <p> Note</p> <p>The harness are not visible due to the cleanness requirements of the illustration. They are still existing inside the cable ferrule in the actual situation.</p>	 <p>xx210000939</p>

Continues on next page

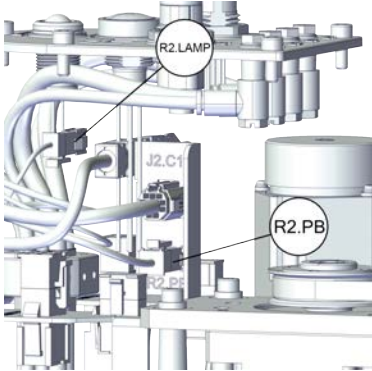
Disconnecting the connector for PB

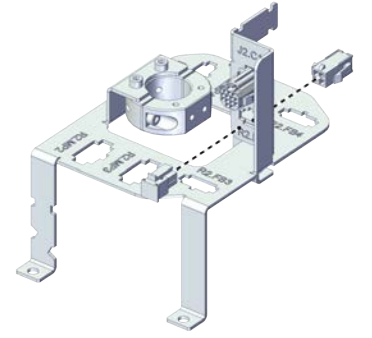
	Action	Note
1	 DANGER Make sure that all supplies for electrical power, hydraulic pressure, and air pressure are turned off.	
2	 CAUTION For robots with protection type Clean Room Always cut the paint with a knife and grind the paint edge when disassembling parts of the robot! See Cut the paint or surface on the robot before replacing parts on page 118 .	
3	Disconnect the connector. <ul style="list-style-type: none"> • R2.PB • R2.LAMP 	 <p>xx2100001030</p>
4	Snap loose and remove the female head of the connector from the bracket.  Note The harness are not visible due to the cleanliness requirements of the illustration. They are still existing inside the cable ferrule in the actual situation.	 <p>xx2100001031</p>

Pull out the process hub





	Action	Note
1	 DANGER Make sure that all supplies for electrical power, hydraulic pressure, and air pressure are turned off.	

Continues on next page



5 Repair

5.3.1 Replacing the main harness

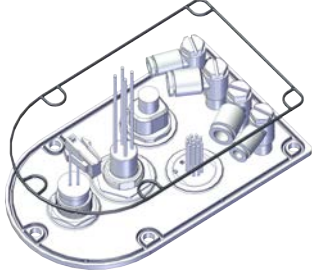

Continued

	Action	Note
2	 CAUTION For robots with protection type Clean Room Always cut the paint with a knife and grind the paint edge when disassembling parts of the robot! See Cut the paint or surface on the robot before replacing parts on page 118 .	
3	Take out the process hub.  Note For robots with protection class IP54 (option 3350-540) For robots with protection type Clean Room (option 3351-1) Check the gasket for the process hub.  Tip Replace the gasket if needed.  CAUTION Be aware of the cabling that is attached to the cover! The cover can not be removed completely until the connectors are disconnected, as shown in following steps.	For robots with protection class IP54 (option 3350-540) For robots with protection type Clean Room (option 3351-1)  xx2100002438

Removing the cable ferrule and bracket

	Action	Note
1	 DANGER Make sure that all supplies for electrical power, hydraulic pressure, and air pressure are turned off.	
2	 CAUTION For robots with protection type Clean Room Always cut the paint with a knife and grind the paint edge when disassembling parts of the robot! See Cut the paint or surface on the robot before replacing parts on page 118 .	

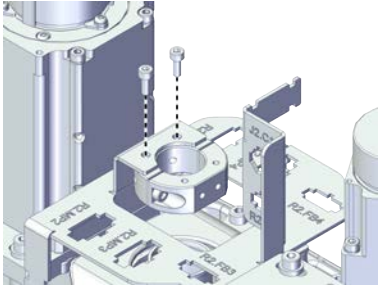
Continues on next page

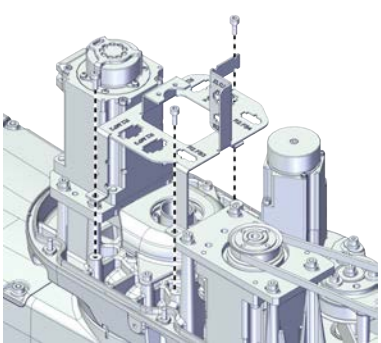
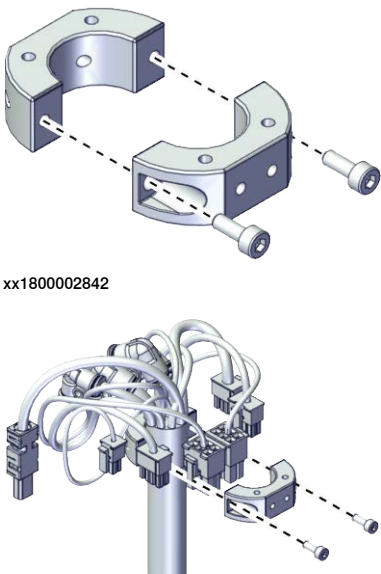
	Action	Note
3	<p>Remove the screws on the bracket to the cable ferrule to release the cable ferrule with cable.</p> <p> Note</p> <p>The harness are not visible due to the cleanness requirements of the illustration. They are still existing inside the cable ferrule in the actual situation.</p>	 <p>xx2100000940</p>
4	<p>Remove the screws on the bracket.</p> <p> Note</p> <p>The harness are not visible due to the cleanness requirements of the illustration. They are still existing inside the cable ferrule in the actual situation.</p>	 <p>xx2100000941</p>
5	<p>Remove the screws on the cable ferrule and take the cable ferrule out.</p>	 <p>xx1800002842</p> <p>xx1800002849</p>

Removing the axis-1 cover



	Action	Note
1	<p> DANGER</p> <p>Make sure that all supplies for electrical power, hydraulic pressure, and air pressure are turned off.</p>	

Continues on next page



5 Repair

5.3.1 Replacing the main harness

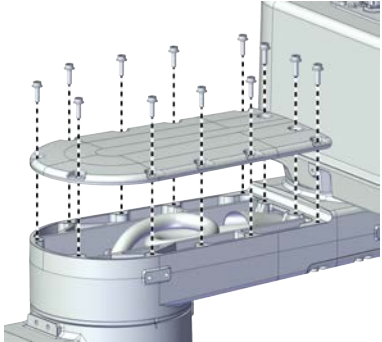
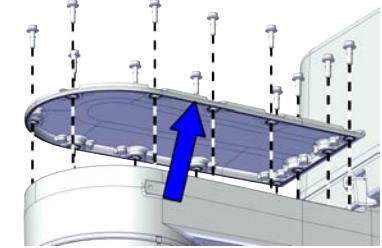

Continued

	Action	Note
2	 CAUTION For robots with protection type Clean Room Always cut the paint with a knife and grind the paint edge when disassembling parts of the robot! See Cut the paint or surface on the robot before replacing parts on page 118 .	
3	Remove the screws.	For robots with protection class IP30 (option 3350-300)
4	Remove the cover.  Note For robots with protection class IP54 (option 3350-540) For robots with protection type Clean Room (option 3351-1) Remove the cover and check the gasket.  Tip Replace the gasket if needed.	 <p>xx2100000942</p> <p>For robots with protection class IP54 (option 3350-540) For robots with protection type Clean Room (option 3351-1)</p>  <p>xx2100002428</p>



Removing the axis-2 cover

	Action	Note
1	 DANGER Make sure that all supplies for electrical power, hydraulic pressure, and air pressure are turned off.	
2	 CAUTION For robots with protection type Clean Room Always cut the paint with a knife and grind the paint edge when disassembling parts of the robot! See Cut the paint or surface on the robot before replacing parts on page 118 .	

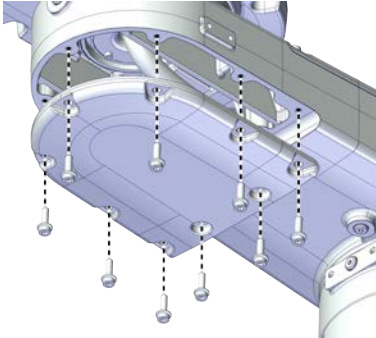
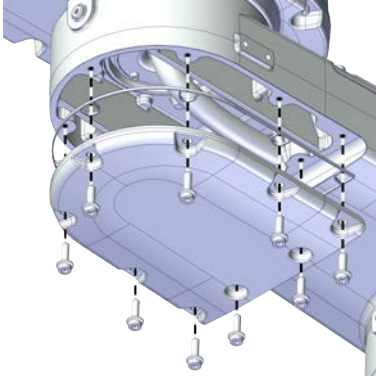
Continues on next page

	Action	Note
3	Remove the screws.	
4	<p>Remove the cover.</p> <p> Note</p> <p>For robots with protection class IP54 (option 3350-540)</p> <p>For robots with protection type Clean Room (option 3351-1)</p> <p>Remove the cover and check the gasket.</p> <p> Tip</p> <p>Replace the gasket if needed.</p>	<p>For robots with protection class IP30 (option 3350-300)</p>  <p>xx2100000943</p> <p>For robots with protection class IP54 (option 3350-540)</p> <p>For robots with protection type Clean Room (option 3351-1)</p>  <p>xx2100002451</p>

Removing the SMB cover





	Action	Note
1	<p> DANGER</p> <p>Make sure that all supplies for electrical power, hydraulic pressure, and air pressure are turned off.</p>	
2	<p> ELECTROSTATIC DISCHARGE (ESD)</p> <p>The unit is sensitive to ESD. Before handling the unit read the safety information in section The unit is sensitive to ESD on page 49.</p>	

Continues on next page

5 Repair

5.3.1 Replacing the main harness

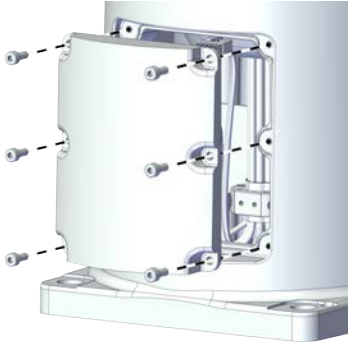

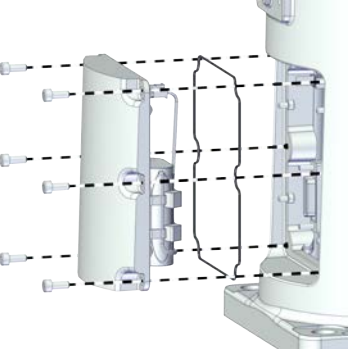
Continued

	Action	Note
3	 CAUTION For robots with protection type Clean Room Always cut the paint with a knife and grind the paint edge when disassembling parts of the robot! See Cut the paint or surface on the robot before replacing parts on page 118 .	
4	Remove the screws on the SMB cover to the base.  Note For robots with protection type Clean Room (option 3351-1) Remove the stainless screws on the SMB cover to the base.	For robots with protection class IP30 (option 3350-300) 
5	Pull the SMB cover with the SMB unit assembly out together.  Note For robots with protection class IP54 (option 3350-540) For robots with protection type Clean Room (option 3351-1) Check the gasket for the SMB cover.  Tip Replace the gasket if needed.	xx210000944 For robots with protection class IP54 (option 3350-540) For robots with protection type Clean Room (option 3351-1)  xx2100002433



Disconnecting the SMB cabling

	Action	Note
1	 DANGER Make sure that all supplies for electrical power, hydraulic pressure, and air pressure are turned off.	

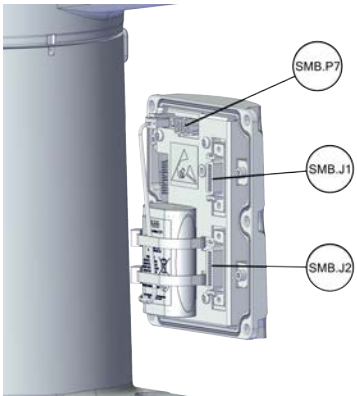
Continues on next page

	Action	Note
2	 ELECTROSTATIC DISCHARGE (ESD) The unit is sensitive to ESD. Before handling the unit read the safety information in section The unit is sensitive to ESD on page 49 .	
3	 CAUTION For robots with protection type Clean Room Always cut the paint with a knife and grind the paint edge when disassembling parts of the robot! See Cut the paint or surface on the robot before replacing parts on page 118 .	
4	Cut the strips.	
5	Disconnect the connectors. <ul style="list-style-type: none"> • SMB.P7 • SMB.J1 • SMB.J2  Tip Take photos of the connector and cable position before disconnecting them, to have as a reference when reconnecting.	 <p>xx2100000945</p>

Removing the base plate/ rear plate



	Action	Note
1	 DANGER Make sure that all supplies for electrical power, hydraulic pressure, and air pressure are turned off.	
2	 CAUTION For robots with protection type Clean Room Always cut the paint with a knife and grind the paint edge when disassembling parts of the robot! See Cut the paint or surface on the robot before replacing parts on page 118 .	
3	Remove the screws on the base to the ground.	
4	Lay down the robot.	

Continues on next page



5 Repair

5.3.1 Replacing the main harness

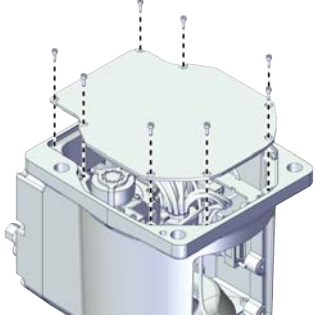
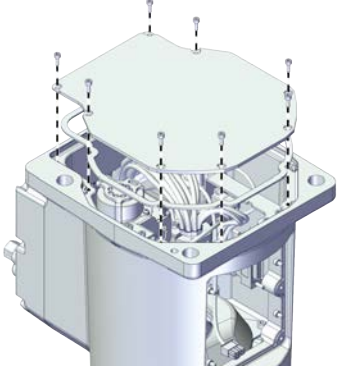

Continued

	Action	Note
5	For robot with rear outlet cable version, remove the screws on the base plate.	For rear outlet cable version:
6	<p>Remove the base plate.</p> <p> Note</p> <p>For robots with protection class IP54 (option 3350-540)</p> <p>For robots with protection type Clean Room (option 3351-1)</p> <p>Check the gasket for the base plate.</p> <p> Tip</p> <p>Replace the gasket if needed.</p>	<p>For robots with protection class IP30 (option 3350-300)</p>  <p>xx210000946</p> <p>For robots with protection class IP54 (option 3350-540)</p> <p>For robots with protection type Clean Room (option 3351-1)</p>  <p>xx2100002434</p>

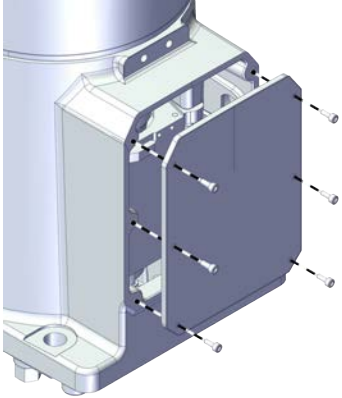
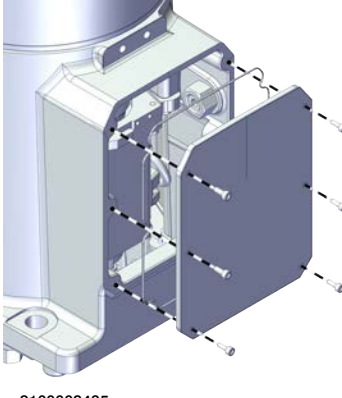
Continues on next page

	Action	Note
7	For robot with underneath outlet cable version, remove the screws on the rear plate.	For underneath outlet cable version:
8	<p>Remove the rear plate.</p> <p> Note</p> <p>For robots with protection class IP54 (option 3350-540)</p> <p>For robots with protection type Clean Room (option 3351-1)</p> <p>Check the gasket for the rear plate.</p> <p> Tip</p> <p>Replace the gasket if needed.</p>	<p>For robots with protection class IP30 (option 3350-300)</p>  <p>xx2100001202</p> <p>For robots with protection class IP54 (option 3350-540)</p> <p>For robots with protection type Clean Room (option 3351-1)</p>  <p>xx2100002435</p>

Disconnecting the grounding cable connectors

	Action	Note
1	<p> DANGER</p> <p>Make sure that all supplies for electrical power, hydraulic pressure, and air pressure are turned off.</p>	
2	<p> CAUTION</p> <p>For robots with protection type Clean Room</p> <p>Always cut the paint with a knife and grind the paint edge when disassembling parts of the robot!</p> <p>See Cut the paint or surface on the robot before replacing parts on page 118.</p>	

Continues on next page



5 Repair

5.3.1 Replacing the main harness

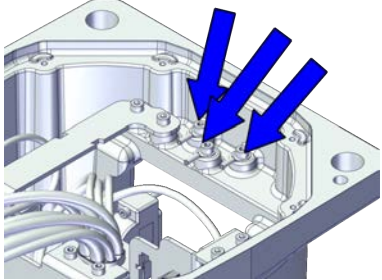
Continued

	Action	Note
3	Remove the three grounding cables from the bracket by unscrew the screws.	 xx2100000947

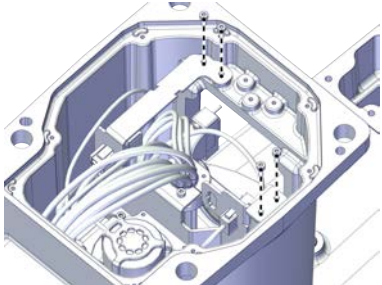

Releasing the base bracket

	Action	Note
1	 DANGER Make sure that all supplies for electrical power, hydraulic pressure, and air pressure are turned off.	
2	 CAUTION For robots with protection type Clean Room Always cut the paint with a knife and grind the paint edge when disassembling parts of the robot! See Cut the paint or surface on the robot before replacing parts on page 118 .	
3	Remove the screws on the base bracket to the base.	 xx2100000948

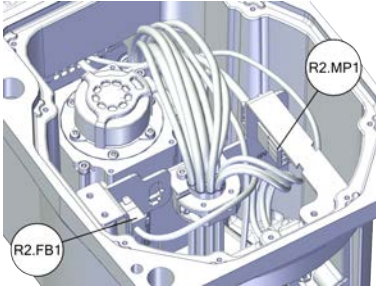

Disconnecting the connectors for axis-1 motor

	Action	Note
1	 DANGER Make sure that all supplies for electrical power, hydraulic pressure, and air pressure are turned off.	

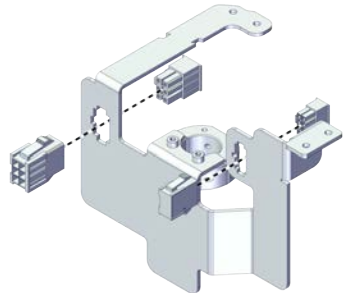
Continues on next page

	Action	Note
2	<p> CAUTION</p> <p>For robots with protection type Clean Room Always cut the paint with a knife and grind the paint edge when disassembling parts of the robot! See <i>Cut the paint or surface on the robot before replacing parts on page 118.</i></p>	
3	<p>Disconnect the connectors.</p> <ul style="list-style-type: none"> • R2.MP1 • R2.FB1 	 <p>xx210000949</p>
4	<p>Snap loose and remove the female head of the connectors from the bracket.</p> <p> Note</p> <p>The harness are not visible due to the cleanness requirements of the illustration. They are still existing inside the cable ferrule in the actual situation.</p>	 <p>xx210000950</p>

Removing the bracket

	Action	Note
1	<p> DANGER</p> <p>Make sure that all supplies for electrical power, hydraulic pressure, and air pressure are turned off.</p>	
2	<p> CAUTION</p> <p>For robots with protection type Clean Room Always cut the paint with a knife and grind the paint edge when disassembling parts of the robot! See <i>Cut the paint or surface on the robot before replacing parts on page 118.</i></p>	

Continues on next page



5 Repair

5.3.1 Replacing the main harness

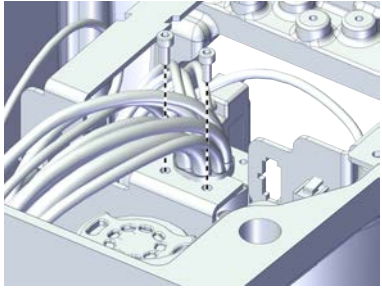
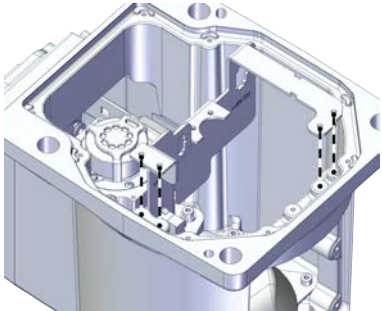

Continued

	Action	Note
3	Release the cable ferrule from the bracket.	 xx2100000951
4	Remove the bracket.	 xx2100000952



Removing the main harness from the axis -2 gearbox position

	Action	Note
1	 DANGER Make sure that all supplies for electrical power, hydraulic pressure, and air pressure are turned off.	
2	 CAUTION For robots with protection type Clean Room Always cut the paint with a knife and grind the paint edge when disassembling parts of the robot! See Cut the paint or surface on the robot before replacing parts on page 118 .	

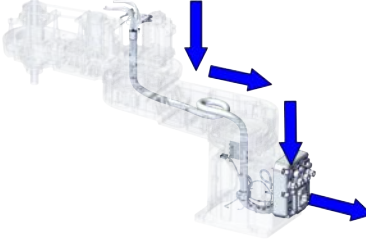
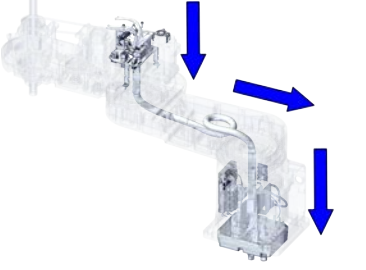
Continues on next page

	Action	Note
3	<p>Pull the internal harness out of the outer arm from the centre of the axis-2 gearbox.</p> <p> Tip Wrap the connectors with the masking tape.</p> <p> Tip Take photos of the connector and cable position before disconnecting them, to have as a reference when reconnecting.</p>	<p>For rear outlet cable version:</p>  <p>xx2100000954</p> <p>For underneath outlet cable version:</p>  <p>xx2100001203</p>

Removing the main harness from the axis -1 gearbox position

	Action	Note
1	<p> DANGER</p> <p>Make sure that all supplies for electrical power, hydraulic pressure, and air pressure are turned off.</p>	
2	<p> CAUTION</p> <p>For robots with protection type Clean Room Always cut the paint with a knife and grind the paint edge when disassembling parts of the robot! See Cut the paint or surface on the robot before replacing parts on page 118.</p>	

Continues on next page



5 Repair

5.3.1 Replacing the main harness

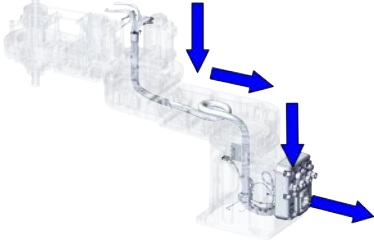
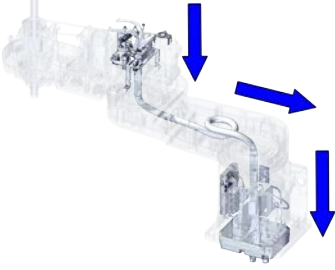

Continued

	Action	Note
3	<p>Pull the internal harness out of the inner arm from the sleeve of the axis-1 gearbox.</p> <p> Tip</p> <p>Wrap the connectors with the masking tape.</p>	<p>For rear outlet cable version:</p>  <p>xx2100000954</p> <p>For underneath outlet cable version:</p>  <p>xx2100001203</p>

Removing the main harness

	Action	Note
1	<p> DANGER</p> <p>Make sure that all supplies for electrical power, hydraulic pressure, and air pressure are turned off.</p>	
2	<p> CAUTION</p> <p>For robots with protection type Clean Room</p> <p>Always cut the paint with a knife and grind the paint edge when disassembling parts of the robot!</p> <p>See Cut the paint or surface on the robot before replacing parts on page 118.</p>	

Continues on next page

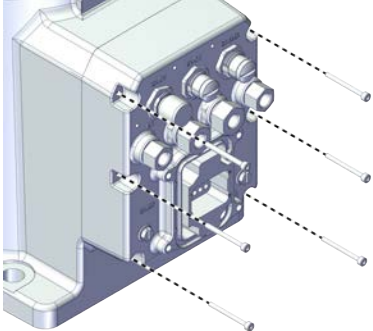
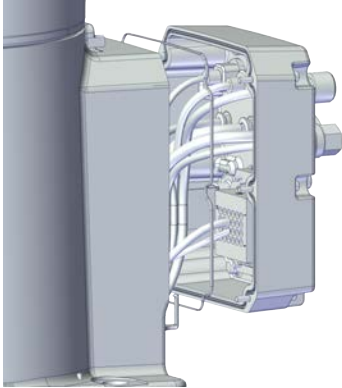

	Action	Note
3	For robot with rear outlet cable version, remove the screws on the main harness to the base.	For rear outlet cable version:
4	<p>Remove the main harness.</p> <p> Note</p> <p>For robots with protection class IP54 (option 3350-540)</p> <p>For robots with protection type Clean Room (option 3351-1)</p> <p>Check the gasket for the main harness.</p> <p> Tip</p> <p>Replace the gasket if needed.</p>	<p>For robots with protection class IP30 (option 3350-300)</p>  <p>xx2100000953</p> <p>For robots with protection class IP54 (option 3350-540)</p> <p>For robots with protection type Clean Room (option 3351-1)</p>  <p>xx2100002436</p>

Continues on next page

5 Repair

5.3.1 Replacing the main harness

Continued

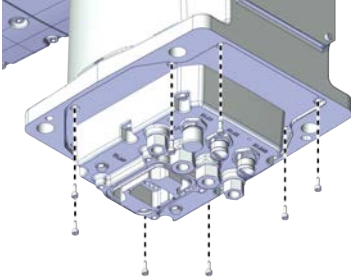
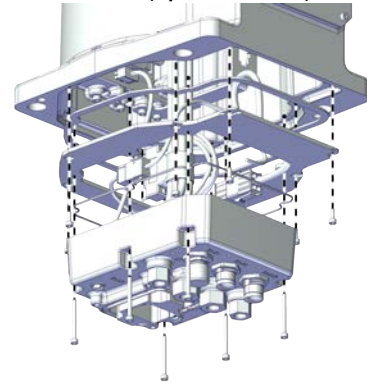
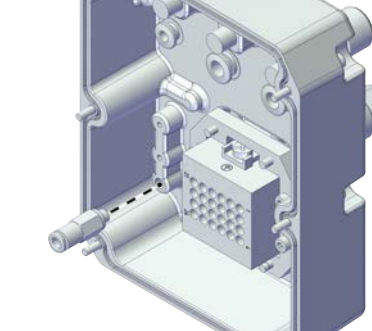



	Action	Note
5	For robot with underneath outlet cable version, remove the screws on the main harness assembly.	For underneath outlet cable version:
6	<p>Remove the main harness assembly.</p> <p> Note</p> <p>For robots with protection class IP54 (option 3350-540)</p> <p>For robots with protection type Clean Room (option 3351-1)</p> <p>Check the gasket for the main harness assembly.</p> <p> Tip</p> <p>Replace the gasket if needed.</p> <p> Note</p> <p>Remove the bottom plate from the main harness if needed.</p>	<p>For robots with protection class IP30 (option 3350-300)</p>  <p>xx2100001204</p> <p>For robots with protection class IP54 (option 3350-540)</p> <p>For robots with protection type Clean Room (option 3351-1)</p>  <p>xx2100002437</p>
7	<p>For robots with protection type Clean Room (option 3351-1)</p> <p>Remove the one way valve by unscrewing it.</p>	 <p>xx2200000281</p>

Continues on next page

Refitting the main harness

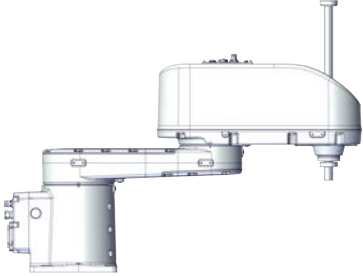
Use these procedures to refit the main harness.

Inserting the main harness through the axis -1 gearbox position

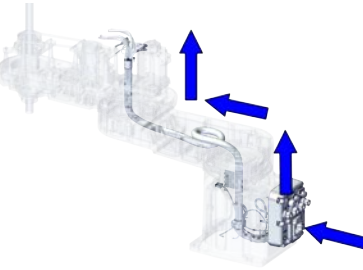
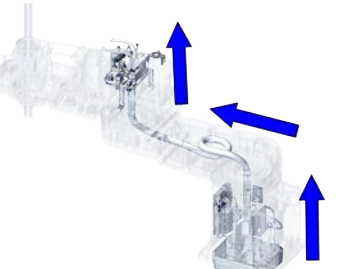
	Action	Note
1	<p>For robots with protection type Clean Room: Clean the joints that have been opened and wipe the parts free from particles with spirit on a lint free. See Cut the paint or surface on the robot before replacing parts on page 118</p> <p> Note</p> <p>After all repair work, wipe the Clean Room robot free from particles with spirit on a lint free cloth.</p>	
2	<p>Make sure that the robot is at zero position.</p>	 <p>xx2100000930</p>
3	<p>Insert the internal harness into the inner arm through the sleeve of the axis-1 gearbox from the base.</p> <p> Tip</p> <p>Wrap the connectors with the masking tape.</p> <p> Tip</p> <p>The air hoses should face the axis-1 motor.</p> <p> CAUTION</p> <p>Make sure that no cables or hoses are twisted or strained. Reroute if necessary.</p>	<p>For rear outlet cable version:</p>  <p>xx2100000955</p> <p>For underneath outlet cable version:</p>  <p>xx2100001206</p>



Continues on next page

5 Repair

5.3.1 Replacing the main harness

Continued



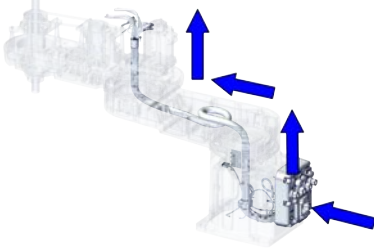
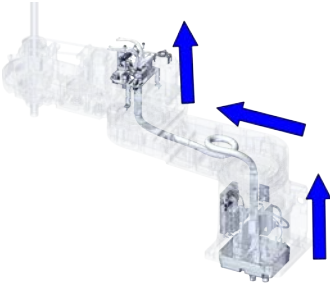



Inserting the main harness through the axis -2 gearbox position

	Action	Note
1	<p>For robots with protection type Clean Room: Clean the joints that have been opened and wipe the parts free from particles with spirit on a lint free. See Cut the paint or surface on the robot before replacing parts on page 118</p> <p> Note</p> <p>After all repair work, wipe the Clean Room robot free from particles with spirit on a lint free cloth.</p>	
2	<p>Insert the internal harness into the outer arm through the plastic protection tube and the centre of the axis-2 gearbox.</p> <p> Tip</p> <p>Wrap the connectors with the masking tape.</p>	<p>For rear outlet cable version:</p>  <p>xx2100000955</p> <p>For underneath outlet cable version:</p>  <p>xx2100001206</p>
3	Secure the R2.MP3 and R2.MP4 with cable straps.	

Reconnecting the connectors for axis-1 motor

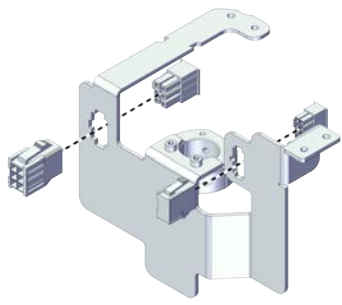
	Action	Note
1	<p>For robots with protection type Clean Room: Clean the joints that have been opened and wipe the parts free from particles with spirit on a lint free. See Cut the paint or surface on the robot before replacing parts on page 118</p> <p> Note</p> <p>After all repair work, wipe the Clean Room robot free from particles with spirit on a lint free cloth.</p>	

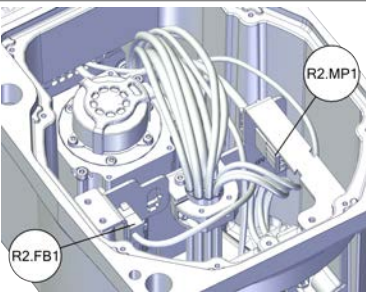
Continues on next page

	Action	Note
2	<p>Insert the female head of the connectors to the bracket accordingly.</p> <p> Tip</p> <p>The mistake proofing measure has been applied to the connectors, the connectors may be damaged if excessive force is used.</p> <p> Note</p> <p>The harness are not visible due to the cleanness requirements of the illustration. They are still existing inside the cable ferrule in the actual situation.</p>	 <p>xx2100000950</p>
3	<p>Reconnect the connectors.</p> <ul style="list-style-type: none"> • R2.MP1 • R2.FB1 <p> Tip</p> <p>See the number markings on the connectors for help to find the corresponding connector.</p>	 <p>xx2100000949</p>
4	<p>Route the cabling behind the axis-1 motor.</p> <p> CAUTION</p> <p>Correct cable routing is highly important. If the cables are routed and secured incorrectly the cables can be damaged.</p>	



Reconnecting the grounding cable connectors

	Action	Note
1	<p>For robots with protection type Clean Room: Clean the joints that have been opened and wipe the parts free from particles with spirit on a lint free. See Cut the paint or surface on the robot before replacing parts on page 118</p> <p> Note</p> <p>After all repair work, wipe the Clean Room robot free from particles with spirit on a lint free cloth.</p>	

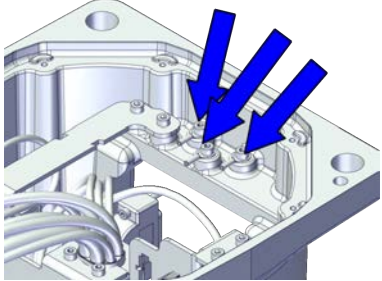

5 Repair

5.3.1 Replacing the main harness



Continued

	Action	Note
2	Secure the three grounding cables to the bracket with the screw.	<p>Screws: Hex socket head cap screw M3x5 12.9 Lafre 2C2B/FC6.9 (3 pcs) Tightening torque: 1.5 Nm \pm10%</p>  <p>xx2100000947</p>
3	<p>Route and secure the cabling with cable straps if needed.</p> <p> CAUTION</p> <p>Correct cable routing is highly important. If the cables are routed and secured incorrectly the cables can be damaged.</p>	

Refitting the base bracket

	Action	Note
1	<p> DANGER</p> <p>Make sure that all supplies for electrical power, hydraulic pressure, and air pressure are turned off.</p>	
2	<p> CAUTION</p> <p>For robots with protection type Clean Room Always cut the paint with a knife and grind the paint edge when disassembling parts of the robot! See Cut the paint or surface on the robot before replacing parts on page 118.</p>	
3	Lay the main harness in a natural state without distortion.	

Continues on next page

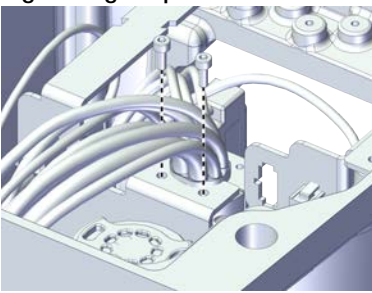
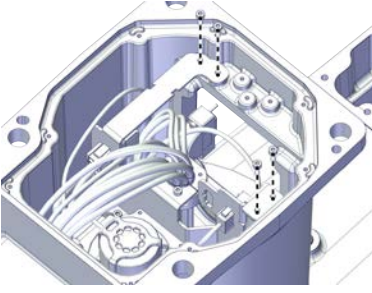
	Action	Note
	<p>Secure the cable ferrule to the bracket.</p> <p> Tip</p> <p>Align all the cable ferrules so that the cable is in a natural bending position to avoid twisting.</p> <p> Note</p> <p>The harness are not visible due to the cleanness requirements of the illustration. They are still existing inside the cable ferrule in the actual situation.</p>	<p>Screws: Hex socket head cap screw M3x8 12.9 Lafre 2C2B/FC6.9 (2 pcs)</p> <p>Tightening torque: 1.2 Nm \pm10%</p>  <p>xx2100000951</p>
4	<p>Refit the base bracket to the base and secure with the screws.</p>	<p>Screws: Hex socket head cap screw M3x8 12.9 Lafre 2C2B/FC6.9 (4 pcs)</p> <p>Tightening torque: 1.2 Nm \pm10%</p>  <p>xx2100000948</p>

Refitting the SMB cover

	Action	Note
1	<p>For robots with protection type Clean Room:</p> <p>Clean the joints that have been opened and wipe the parts free from particles with spirit on a lint free. See Cut the paint or surface on the robot before replacing parts on page 118</p> <p> Note</p> <p>After all repair work, wipe the Clean Room robot free from particles with spirit on a lint free cloth.</p>	

Continues on next page



5 Repair

5.3.1 Replacing the main harness

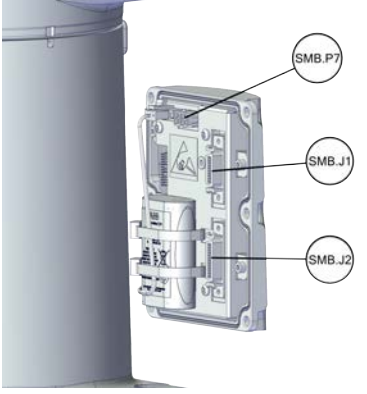
Continued

	Action	Note
2	<p>Reconnect the connectors.</p> <ul style="list-style-type: none">• SMB.P7• SMB.J1• SMB.J2 <p> Tip</p> <p>Take photos of the connector and cable position before disconnecting them, to have as a reference when reconnecting.</p>	 <p>xx2100000945</p>

Continues on next page

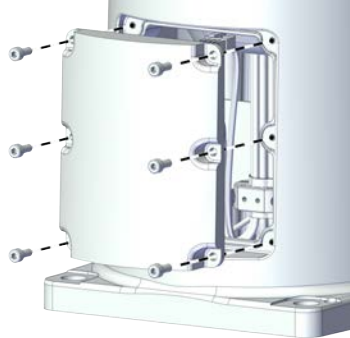
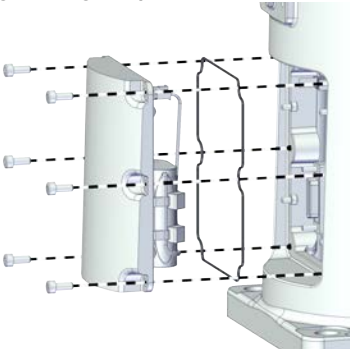
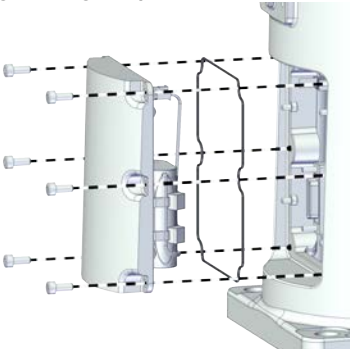
	Action	Note
3	<p>Refit the SMB cover assembly.</p> <p> Note</p> <p>For robots with protection class IP54 (option 3350-540)</p> <p>For robots with protection type Clean Room (option 3351-1)</p> <p>Check the gasket for the SMB cover.</p> <p> Tip</p> <p>Replace the gasket if needed.</p>	<p>For robots with protection class IP30 (option 3350-300)</p> <p>Screws: Hex socket head cap screw M4x10 12.9 Lafre 2C2B/FC6.9 (6 pcs)</p> <p>Tightening torque: 2.6 Nm</p> 
4	<p>Secure the SMB cover to the base with the screws.</p>	<p>xx210000944</p> <p>For robots with protection type Clean Room (option 3351-1)</p> <p>Screws: Stainless Screw Hexagon Socket Head Cap, Clean Room 3HAC075438-001 (6 pcs)</p> <p>Tightening torque: 2.6 Nm</p>  <p>xx2100002433</p> <p>For robots with protection class IP54 (option 3350-540)</p> <p>Screws: Hex socket head cap screw M4x10 12.9 Lafre 2C2B/FC6.9 (6 pcs)</p> <p>Tightening torque: 2.6 Nm</p>  <p>xx2100002433</p>

Continues on next page

5 Repair

5.3.1 Replacing the main harness

Continued

Refitting the main harness

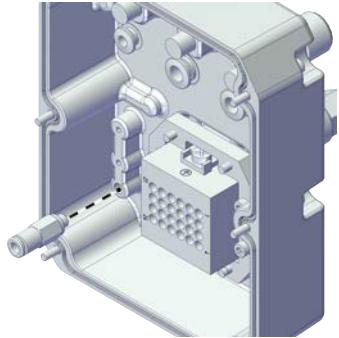
	Action	Note
1	<p>For robots with protection type Clean Room: Clean the joints that have been opened and wipe the parts free from particles with spirit on a lint free. See Cut the paint or surface on the robot before replacing parts on page 118</p> <p> Note</p> <p>After all repair work, wipe the Clean Room robot free from particles with spirit on a lint free cloth.</p>	
2	<p>For robots with protection type Clean Room (option 3351-1) Refit the one way valve by screwing it into the main harness assembly.</p>	 xx2200000281

Continues on next page

5.3.1 Replacing the main harness

Continued

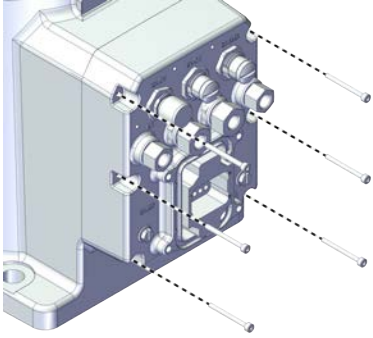
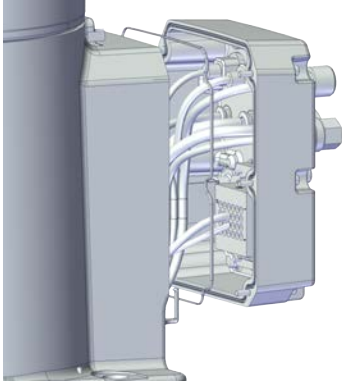
	Action	Note
3	For rear outlet cable version, refit the main harness to the base.	For rear outlet cable version:
4	Secure with the screws.	<p>For robots with protection class IP30 (option 3350-300)</p> <p>Screws: Hex socket head cap screw M3x30 12.9 Lafre 2C2B/FC6.9 (6 pcs)</p> <p>Tightening torque: 1.2 Nm ±10%</p>  <p>xx210000953</p> <p>For robots with protection class IP54 (option 3350-540)</p> <p>For robots with protection type Clean Room (option 3351-1)</p> <p>Screws: Hex socket head cap screw M3x30 12.9 Lafre 2C2B/FC6.9 (6 pcs)</p> <p>Tightening torque: 1.2 Nm ±10%</p>  <p>xx2100002436</p>

Continues on next page

5 Repair

5.3.1 Replacing the main harness

Continued

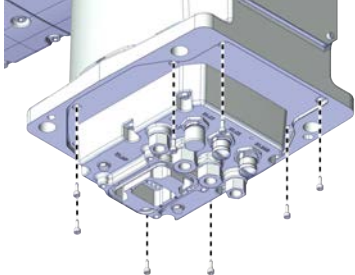
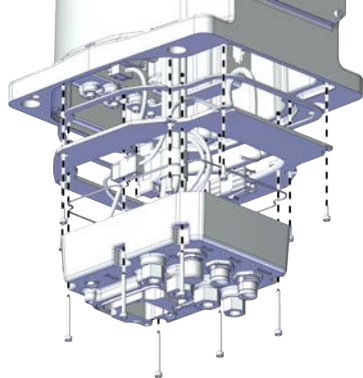
	Action	Note
5	<p>For underneath outlet cable version, refit the main harness assembly to the base.</p> <p> Note</p> <p>Refit the bottom plate to the main harness if needed.</p>	<p>For underneath outlet cable version:</p> <p>For robots with protection class IP30 (option 3350-300)</p> <p>Screws: Hex socket head cap screw M3x30 12.9 Lafre 2C2B/FC6.9 (8 pcs)</p> <p>Tightening torque: 1.2 Nm \pm10%</p>
6	Secure with the screws.	<p></p> <p>xx2100001204</p> <p>For robots with protection class IP54 (option 3350-540)</p> <p>For robots with protection type Clean Room (option 3351-1)</p> <p>Screws: Hex socket head cap screw M3x30 12.9 Lafre 2C2B/FC6.9 (8 pcs)</p> <p>Tightening torque: 1.2 Nm \pm10%</p> <p></p> <p>xx2100002437</p>

Refitting the base plate/ rear plate

	Action	Note
1	<p>For robots with protection type Clean Room:</p> <p>Clean the joints that have been opened and wipe the parts free from particles with spirit on a lint free. See Cut the paint or surface on the robot before replacing parts on page 118</p> <p> Note</p> <p>After all repair work, wipe the Clean Room robot free from particles with spirit on a lint free cloth.</p>	





Continues on next page

	Action	Note
2	Apply grease to the internal harness, cover all moving area of the harness.	

5 Repair

5.3.1 Replacing the main harness

Continued

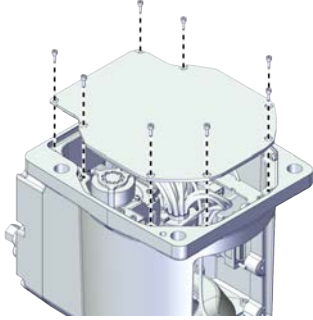
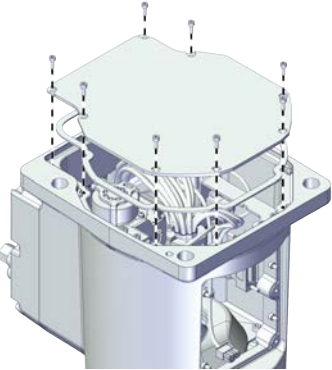
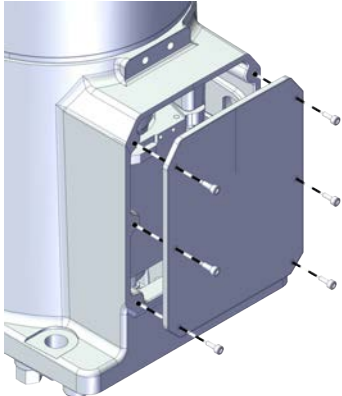
	Action	Note
3	<p>For rear outlet cable version, refit the base plate to the base.</p> <p> Note</p> <p>For robots with protection class IP54 (option 3350-540) For robots with protection type Clean Room (option 3351-1) Check the gasket for the base plate before refitting the base plate.</p> <p> Tip</p> <p>Replace the gasket if needed.</p> <p>For undeneath outlet cable version, refit the rear plate to the base.</p> <p> Note</p> <p>For robots with protection class IP54 (option 3350-540) For robots with protection type Clean Room (option 3351-1) Check the gasket for the rear plate before refitting the rear plate.</p> <p> Tip</p> <p>Replace the gasket if needed.</p>	<p>Screws: Hex socket head cap screw M3x30 12.9 Lafre 2C2B/FC6.9 (6 pcs) Tightening torque: 1.2 Nm \pm10%</p> <p>For rear outlet cable version: For robots with protection class IP30 (option 3350-300)</p>  <p>xx2100000946</p> <p>For robots with protection class IP54 (option 3350-540) For robots with protection type Clean Room (option 3351-1)</p> 
4	<p>Secure the base plate/ rear plate to the base with the screws.</p>	<p>For undeneath outlet cable version: For robots with protection class IP30 (option 3350-300)</p>  <p>xx2100001202</p>

Continues on next page

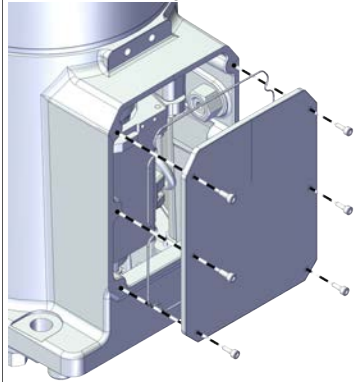
	Action	Note
		<p>For robots with protection class IP54 (option 3350-540) For robots with protection type Clean Room (option 3351-1)</p>  <p>xx2100002435</p>
5	Refit the robot back to the ground.	
6	Secure with the screws.	<p>Screws: Hex socket head cap screw M12x35 12.9 Gleitmo 603+Geomet 500 (4 pcs) Steel Washers: 24 mm x 13 mm x 2.5 mm (4 pcs) Tightening torque: 56 Nm ±10%</p>

Refitting the cable ferrule and bracket in the outer arm







	Action	Note
1	<p>For robots with protection type Clean Room: Clean the joints that have been opened and wipe the parts free from particles with spirit on a lint free. See Cut the paint or surface on the robot before replacing parts on page 118</p> <p> Note After all repair work, wipe the Clean Room robot free from particles with spirit on a lint free cloth.</p>	
2	Lay the internal harness in a natural state without distortion.	

Continues on next page

5 Repair

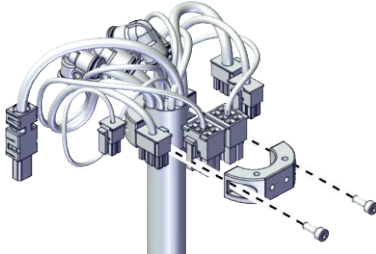

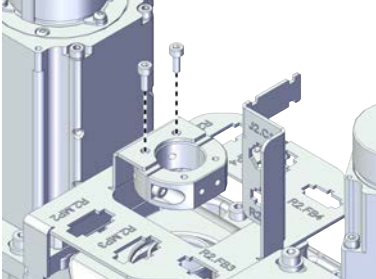



5.3.1 Replacing the main harness

Continued

	Action	Note
3	<p>Refit the cable ferrule and secure it with the screws.</p> <p> Tip</p> <p>The air hoses should face the process hub side.</p> <p> Tip</p> <p>The position with wrapped tape is the marked position for the cable ferrule.</p> <p> Tip</p> <p>Align all the cable ferrules so that the cable is in a natural bending position to avoid twisting.</p>	<p>Screws: Hex socket head cap screw M3x8 12.9 Lafre 2C2B/FC6.9 (2 pcs)</p> <p>Tightening torque: 1.2 Nm \pm10%</p>  <p>xx1800002849</p>
4	<p>Secure the cable ferrule to the bracket.</p> <p> Tip</p> <p>Align all the cable ferrules so that the cable is in a natural bending position to avoid twisting.</p> <p> Note</p> <p>The harness are not visible due to the cleanness requirements of the illustration. They are still existing inside the cable ferrule in the actual situation.</p>	<p>Screws: Hex socket head cap screw M3x8 12.9 Lafre 2C2B/FC6.9 (2 pcs)</p> <p>Tightening torque: 1.2 Nm \pm10%</p>  <p>xx2100000940</p>
5	<p>Refit the bracket without securing.</p> <p> Tip</p> <p>Do not secure it with the screws before the cable ferrule installed well.</p> <p> Note</p> <p>The harness are not visible due to the cleanness requirements of the illustration. They are still existing inside the cable ferrule in the actual situation.</p>	

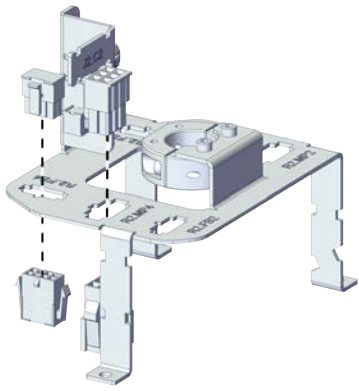
Continues on next page

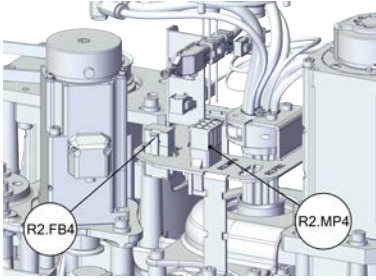
Reconnecting the connectors for axis-4 motor

	Action	Note
1	<p>For robots with protection type Clean Room: Clean the joints that have been opened and wipe the parts free from particles with spirit on a lint free. See Cut the paint or surface on the robot before replacing parts on page 118</p> <p> Note</p> <p>After all repair work, wipe the Clean Room robot free from particles with spirit on a lint free cloth.</p>	
	<p>Insert the female head of the connectors to the bracket accordingly.</p> <p> Tip</p> <p>The mistake proofing measure has been applied to the connectors, the connectors may be damaged if excessive force is used.</p> <p> Note</p> <p>The harness are not visible due to the cleanness requirements of the illustration. They are still existing inside the cable ferrule in the actual situation.</p>	 <p>xx2100000939</p>
2	<p>Reconnect the connectors.</p> <ul style="list-style-type: none"> • R2.MP4 • R2.FB4 <p> Tip</p> <p>See the number markings on the connectors for help to find the corresponding connector.</p>	 <p>xx2100000938</p>
3	<p>Route the cabling on the axis-4 motor.</p> <p> CAUTION</p> <p>Correct cable routing is highly important. If the cables are routed and secured incorrectly the cables can be damaged.</p>	







Continues on next page

5 Repair

5.3.1 Replacing the main harness

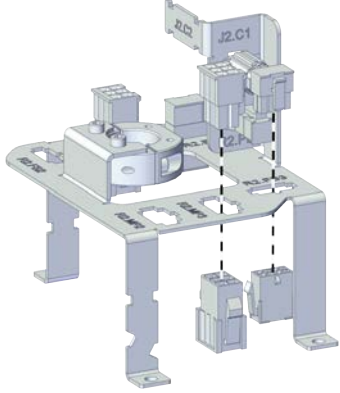

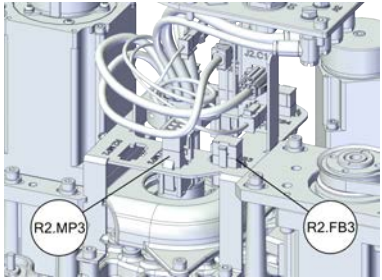



Continued

Reconnecting the connectors for axis-3 motor

	Action	Note
1	<p>For robots with protection type Clean Room: Clean the joints that have been opened and wipe the parts free from particles with spirit on a lint free. See Cut the paint or surface on the robot before replacing parts on page 118</p> <p> Note</p> <p>After all repair work, wipe the Clean Room robot free from particles with spirit on a lint free cloth.</p>	
2	<p>Insert the female head of the connectors to the bracket accordingly.</p> <p> Tip</p> <p>The mistake proofing measure has been applied to the connectors, the connectors may be damaged if excessive force is used.</p> <p> Note</p> <p>The harness are not visible due to the cleanness requirements of the illustration. They are still existing inside the cable ferrule in the actual situation.</p>	 <p>xx2100000937</p>
3	<p>Reconnect the connectors.</p> <ul style="list-style-type: none"> • R2.MP3 • R2.FB3 <p> Tip</p> <p>See the number markings on the connectors for help to find the corresponding connector.</p>	 <p>xx2100000936</p>
4	<p>Route the cabling on the axis-3 motor.</p> <p> CAUTION</p> <p>Correct cable routing is highly important. If the cables are routed and secured incorrectly the cables can be damaged.</p>	

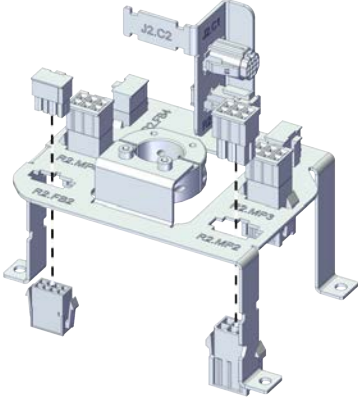
Continues on next page

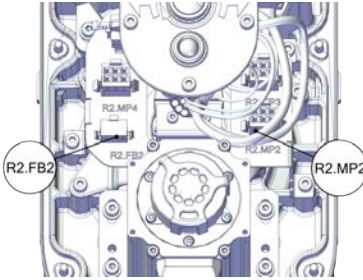
Reconnecting the connectors for axis-2 motor

	Action	Note
1	<p>For robots with protection type Clean Room: Clean the joints that have been opened and wipe the parts free from particles with spirit on a lint free. See Cut the paint or surface on the robot before replacing parts on page 118</p> <p> Note</p> <p>After all repair work, wipe the Clean Room robot free from particles with spirit on a lint free cloth.</p>	
2	<p>Insert the female head of the connectors to the bracket accordingly.</p> <p> Tip</p> <p>The mistake proofing measure has been applied to the connectors, the connectors may be damaged if excessive force is used.</p> <p> Note</p> <p>The harness are not visible due to the cleanness requirements of the illustration. They are still existing inside the cable ferrule in the actual situation.</p>	 <p>xx2100000935</p>
3	<p>Reconnect the connectors.</p> <ul style="list-style-type: none"> • R2.MP2 • R2.FB2 <p> Tip</p> <p>See the number markings on the connectors for help to find the corresponding connector.</p>	 <p>xx2100000934</p>
4	<p>Route the cabling behind the axis-2 motor.</p> <p> CAUTION</p> <p>Correct cable routing is highly important. If the cables are routed and secured incorrectly the cables can be damaged.</p>	







Continues on next page

5 Repair

5.3.1 Replacing the main harness

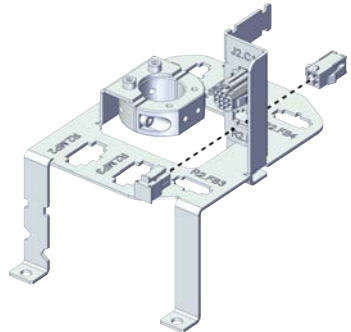

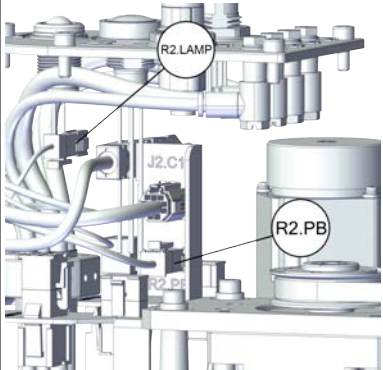
Continued

Reconnecting the connector for PB

	Action	Note
1	<p>For robots with protection type Clean Room: Clean the joints that have been opened and wipe the parts free from particles with spirit on a lint free. See Cut the paint or surface on the robot before replacing parts on page 118</p> <p> Note</p> <p>After all repair work, wipe the Clean Room robot free from particles with spirit on a lint free cloth.</p>	
2	<p>Insert the female head of the PB connector to the bracket accordingly.</p> <p> Tip</p> <p>The mistake proofing measure has been applied to the connectors, the connectors may be damaged if excessive force is used.</p> <p> Note</p> <p>The harness are not visible due to the cleanness requirements of the illustration. They are still existing inside the cable ferrule in the actual situation.</p>	 <p>xx2100001031</p>
3	<p>Reconnect the connector.</p> <ul style="list-style-type: none"> • R2.PB • R2.LAMP <p> Tip</p> <p>See the number markings on the connectors for help to find the corresponding connector.</p>	 <p>xx2100001030</p>
4	<p>Route and secure the cabling with cable straps if needed.</p> <p> CAUTION</p> <p>Correct cable routing is highly important. If the cables are routed incorrectly the cables can be damaged.</p>	

Continues on next page

Reconnecting the air hoses, CP/CS cabling and Ethernet cabling (if equipped)







	Action	Note
1	<p>For robots with protection type Clean Room: Clean the joints that have been opened and wipe the parts free from particles with spirit on a lint free. See Cut the paint or surface on the robot before replacing parts on page 118</p> <p> Note</p> <p>After all repair work, wipe the Clean Room robot free from particles with spirit on a lint free cloth.</p>	
2	<p>Route the air hoses on the process hub behind the bracket.</p> <p> CAUTION</p> <p>Correct cable routing is highly important. If the cables are routed and secured incorrectly the cables can be damaged.</p>	

Continues on next page

5 Repair

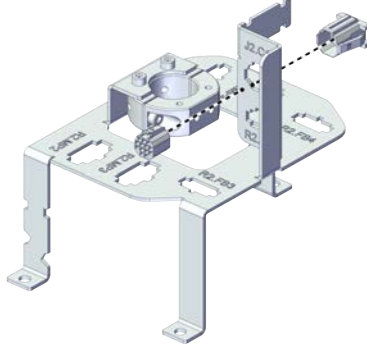
5.3.1 Replacing the main harness

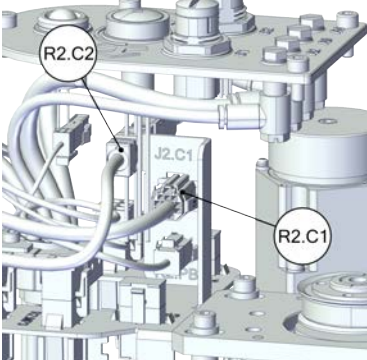

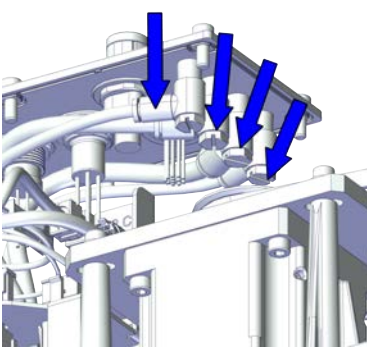
Continued

	Action	Note
3	<p>Insert the female head of the C1 cabling connector to the bracket accordingly.</p> <p> Tip</p> <p>The mistake proofing measure has been applied to the connectors, the connectors may be damaged if excessive force is used.</p> <p> Note</p> <p>The harness are not visible due to the cleanness requirements of the illustration. They are still existing inside the cable ferrule in the actual situation.</p>	 <p>xx2100001034</p>
4	<p>For robots with C1 cabling</p> <p>Reconnect the connector.</p> <ul style="list-style-type: none"> • R2.C1 <p> Tip</p> <p>See the number markings on the air hoses for help to find the corresponding air hoses.</p> <p>The air hoses with the same number connect to the same L-shaped connector.</p>	 <p>xx2100001033</p>
5	<p>For robots with C2 cabling</p> <p>Reconnect the connector.</p> <ul style="list-style-type: none"> • R1.C2 <p> Tip</p> <p>See the number markings on the air hoses for help to find the corresponding air hoses.</p> <p>The air hoses with the same number connect to the same L-shaped connector.</p>	
6	<p>Secure the C2 cabling to the C2 bracket with the cable straps.</p>	
7	<p>Reconnect the air hoses in a cross pattern with the L-shaped connectors.</p> <p> Tip</p> <p>See the number markings on the air hoses for help to find the corresponding air hoses.</p> <p>The air hoses with the same number connect to the same Y-shaped connector.</p>	 <p>xx2100001032</p>

Continues on next page

	Action	Note
8	<p>Route and secure the cabling with cable straps if needed.</p> <p> CAUTION</p> <p>Correct cable routing is highly important. If the cables are routed and secured incorrectly the cables can be damaged.</p>	

Securing the bracket in the outer arm

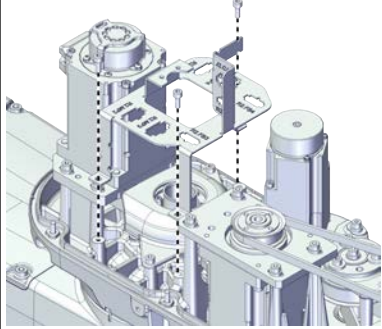
	Action	Note
1	<p>For robots with protection type Clean Room: Clean the joints that have been opened and wipe the parts free from particles with spirit on a lint free. See Cut the paint or surface on the robot before replacing parts on page 118</p> <p> Note</p> <p>After all repair work, wipe the Clean Room robot free from particles with spirit on a lint free cloth.</p>	
2	<p>Refit the bracket.</p> <p> Tip</p> <p>Do not secure it with the screws before the cable ferrule installed well.</p> <p> Note</p> <p>The harness are not visible due to the cleanness requirements of the illustration. They are still existing inside the cable ferrule in the actual situation.</p>	<p>Screws: Hex socket head cap screw M4x10 12.9 Lafre 2C2B/FC6.9 (3 pcs) Tightening torque: 1.2 Nm ±10%</p>  <p>xx2100000941</p>

Refitting the cover of the outer arm



	Action	Note
1	<p>For robots with protection type Clean Room: Clean the joints that have been opened and wipe the parts free from particles with spirit on a lint free. See Cut the paint or surface on the robot before replacing parts on page 118</p> <p> Note</p> <p>After all repair work, wipe the Clean Room robot free from particles with spirit on a lint free cloth.</p>	

Continues on next page

5 Repair

5.3.1 Replacing the main harness

Continued

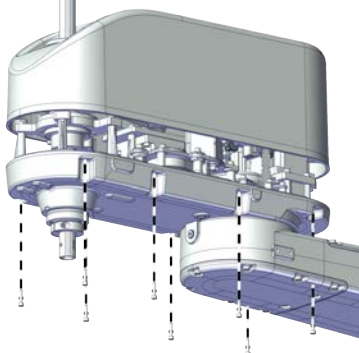
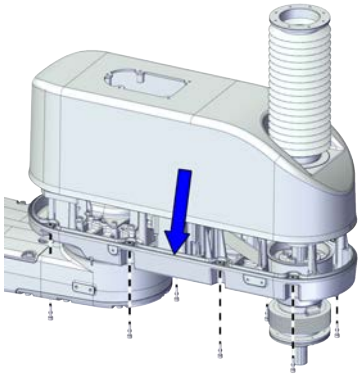

	Action	Note
2	<p>Refit the cover.</p> <p> Note</p> <p>For robots with protection class IP54 (option 3350-540)</p> <p>For robots with protection type Clean Room (option 3351-1)</p> <p>Refit the cover with bellow.</p> <p>Check the gasket for the outer arm cover.</p> <p> Tip</p> <p>Replace the gasket if needed.</p> <p> CAUTION</p> <p>The gasket is in the outer arm.</p>	<p>Screw: Hex socket head cap screw M4x16 12.9 Lafre 2C2B/FC6.9 (8 pcs)</p> <p>Tightening torque: 2 Nm ±10%</p> <p>For robots with protection class IP30 (option 3350-300)</p>  <p>xx210000933</p>
3	<p>Refit the screws.</p>	<p>For robots with protection class IP54 (option 3350-540)</p> <p>For robots with protection type Clean Room (option 3351-1)</p>  <p>xx2100002427</p>

For Clean Room/ IP54 robots

Refitting the top cover and the flange with bearing

	Action	Note
1	<p>For robots with protection type Clean Room:</p> <p>Clean the joints that have been opened and wipe the parts free from particles with spirit on a lint free. See Cut the paint or surface on the robot before replacing parts on page 118</p> <p> Note</p> <p>After all repair work, wipe the Clean Room robot free from particles with spirit on a lint free cloth.</p>	

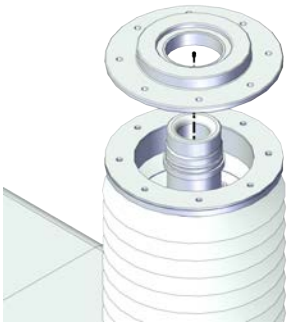
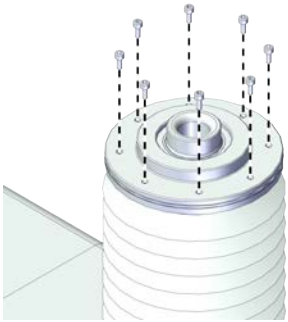
Continues on next page

	Action	Note
2	<p>For robots with protection class IP54 (option 3350-540) For robots with protection type Clean Room (option 3351-1) Install the flange with bearing to the extension shaft.</p>	 <p>xx2100002402</p>
3	<p>For robots with protection class IP54 (option 3350-540) For robots with protection type Clean Room (option 3351-1) Refit the screws to the flange with bearing.</p>	<p>Screws: Hex socket head cap screw M2.5x6 12.9 Lafre 2C2B/FC6.9 (8 pcs) Tightening torque: 0.8 Nm ±10%</p>  <p>xx2100002401</p>
4	<p>For robots with protection class IP54 (option 3350-540) For robots with protection type Clean Room (option 3351-1) Refit the top cover to the ball screw.</p> <p> Tip</p> <p>The top surface of the cover should be flush with the top end of the ball screw.</p>	 <p>xx2100002399</p>

Continues on next page

5 Repair

5.3.1 Replacing the main harness

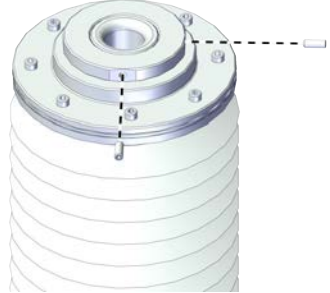

Continued

	Action	Note
5	<p>For robots with protection class IP54 (option 3350-540)</p> <p>For robots with protection type Clean Room (option 3351-1)</p> <p>Refit the locking screws.</p>	<p>Screws: Hexagon socket set screws with flat point, ISO 4026 stainless steel M3x8 (2 pcs)</p> <p>Tightening torque: 0.4 Nm \pm10%</p>  <p>xx2100002398</p>

Securing the process hub to outer arm cover

	Action	Note
1	<p>For robots with protection type Clean Room:</p> <p>Clean the joints that have been opened and wipe the parts free from particles with spirit on a lint free. See Cut the paint or surface on the robot before replacing parts on page 118</p> <p> Note</p> <p>After all repair work, wipe the Clean Room robot free from particles with spirit on a lint free cloth.</p>	
2	Insert the process hub from the outer arm cover.	

Continues on next page

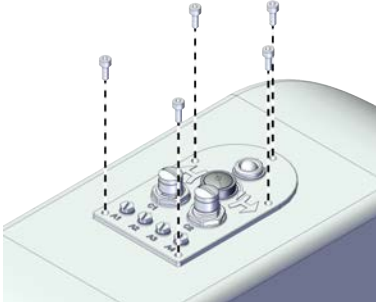
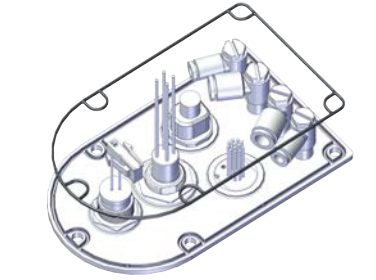
	Action	Note
3	<p>Secure the process hub to the outer arm cover with the screws.</p> <p> Note</p> <p>For robots with protection class IP54 (option 3350-540)</p> <p>For robots with protection type Clean Room (option 3351-1)</p> <p>Check the gasket for the process hub.</p> <p> Tip</p> <p>Replace the gasket if needed.</p> <p> CAUTION</p> <p>Be aware of the cabling that is attached to the cover! The cover can not be removed completely until the connectors are disconnected, as shown in following steps.</p>	<p>Screws: Hex socket head cap screw M4x10 12.9 Lafre 2C2B/FC6.9 (5 pcs)</p> <p>Tightening torque: 2.6 Nm±10%</p> <p>For robots with protection class IP30 (option 3350-300)</p>  <p>xx2100000932</p> <p>For robots with protection class IP54 (option 3350-540)</p> <p>For robots with protection type Clean Room (option 3351-1)</p>  <p>xx2100002438</p>



Refitting the axis-1 cover

	Action	Note
1	<p>For robots with protection type Clean Room:</p> <p>Clean the joints that have been opened and wipe the parts free from particles with spirit on a lint free. See Cut the paint or surface on the robot before replacing parts on page 118</p> <p> Note</p> <p>After all repair work, wipe the Clean Room robot free from particles with spirit on a lint free cloth.</p>	

5 Repair

5.3.1 Replacing the main harness

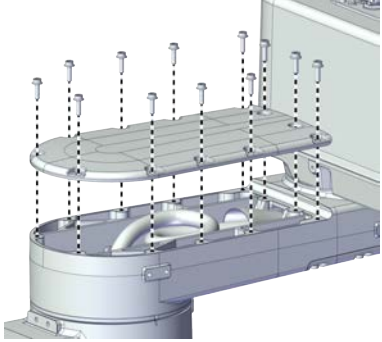
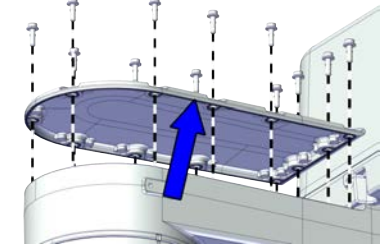

Continued

	Action	Note
2	<p>Refit the cover.</p> <p> Note</p> <p>For robots with protection class IP54 (option 3350-540)</p> <p>For robots with protection type Clean Room (option 3351-1)</p> <p>Check the gasket for the cover before refitting the cover.</p> <p> Tip</p> <p>Replace the gasket if needed.</p>	<p>For IRB 920T-6/0.45 : Screw: Hex socket head cap flange screw M5x16 12.9 Lafre 2C2B/FC6.9+PrO-COat111 (10 pcs)</p> <p>For IRB 920T-6/0.55 : Screw: Hex socket head cap flange screw M5x16 12.9 Lafre 2C2B/FC6.9+PrO-COat111 (12 pcs)</p> <p>For IRB 920T-6/0.65 : Screw: Hex socket head cap flange screw M5x16 12.9 Lafre 2C2B/FC6.9+PrO-COat111 (16 pcs)</p> <p>Tightening torque: 5.4 Nm \pm3%</p> <p>For robots with protection class IP30 (option 3350-300)</p>
3	<p>Refit the screws.</p>	 <p>xx2100000942</p> <p>For robots with protection class IP54 (option 3350-540)</p> <p>For robots with protection type Clean Room (option 3351-1)</p>  <p>xx2100002428</p>

Refitting the axis-2 cover

	Action	Note
1	<p> DANGER</p> <p>Make sure that all supplies for electrical power, hydraulic pressure, and air pressure are turned off.</p>	

Continues on next page

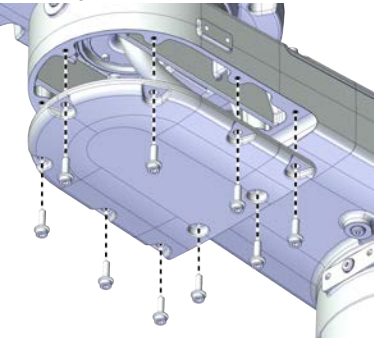
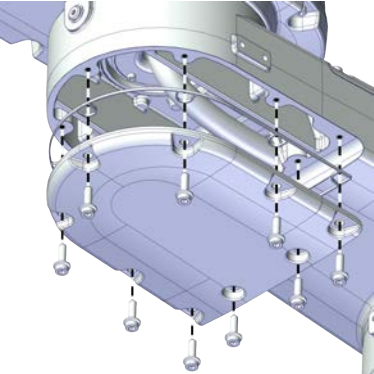
	Action	Note
2	<p> CAUTION</p> <p>For robots with protection type Clean Room Always cut the paint with a knife and grind the paint edge when disassembling parts of the robot! See <i>Cut the paint or surface on the robot before replacing parts on page 118.</i></p>	
3	<p>Refit the cover.</p> <p> Note</p> <p>For robots with protection class IP54 (option 3350-540) For robots with protection type Clean Room (option 3351-1) Check the gasket for the cover before refitting the cover.</p> <p> Tip</p> <p>Replace the gasket if needed.</p>	<p>Screws: Hex socket head cap flange screw M5x16 12.9 Lafre 2C2B/FC6.9+PrO-COat111 (9 pcs) Tightening torque: 1.2 Nm ±10%</p> <p>For robots with protection class IP30 (option 3350-300)</p>  <p>xx210000943</p>
4	<p>Refit the screws.</p>	<p>For robots with protection class IP54 (option 3350-540) For robots with protection type Clean Room (option 3351-1)</p>  <p>xx2100002451</p>



Continues on next page

5 Repair

5.3.1 Replacing the main harness

Continued

Concluding procedure

	Action	Note
1	<p>For robots with protection type Clean Room: Seal and paint the joints that have been opened. See Cut the paint or surface on the robot before replacing parts on page 118</p> <p> Note</p> <p>After all repair work, wipe the Clean Room robot free from particles with spirit on a lint free cloth.</p>	
2	Recalibrate the robot.	Calibration is detailed in section Calibration on page 945 .
3	<p> DANGER</p> <p>Make sure all safety requirements are met when performing the first test run.</p>	

5.3.2 Replacing the process hub

Location of the process hub

The process hub is located as shown in the figure.

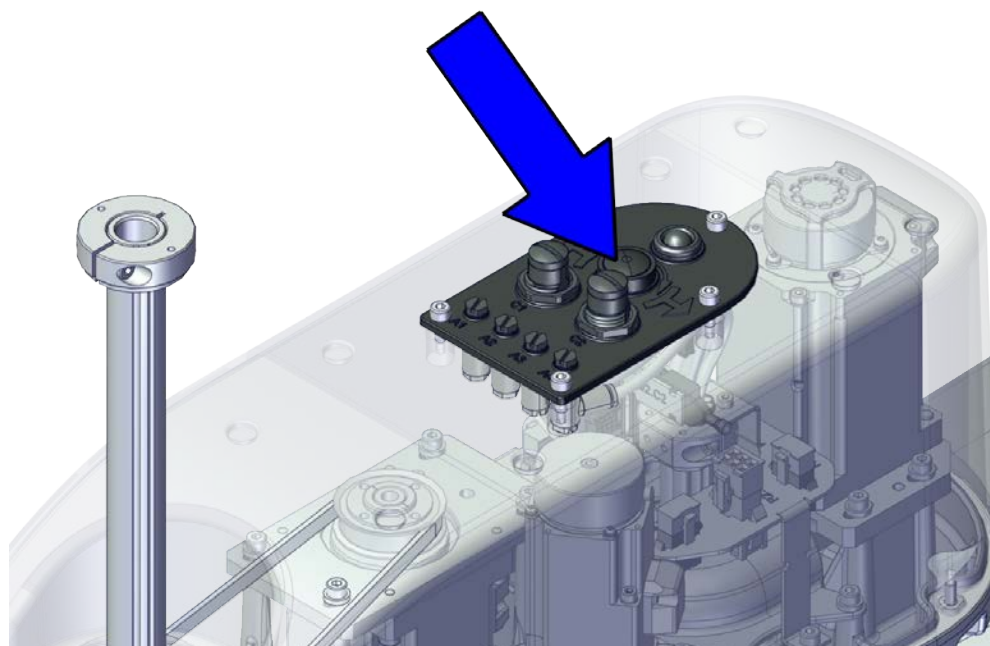

xx2100001009

Required spare parts



Note

The spare part numbers that are listed in the table can be out of date. See the latest spare parts of the IRB 920 via myABB Business Portal, www.abb.com/myABB.

Spare part	Article number	Note
Process hub, M, Basic	3HAC076583-001	
Process hub, M, Basic+C1+A	3HAC076584-001	
Process hub, M, Basic+C1+C2+A	3HAC076585-001	
Outer arm cover	3HAC076611-001	
Gasket, Process hub	3HAC073940-001	

Required tools and equipment

Equipment	Article number	Note
Standard toolkit	-	Content is defined in section Standard toolkit on page 996 .

Continues on next page

5 Repair

5.3.2 Replacing the process hub

Continued

Equipment	Article number	Note
Calibration toolbox, Axis Calibration	3HAC055412-001	Delivered as a set of calibration tools. Required if Axis Calibration is the valid calibration method for the robot.

Required consumables

Consumable	Article number	Note
Cable straps	-	
Grease	3HAC029132-001	FM 222

Deciding calibration routine

Decide which calibration routine to be used, based on the information in the table. Depending on which routine is chosen, action might be required prior to beginning the repair work of the robot, see the table.

	Action	Note
1	Decide which calibration routine to use for calibrating the robot. <ul style="list-style-type: none">Reference calibration. External cable packages (DressPack) and tools can stay fitted on the robot.Fine calibration. All external cable packages (DressPack) and tools must be removed from the robot.	
	If the robot is to be calibrated with reference calibration: Find previous reference values for the axis or create new reference values. These values are to be used after the repair procedure is completed, for calibration of the robot. If no previous reference values exist, and no new reference values can be created, then reference calibration is not possible.	Follow the instructions given in the reference calibration routine on the FlexPendant to create reference values. Creating new values requires possibility to move the robot. Read more about reference calibration for Axis Calibration in Reference calibration routine on page 957 .
	If the robot is to be calibrated with fine calibration: Remove all external cable packages (DressPack) and tools from the robot.	



Removing the process hub

Use these procedures to remove the process hub.

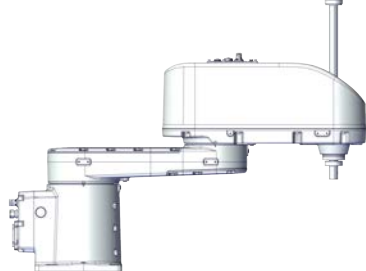

Preparations before removing the process hub

	Action	Note
1	Decide which calibration routine to use, and take actions accordingly prior to beginning the repair procedure.	

Continues on next page

	Action	Note
2	Jog all axes to zero position.	 xx2100000930
3	 DANGER Turn off all: <ul style="list-style-type: none"> • electric power supply • hydraulic pressure supply • air pressure supply to the robot, before entering the safeguarded space.	
4	 CAUTION For robots with protection type Clean Room Always cut the paint with a knife and grind the paint edge when disassembling parts of the robot! See Cut the paint or surface on the robot before replacing parts on page 118 .	



Removing the process hub screws

	Action	Note
1	 DANGER Make sure that all supplies for electrical power, hydraulic pressure, and air pressure are turned off.	
2	 CAUTION For robots with protection type Clean Room Always cut the paint with a knife and grind the paint edge when disassembling parts of the robot! See Cut the paint or surface on the robot before replacing parts on page 118 .	

5 Repair

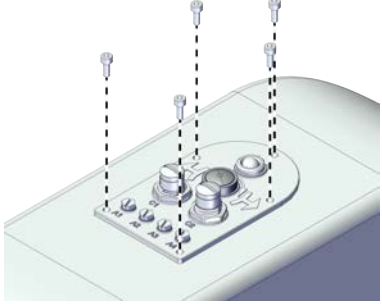
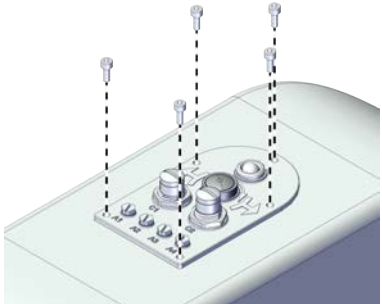

5.3.2 Replacing the process hub

Continued



	Action	Note
3	<p>Remove the screws on the process hub.</p> <p> Note</p> <p>For robots with protection class IP54 (option 3350-540)</p> <p>For robots with protection type Clean Room (option 3351-1)</p> <p>Remove the screws on the process hub and take out the gasket.</p> <p> Tip</p> <p>Check the gasket and replace it if needed.</p>	<p>For robots with protection class IP30</p>  <p>xx210000932</p> <p>For robots with protection class IP54 (option 3350-540)</p> <p>For robots with protection type Clean Room (option 3351-1)</p>  <p>xx210000932</p>
4	Insert the process hub to the outer arm.	

For Clean Room/ IP54 robots

Removing the top cover and the flange with bearing

	Action	Note
1	<p> DANGER</p> <p>Make sure that all supplies for electrical power, hydraulic pressure, and air pressure are turned off.</p>	
2	<p> CAUTION</p> <p>For robots with protection type Clean Room</p> <p>Always cut the paint with a knife and grind the paint edge when disassembling parts of the robot! See Cut the paint or surface on the robot before replacing parts on page 118.</p>	

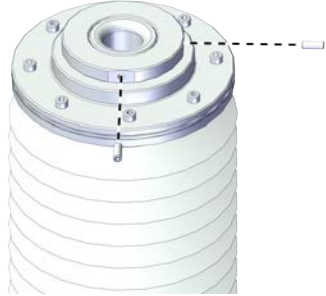
Continues on next page

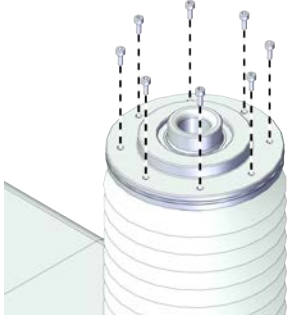
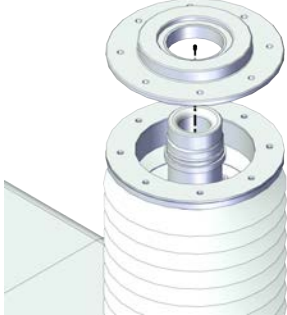
	Action	Note
3	<p>For robots with protection class IP54 (option 3350-540) For robots with protection type Clean Room (option 3351-1) Loose the locking screws.</p>	 <p>xx2100002398</p>
4	<p>For robots with protection class IP54 (option 3350-540) For robots with protection type Clean Room (option 3351-1) Remove the top cover from the ball screw.</p>	 <p>xx2100002399</p>
5	<p>For robots with protection class IP54 (option 3350-540) For robots with protection type Clean Room (option 3351-1) Remove the screws on the flange with bearing.</p>	 <p>xx2100002401</p>
6	<p>For robots with protection class IP54 (option 3350-540) For robots with protection type Clean Room (option 3351-1) Remove the flange with bearing.</p>	 <p>xx2100002402</p>





Continues on next page

5 Repair

5.3.2 Replacing the process hub

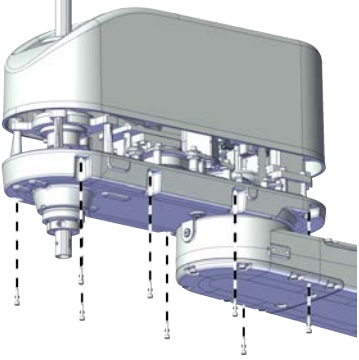
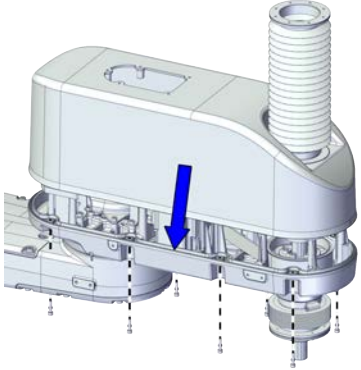

Continued

Removing the cover of the outer arm



	Action	Note
1	 DANGER Make sure that all supplies for electrical power, hydraulic pressure, and air pressure are turned off.	
2	 CAUTION For robots with protection type Clean Room Always cut the paint with a knife and grind the paint edge when disassembling parts of the robot! See Cut the paint or surface on the robot before replacing parts on page 118 .	
3	Remove the screws on the cover of the outer arm and remove the cover.  Note For robots with protection class IP54 (option 3350-540) For robots with protection type Clean Room (option 3351-1) Remove the cover with bellow and housing.  Note The bellow does not need to be removed separately.  Tip Check the gasket and replace it if needed.	For robots with protection class IP30  xx210000933 For robots with protection class IP54 (option 3350-540) For robots with protection type Clean Room (option 3351-1)  xx2100002427

Continues on next page

Releasing the straps on the bracket

	Action	Note
1	 DANGER Make sure that all supplies for electrical power, hydraulic pressure, and air pressure are turned off.	
2	 CAUTION For robots with protection type Clean Room Always cut the paint with a knife and grind the paint edge when disassembling parts of the robot! See Cut the paint or surface on the robot before replacing parts on page 118 .	
3	Cut the straps on the base bracket.	

Disconnecting the air hoses, C1 cabling and C2 cabling (if equipped)

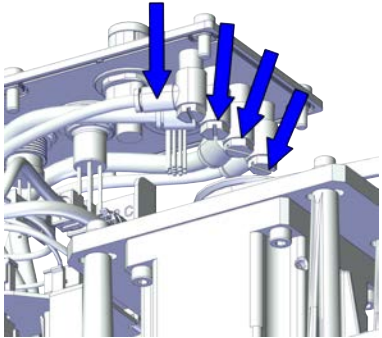





	Action	Note
1	 DANGER Make sure that all supplies for electrical power, hydraulic pressure, and air pressure are turned off.	
2	 CAUTION For robots with protection type Clean Room Always cut the paint with a knife and grind the paint edge when disassembling parts of the robot! See Cut the paint or surface on the robot before replacing parts on page 118 .	
3	Disconnect the air hoses from the L-shaped connectors.	 <p>xx2100001032</p>

Continues on next page

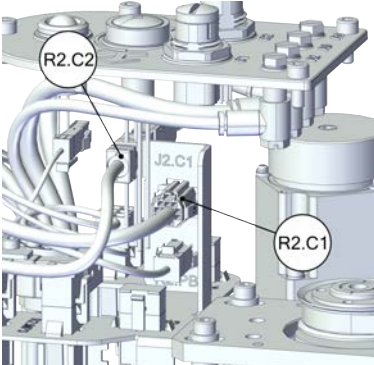
5 Repair



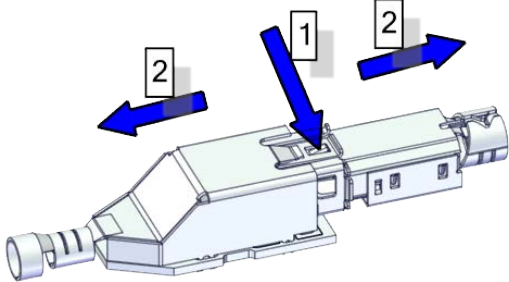

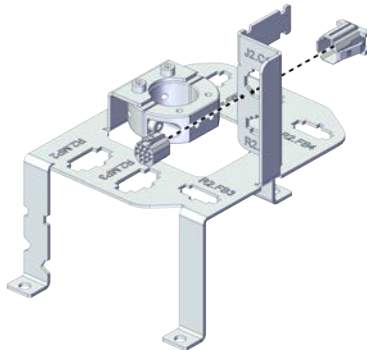
5.3.2 Replacing the process hub

Continued

	Action	Note
4	<p>For robots with C1 cabling Disconnect the connector.</p> <ul style="list-style-type: none"> • R2.C1 	
5	<p>For robots with C2 cabling Disconnect the connector.</p> <ul style="list-style-type: none"> • R1.C2 <p> Tip</p> <p>Cut the cable straps for the R1.C2 at the same time.</p> <p> Tip</p> <p>Take photos of the connector and cable position before disconnecting them, to have as a reference when reconnecting.</p> <p> Tip</p> <p>The connector clip has to be pressed (1) and pushed forward (2) to separate the R1.C2 (for C2 cabling).</p>  <p>xx1800002943</p>	<p>xx2100001033</p>
6	<p>Snap loose and remove the female head of the connectors from the bracket.</p> <p> Note</p> <p>The harness are not visible due to the cleanliness requirements of the illustration. They are still existing inside the cable ferrule in the actual situation.</p>	 <p>xx2100001034</p>

Continues on next page

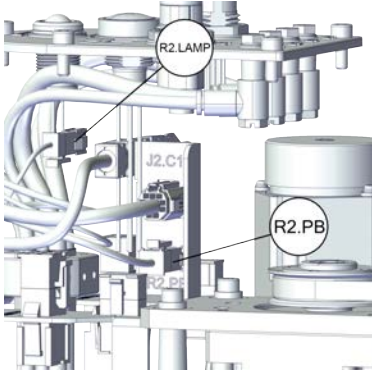
Disconnecting the connector for PB

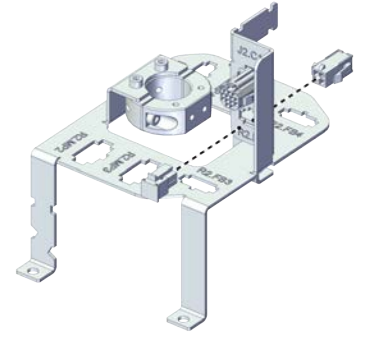
	Action	Note
1	 DANGER Make sure that all supplies for electrical power, hydraulic pressure, and air pressure are turned off.	
2	 CAUTION For robots with protection type Clean Room Always cut the paint with a knife and grind the paint edge when disassembling parts of the robot! See Cut the paint or surface on the robot before replacing parts on page 118 .	
3	Disconnect the connector. <ul style="list-style-type: none"> • R2.PB • R2.LAMP 	 <p>xx2100001030</p>
4	Snap loose and remove the female head of the connector from the bracket.  Note The harness are not visible due to the cleanliness requirements of the illustration. They are still existing inside the cable ferrule in the actual situation.	 <p>xx2100001031</p>

Pull out the process hub





	Action	Note
1	 DANGER Make sure that all supplies for electrical power, hydraulic pressure, and air pressure are turned off.	

Continues on next page

5 Repair

5.3.2 Replacing the process hub

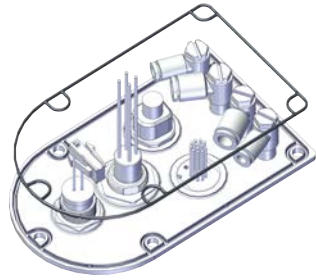

Continued

	Action	Note
2	 CAUTION For robots with protection type Clean Room Always cut the paint with a knife and grind the paint edge when disassembling parts of the robot! See Cut the paint or surface on the robot before replacing parts on page 118 .	
3	Take out the process hub.  Note For robots with protection class IP54 (option 3350-540) For robots with protection type Clean Room (option 3351-1) Check the gasket for the process hub.  Tip Replace the gasket if needed.  CAUTION Be aware of the cabling that is attached to the cover! The cover can not be removed completely until the connectors are disconnected, as shown in following steps.	For robots with protection class IP54 (option 3350-540) For robots with protection type Clean Room (option 3351-1)  xx2100002438







Refitting the process hub

Use these procedures to refit the process hub.

Reconnecting the air hoses, CP/CS cabling and Ethernet cabling (if equipped)

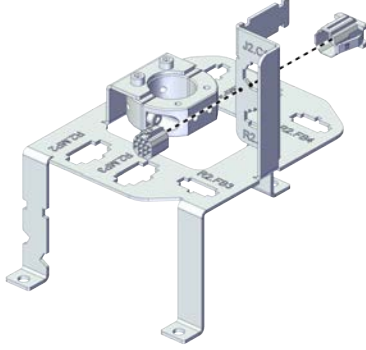
	Action	Note
1	For robots with protection type Clean Room: Clean the joints that have been opened and wipe the parts free from particles with spirit on a lint free. See Cut the paint or surface on the robot before replacing parts on page 118  Note After all repair work, wipe the Clean Room robot free from particles with spirit on a lint free cloth.	
2	Route the air hoses on the process hub behind the bracket.  CAUTION Correct cable routing is highly important. If the cables are routed and secured incorrectly the cables can be damaged.	

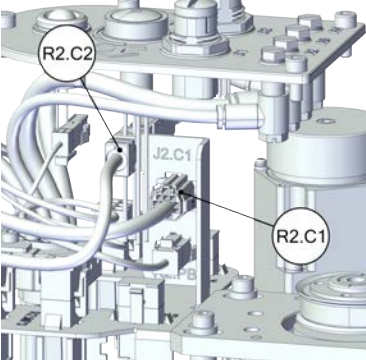
Continues on next page

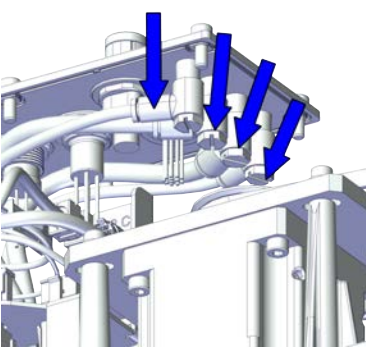
	Action	Note
3	<p>Insert the female head of the C1 cabling connector to the bracket accordingly.</p> <p> Tip</p> <p>The mistake proofing measure has been applied to the connectors, the connectors may be damaged if excessive force is used.</p> <p> Note</p> <p>The harness are not visible due to the cleanness requirements of the illustration. They are still existing inside the cable ferrule in the actual situation.</p>	 <p>xx2100001034</p>
4	<p>For robots with C1 cabling</p> <p>Reconnect the connector.</p> <ul style="list-style-type: none"> • R2.C1 <p> Tip</p> <p>See the number markings on the air hoses for help to find the corresponding air hoses.</p> <p>The air hoses with the same number connect to the same L-shaped connector.</p>	 <p>xx2100001033</p>
5	<p>For robots with C2 cabling</p> <p>Reconnect the connector.</p> <ul style="list-style-type: none"> • R1.C2 <p> Tip</p> <p>See the number markings on the air hoses for help to find the corresponding air hoses.</p> <p>The air hoses with the same number connect to the same L-shaped connector.</p>	
6	<p>Secure the C2 cabling to the C2 bracket with the cable straps.</p>	
7	<p>Reconnect the air hoses in a cross pattern with the L-shaped connectors.</p> <p> Tip</p> <p>See the number markings on the air hoses for help to find the corresponding air hoses.</p> <p>The air hoses with the same number connect to the same Y-shaped connector.</p>	 <p>xx2100001032</p>

Continues on next page





5 Repair

5.3.2 Replacing the process hub

Continued

	Action	Note
8	<p>Route and secure the cabling with cable straps if needed.</p> <p> CAUTION</p> <p>Correct cable routing is highly important. If the cables are routed and secured incorrectly the cables can be damaged.</p>	

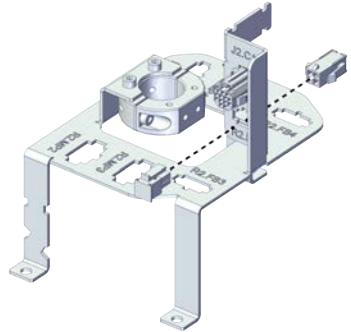
Reconnecting the connector for PB

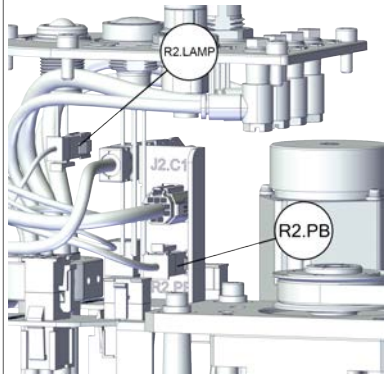
	Action	Note
1	<p>For robots with protection type Clean Room: Clean the joints that have been opened and wipe the parts free from particles with spirit on a lint free. See Cut the paint or surface on the robot before replacing parts on page 118</p> <p> Note</p> <p>After all repair work, wipe the Clean Room robot free from particles with spirit on a lint free cloth.</p>	
2	<p>Insert the female head of the PB connector to the bracket accordingly.</p> <p> Tip</p> <p>The mistake proofing measure has been applied to the connectors, the connectors may be damaged if excessive force is used.</p> <p> Note</p> <p>The harness are not visible due to the cleanliness requirements of the illustration. They are still existing inside the cable ferrule in the actual situation.</p>	 <p>xx2100001031</p>
3	<p>Reconnect the connector.</p> <ul style="list-style-type: none"> • R2.PB • R2.LAMP <p> Tip</p> <p>See the number markings on the connectors for help to find the corresponding connector.</p>	 <p>xx2100001030</p>

Continues on next page

	Action	Note
4	<p>Route and secure the cabling with cable straps if needed.</p> <p> CAUTION</p> <p>Correct cable routing is highly important. If the cables are routed incorrectly the cables can be damaged.</p>	



Refitting the cover of the outer arm

	Action	Note
1	<p>For robots with protection type Clean Room: Clean the joints that have been opened and wipe the parts free from particles with spirit on a lint free. See Cut the paint or surface on the robot before replacing parts on page 118</p> <p> Note</p> <p>After all repair work, wipe the Clean Room robot free from particles with spirit on a lint free cloth.</p>	

5 Repair

5.3.2 Replacing the process hub

Continued

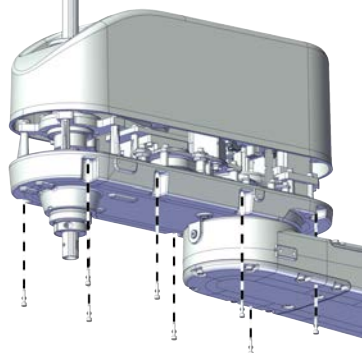
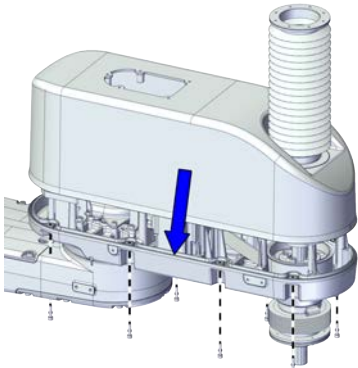

	Action	Note
2	<p>Refit the cover.</p> <p> Note</p> <p>For robots with protection class IP54 (option 3350-540)</p> <p>For robots with protection type Clean Room (option 3351-1)</p> <p>Refit the cover with bellow.</p> <p>Check the gasket for the outer arm cover.</p> <p> Tip</p> <p>Replace the gasket if needed.</p> <p> CAUTION</p> <p>The gasket is in the outer arm.</p>	<p>Screw: Hex socket head cap screw M4x16 12.9 Lafre 2C2B/FC6.9 (8 pcs)</p> <p>Tightening torque: 2 Nm ±10%</p> <p>For robots with protection class IP30 (option 3350-300)</p>  <p>xx210000933</p>
3	<p>Refit the screws.</p>	<p>For robots with protection class IP54 (option 3350-540)</p> <p>For robots with protection type Clean Room (option 3351-1)</p>  <p>xx2100002427</p>

For Clean Room/ IP54 robots

Refitting the top cover and the flange with bearing

	Action	Note
1	<p>For robots with protection type Clean Room:</p> <p>Clean the joints that have been opened and wipe the parts free from particles with spirit on a lint free. See Cut the paint or surface on the robot before replacing parts on page 118</p> <p> Note</p> <p>After all repair work, wipe the Clean Room robot free from particles with spirit on a lint free cloth.</p>	

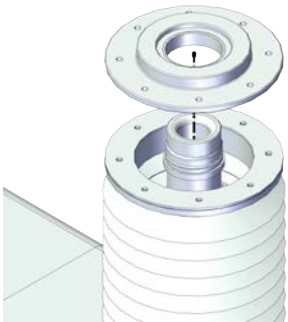
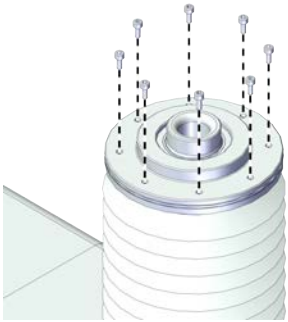
Continues on next page

	Action	Note
2	<p>For robots with protection class IP54 (option 3350-540) For robots with protection type Clean Room (option 3351-1) Install the flange with bearing to the extension shaft.</p>	 <p>xx2100002402</p>
3	<p>For robots with protection class IP54 (option 3350-540) For robots with protection type Clean Room (option 3351-1) Refit the screws to the flange with bearing.</p>	<p>Screws: Hex socket head cap screw M2.5x6 12.9 Lafre 2C2B/FC6.9 (8 pcs) Tightening torque: 0.8 Nm ±10%</p>  <p>xx2100002401</p>
4	<p>For robots with protection class IP54 (option 3350-540) For robots with protection type Clean Room (option 3351-1) Refit the top cover to the ball screw.</p> <p> Tip</p> <p>The top surface of the cover should be flush with the top end of the ball screw.</p>	 <p>xx2100002399</p>

Continues on next page

5 Repair

5.3.2 Replacing the process hub

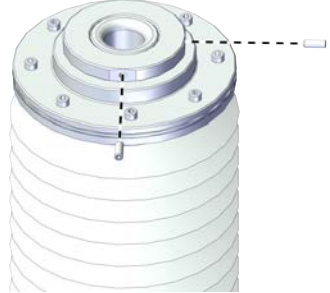

Continued

	Action	Note
5	<p>For robots with protection class IP54 (option 3350-540)</p> <p>For robots with protection type Clean Room (option 3351-1)</p> <p>Refit the locking screws.</p>	<p>Screws: Hexagon socket set screws with flat point, ISO 4026 stainless steel M3x8 (2 pcs)</p> <p>Tightening torque: 0.4 Nm \pm10%</p>  <p>xx2100002398</p>

Securing the process hub to outer arm cover

	Action	Note
1	<p>For robots with protection type Clean Room:</p> <p>Clean the joints that have been opened and wipe the parts free from particles with spirit on a lint free. See Cut the paint or surface on the robot before replacing parts on page 118</p> <p> Note</p> <p>After all repair work, wipe the Clean Room robot free from particles with spirit on a lint free cloth.</p>	
2	Insert the process hub from the outer arm cover.	

Continues on next page

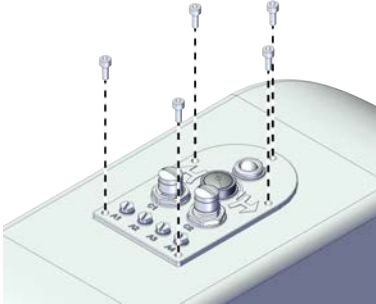
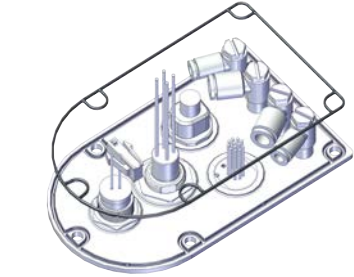
	Action	Note
3	<p>Secure the process hub to the outer arm cover with the screws.</p> <p> Note</p> <p>For robots with protection class IP54 (option 3350-540)</p> <p>For robots with protection type Clean Room (option 3351-1)</p> <p>Check the gasket for the process hub.</p> <p> Tip</p> <p>Replace the gasket if needed.</p> <p> CAUTION</p> <p>Be aware of the cabling that is attached to the cover! The cover can not be removed completely until the connectors are disconnected, as shown in following steps.</p>	<p>Screws: Hex socket head cap screw M4x10 12.9 Lafre 2C2B/FC6.9 (5 pcs)</p> <p>Tightening torque: 2.6 Nm±10%</p> <p>For robots with protection class IP30 (option 3350-300)</p>  <p>xx2100000932</p> <p>For robots with protection class IP54 (option 3350-540)</p> <p>For robots with protection type Clean Room (option 3351-1)</p>  <p>xx2100002438</p>

Concluding procedure

	Action	Note
1	<p>For robots with protection type Clean Room: Seal and paint the joints that have been opened. See Cut the paint or surface on the robot before replacing parts on page 118</p> <p> Note</p> <p>After all repair work, wipe the Clean Room robot free from particles with spirit on a lint free cloth.</p>	
2	Recalibrate the robot.	Calibration is detailed in section Calibration on page 945 .

Continues on next page

5 Repair

5.3.2 Replacing the process hub

Continued

	Action	Note
3	 DANGER Make sure all safety requirements are met when performing the first test run.	

5.3.3 Replacing the SMB unit and battery unit

Location of the SMB unit and battery unit

The SMB unit and battery unit are located as shown in the figure.

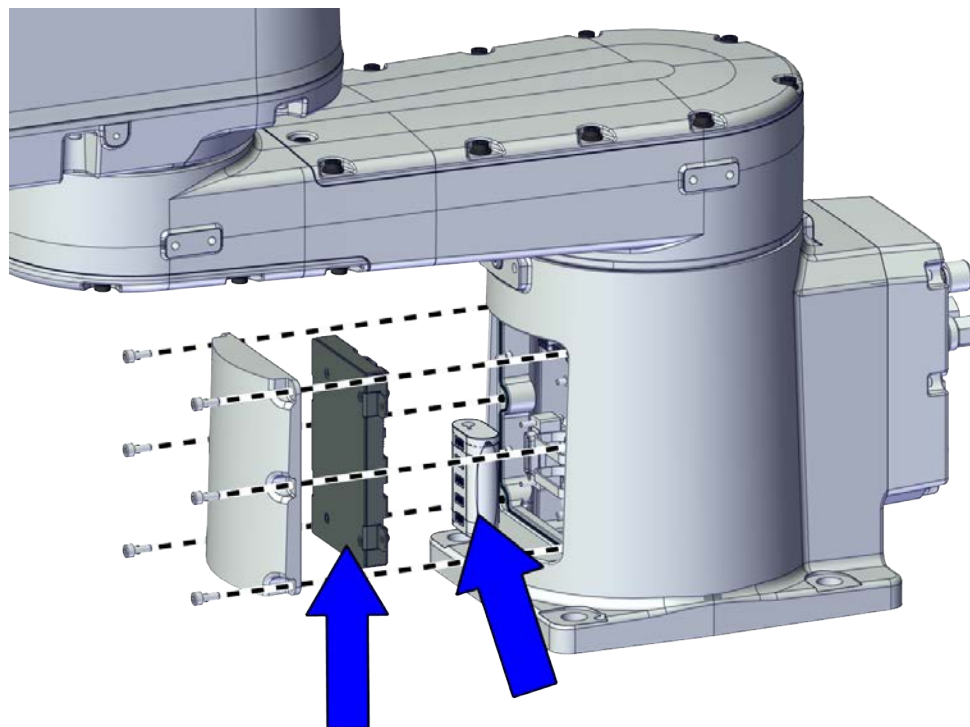

xx2100001010

Required spare parts



Note

The spare part numbers that are listed in the table can be out of date. See the latest spare parts of the IRB 920 via myABB Business Portal, www.abb.com/myABB.

Spare part	Article number	Note
SMB unit	3HAC063968-001	
Battery unit	3HAC044075-001	Battery includes protection circuits. Only replace with a specified spare part or an ABB-approved equivalent.
SMB cover	3HAC076603-001	
Stainless Screw Hexagon Socket Head Cap, Clean Room	3HAC075438-001	Used with protection type Clean Room.
Gasket, SMB cover	3HAC073938-001	Used with protection type Clean Room.

Continues on next page

5 Repair

5.3.3 Replacing the SMB unit and battery unit

Continued

Required tools and equipment

Equipment	Article number	Note
Standard toolkit	-	Content is defined in section Standard toolkit on page 996 .
Calibration toolbox, Axis Calibration	3HAC055412-001	Delivered as a set of calibration tools. Required if Axis Calibration is the valid calibration method for the robot.

Required consumables

Consumable	Article number	Note
Cable straps	-	

Deciding calibration routine

Decide which calibration routine to be used, based on the information in the table. Depending on which routine is chosen, action might be required prior to beginning the repair work of the robot, see the table.

	Action	Note
1	Decide which calibration routine to use for calibrating the robot. <ul style="list-style-type: none">Reference calibration. External cable packages (DressPack) and tools can stay fitted on the robot.Fine calibration. All external cable packages (DressPack) and tools must be removed from the robot.	
	If the robot is to be calibrated with reference calibration: Find previous reference values for the axis or create new reference values. These values are to be used after the repair procedure is completed, for calibration of the robot. If no previous reference values exist, and no new reference values can be created, then reference calibration is not possible.	Follow the instructions given in the reference calibration routine on the FlexPendant to create reference values. Creating new values requires possibility to move the robot. Read more about reference calibration for Axis Calibration in Reference calibration routine on page 957 .
	If the robot is to be calibrated with fine calibration: Remove all external cable packages (DressPack) and tools from the robot.	



Removing the SMB unit and battery unit

Use these procedures to remove the SMB unit and battery unit.

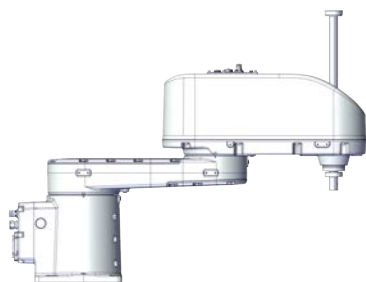

Preparations before removing the SMB unit and battery unit

	Action	Note
1	Decide which calibration routine to use, and take actions accordingly prior to beginning the repair procedure.	

Continues on next page

	Action	Note
2	Jog all axes to zero position.	 xx2100000930
3	 DANGER Turn off all: <ul style="list-style-type: none"> • electric power supply • hydraulic pressure supply • air pressure supply to the robot, before entering the safeguarded space.	
4	 CAUTION For robots with protection type Clean Room Always cut the paint with a knife and grind the paint edge when disassembling parts of the robot! See Cut the paint or surface on the robot before replacing parts on page 118 .	

Removing the SMB cover



	Action	Note
1	 DANGER Make sure that all supplies for electrical power, hydraulic pressure, and air pressure are turned off.	
2	 ELECTROSTATIC DISCHARGE (ESD) The unit is sensitive to ESD. Before handling the unit read the safety information in section The unit is sensitive to ESD on page 49 .	
3	 CAUTION For robots with protection type Clean Room Always cut the paint with a knife and grind the paint edge when disassembling parts of the robot! See Cut the paint or surface on the robot before replacing parts on page 118 .	

Continues on next page

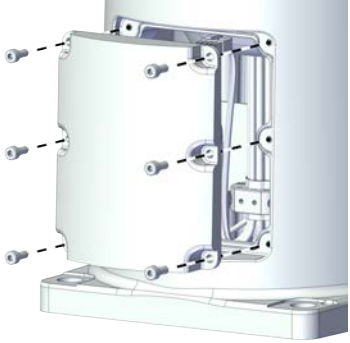

5 Repair

5.3.3 Replacing the SMB unit and battery unit

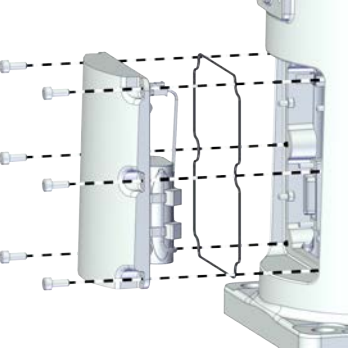

Continued

	Action	Note
4	<p>Remove the screws on the SMB cover to the base.</p> <p> Note</p> <p>For robots with protection type Clean Room (option 3351-1) Remove the stainless screws on the SMB cover to the base.</p>	<p>For robots with protection class IP30 (option 3350-300)</p> 
5	<p>Pull the SMB cover with the SMB unit assembly out together.</p> <p> Note</p> <p>For robots with protection class IP54 (option 3350-540) For robots with protection type Clean Room (option 3351-1) Check the gasket for the SMB cover.</p> <p> Tip</p> <p>Replace the gasket if needed.</p>	<p>xx2100000944</p> <p>For robots with protection class IP54 (option 3350-540) For robots with protection type Clean Room (option 3351-1)</p>  <p>xx2100002433</p>



Disconnecting the SMB cabling

	Action	Note
1	<p> DANGER</p> <p>Make sure that all supplies for electrical power, hydraulic pressure, and air pressure are turned off.</p>	
2	<p> ELECTROSTATIC DISCHARGE (ESD)</p> <p>The unit is sensitive to ESD. Before handling the unit read the safety information in section The unit is sensitive to ESD on page 49.</p>	

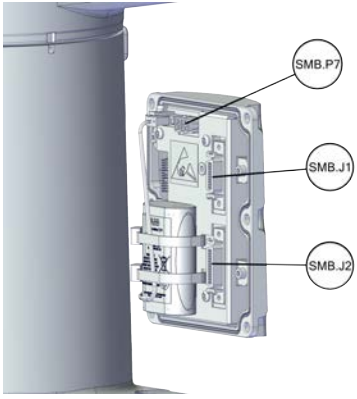
Continues on next page

	Action	Note
3	<p> CAUTION</p> <p>For robots with protection type Clean Room Always cut the paint with a knife and grind the paint edge when disassembling parts of the robot! See Cut the paint or surface on the robot before replacing parts on page 118.</p>	
4	Cut the strips.	
5	<p>Disconnect the connectors.</p> <ul style="list-style-type: none"> • SMB.P7 • SMB.J1 • SMB.J2 <p> Tip</p> <p>Take photos of the connector and cable position before disconnecting them, to have as a reference when reconnecting.</p>	 <p>xx2100000945</p>

Removing the SMB unit

	Action	Note
1	<p> DANGER</p> <p>Make sure that all supplies for electrical power, hydraulic pressure, and air pressure are turned off.</p>	
2	<p> ELECTROSTATIC DISCHARGE (ESD)</p> <p>The unit is sensitive to ESD. Before handling the unit read the safety information in section The unit is sensitive to ESD on page 49.</p>	
3	<p> CAUTION</p> <p>For robots with protection type Clean Room Always cut the paint with a knife and grind the paint edge when disassembling parts of the robot! See Cut the paint or surface on the robot before replacing parts on page 118.</p>	

Continues on next page



5 Repair

5.3.3 Replacing the SMB unit and battery unit

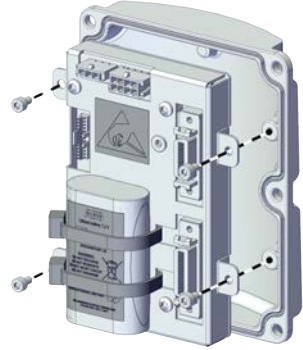
Continued

	Action	Note
4	Remove the SMB package attachment screws and remove the SMB package from the SMB cover.	 xx2100001036

Separating the battery unit and SMB unit

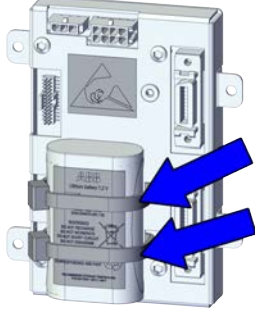

	Action	Note
1	 DANGER Make sure that all supplies for electrical power, hydraulic pressure, and air pressure are turned off.	
2	 ELECTROSTATIC DISCHARGE (ESD) The unit is sensitive to ESD. Before handling the unit read the safety information in section The unit is sensitive to ESD on page 49 .	
3	 CAUTION For robots with protection type Clean Room Always cut the paint with a knife and grind the paint edge when disassembling parts of the robot! See Cut the paint or surface on the robot before replacing parts on page 118 .	
4	Separate the battery unit from the SMB assembly by cutting the cable straps.	 xx2100001035

Continues on next page

Refitting the SMB unit and battery unit

Use these procedures to refit the SMB unit and battery unit.

Refitting the SMB unit and battery unit

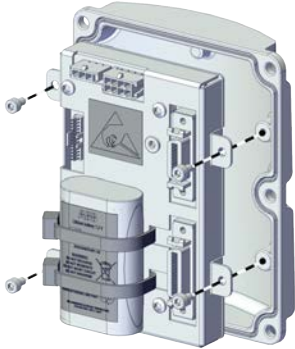
	Action	Note
1	 <p>ELECTROSTATIC DISCHARGE (ESD)</p> <p>The unit is sensitive to ESD. Before handling the unit read the safety information in section The unit is sensitive to ESD on page 49.</p>	
2	<p>For robots with protection type Clean Room: Clean the joints that have been opened and wipe the parts free from particles with spirit on a lint free. See Cut the paint or surface on the robot before replacing parts on page 118</p> <p> Note</p> <p>After all repair work, wipe the Clean Room robot free from particles with spirit on a lint free cloth.</p>	
3	<p>Bind the SMB unit to the battery unit with the cable strap.</p>	 <p>xx2100001035</p>
4	<p>Refit the SMB package to the SMB cover with the screws.</p>	<p>Screws: Hex socket head cap screw M3x5 12.9 Lafre 2C2B/FC6.9 (4 pcs) Tightening torque: 0.8 Nm</p>  <p>xx2100001036</p>

Continues on next page



5 Repair

5.3.3 Replacing the SMB unit and battery unit



Continued

	Action	Note
5	<p>Route and secure the cabling with cable straps if needed.</p> <p> CAUTION</p> <p>Correct cable routing is highly important. If the cables are routed and secured incorrectly the cables can be damaged.</p>	

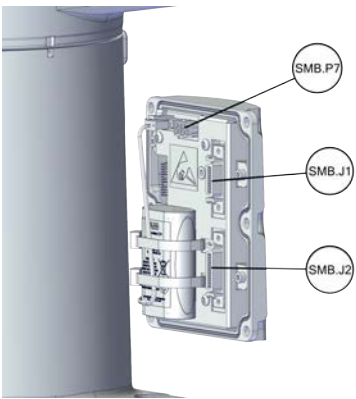
Refitting the SMB cover

	Action	Note
1	<p>For robots with protection type Clean Room: Clean the joints that have been opened and wipe the parts free from particles with spirit on a lint free. See Cut the paint or surface on the robot before replacing parts on page 118</p> <p> Note</p> <p>After all repair work, wipe the Clean Room robot free from particles with spirit on a lint free cloth.</p>	
2	<p>Reconnect the connectors.</p> <ul style="list-style-type: none"> • SMB.P7 • SMB.J1 • SMB.J2 <p> Tip</p> <p>Take photos of the connector and cable position before disconnecting them, to have as a reference when reconnecting.</p>	 <p>xx2100000945</p>

Continues on next page

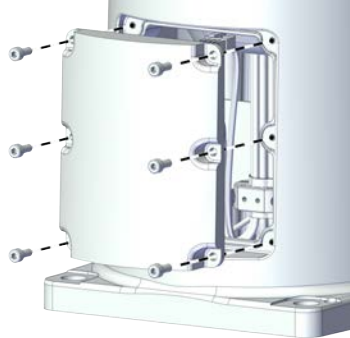
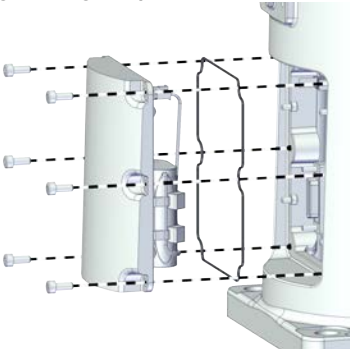
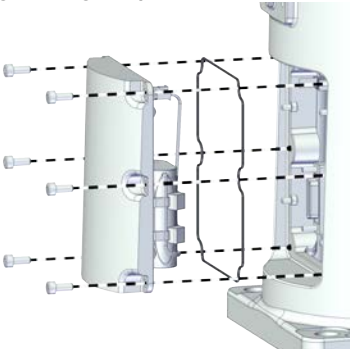
	Action	Note
3	<p>Refit the SMB cover assembly.</p> <p> Note</p> <p>For robots with protection class IP54 (option 3350-540)</p> <p>For robots with protection type Clean Room (option 3351-1)</p> <p>Check the gasket for the SMB cover.</p> <p> Tip</p> <p>Replace the gasket if needed.</p>	<p>For robots with protection class IP30 (option 3350-300)</p> <p>Screws: Hex socket head cap screw M4x10 12.9 Lafre 2C2B/FC6.9 (6 pcs)</p> <p>Tightening torque: 2.6 Nm</p> 
4	<p>Secure the SMB cover to the base with the screws.</p>	<p>xx210000944</p> <p>For robots with protection type Clean Room (option 3351-1)</p> <p>Screws: Stainless Screw Hexagon Socket Head Cap, Clean Room 3HAC075438-001 (6 pcs)</p> <p>Tightening torque: 2.6 Nm</p>  <p>xx2100002433</p> <p>For robots with protection class IP54 (option 3350-540)</p> <p>Screws: Hex socket head cap screw M4x10 12.9 Lafre 2C2B/FC6.9 (6 pcs)</p> <p>Tightening torque: 2.6 Nm</p>  <p>xx2100002433</p>



Continues on next page

5 Repair

5.3.3 Replacing the SMB unit and battery unit

Continued

Concluding procedure

	Action	Note
1	<p>For robots with protection type Clean Room: Seal and paint the joints that have been opened. See Cut the paint or surface on the robot before replacing parts on page 118</p> <p> Note</p> <p>After all repair work, wipe the Clean Room robot free from particles with spirit on a lint free cloth.</p>	
2	Recalibrate the robot.	Calibration is detailed in section Calibration on page 945 .
3	<p> DANGER</p> <p>Make sure all safety requirements are met when performing the first test run.</p>	

5.4 Base

5.4.1 Replacing the base

Location of the base

The base is located as shown in the figure.

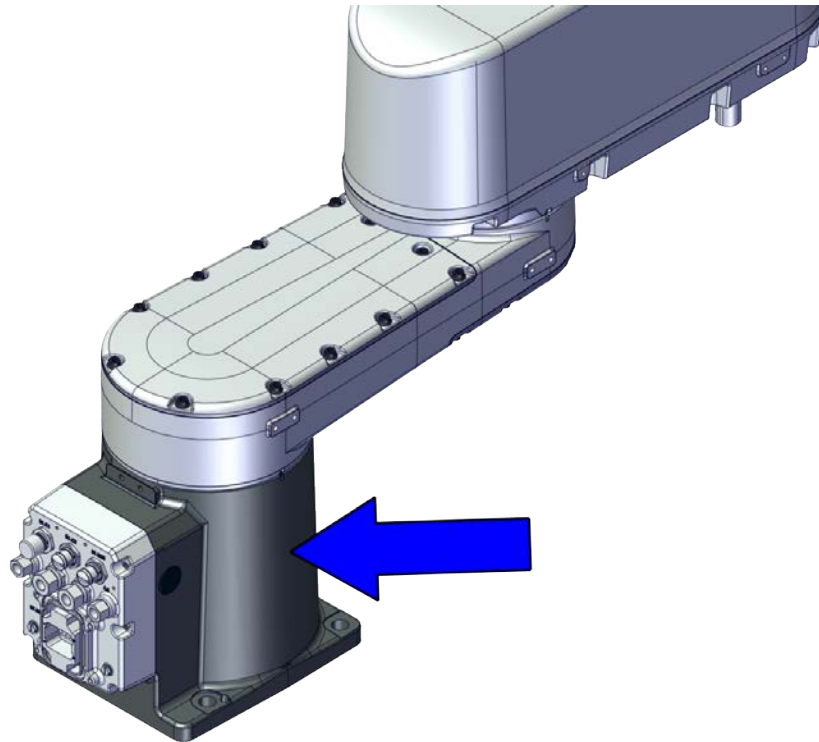

xx2100001011

Required spare parts



Note

The spare part numbers that are listed in the table can be out of date. See the latest spare parts of the IRB 920 via myABB Business Portal, www.abb.com/myABB.

Spare part	Article number	Note
Base	3HAC076568-001	
Base plate, rear outlet cable	3HAC067865-001	Base bottom cover, rear cable
Rear plate	3HAC070312-001	Base rear cover, bottom cable
Base plate, underneath outlet cable	3HAC067864-001	Base bottom cover, bottom cable
Block	3HAC075320-001	
Gasket, bottom plate	3HAC073939-001	Base rear cover, bottom cable

Continues on next page

5 Repair

5.4.1 Replacing the base

Continued

Spare part	Article number	Note
Gasket, Foot cover	3HAC065350-001	When using with UndeneathOutletCable, this gasket will be used in rear plate and base plate.
Air exhaust	3HAC082080-001	Used with protection type Clean Room.

Required tools and equipment

Equipment	Article number	Note
Standard toolkit	-	Content is defined in section Standard toolkit on page 996 .
Calibration toolbox, Axis Calibration	3HAC055412-001	Delivered as a set of calibration tools. Required if Axis Calibration is the valid calibration method for the robot.
Sonic tension meter	-	Used for measuring the timing belt tension.
Handheld dynamometer	-	Used for measuring the timing belt tension.

Required consumables

Consumable	Article number	Note
Cable straps	-	
Grease	3HAC029132-001	FM 222

Deciding calibration routine

Decide which calibration routine to be used, based on the information in the table. Depending on which routine is chosen, action might be required prior to beginning the repair work of the robot, see the table.

	Action	Note
1	Decide which calibration routine to use for calibrating the robot. <ul style="list-style-type: none">Reference calibration. External cable packages (DressPack) and tools can stay fitted on the robot.Fine calibration. All external cable packages (DressPack) and tools must be removed from the robot.	
	If the robot is to be calibrated with reference calibration: Find previous reference values for the axis or create new reference values. These values are to be used after the repair procedure is completed, for calibration of the robot. If no previous reference values exist, and no new reference values can be created, then reference calibration is not possible.	Follow the instructions given in the reference calibration routine on the FlexPendant to create reference values. Creating new values requires possibility to move the robot. Read more about reference calibration for Axis Calibration in Reference calibration routine on page 957 .



Continues on next page

Action	Note
<p>If the robot is to be calibrated with fine calibration: Remove all external cable packages (DressPack) and tools from the robot.</p>	

Removing the base

Use these procedures to remove the base.

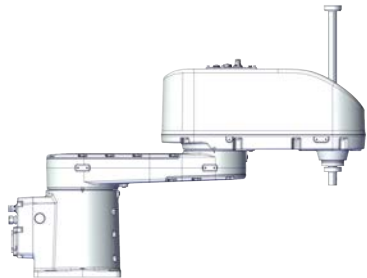
Preparations before removing the base

	Action	Note
1	Decide which calibration routine to use, and take actions accordingly prior to beginning the repair procedure.	
2	<p>If there is no enough space for the maintenance work, remove the robot from the wall and place it on the maintenance bracket.</p> <p> CAUTION</p> <p>Do not lay down the robot during the transportation, always keep it straight. If the robot lay down in any situation, the grease may come out from gearbox.</p>	
3	Jog all axes to zero position.	 <p>xx2100000930</p>
4	<p> DANGER</p> <p>Turn off all:</p> <ul style="list-style-type: none"> • electric power supply • hydraulic pressure supply • air pressure supply <p>to the robot, before entering the safeguarded space.</p>	
5	<p> CAUTION</p> <p>For robots with protection type Clean Room Always cut the paint with a knife and grind the paint edge when disassembling parts of the robot! See Cut the paint or surface on the robot before replacing parts on page 118.</p>	





Continues on next page

5 Repair

5.4.1 Replacing the base

Continued



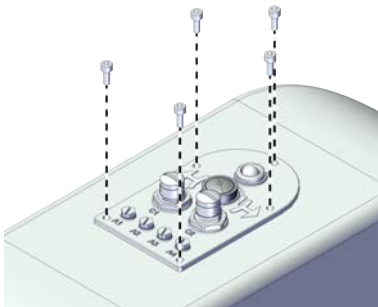
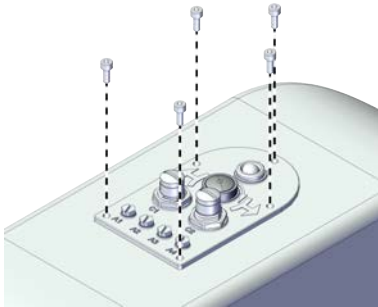

Removing the process hub screws

	Action	Note
1	 DANGER Make sure that all supplies for electrical power, hydraulic pressure, and air pressure are turned off.	
2	 CAUTION For robots with protection type Clean Room Always cut the paint with a knife and grind the paint edge when disassembling parts of the robot! See Cut the paint or surface on the robot before replacing parts on page 118 .	
3	Remove the screws on the process hub.  Note For robots with protection class IP54 (option 3350-540) For robots with protection type Clean Room (option 3351-1) Remove the screws on the process hub and take out the gasket.  Tip Check the gasket and replace it if needed.	For robots with protection class IP30  <small>xx2100000932</small> For robots with protection class IP54 (option 3350-540) For robots with protection type Clean Room (option 3351-1)  <small>xx2100000932</small>
4	Insert the process hub to the outer arm.	

Continues on next page

For Clean Room/ IP54 robots

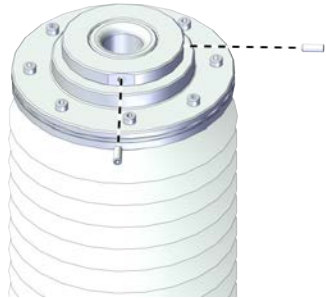
Removing the top cover and the flange with bearing

	Action	Note
1	 DANGER Make sure that all supplies for electrical power, hydraulic pressure, and air pressure are turned off.	
2	 CAUTION For robots with protection type Clean Room Always cut the paint with a knife and grind the paint edge when disassembling parts of the robot! See Cut the paint or surface on the robot before replacing parts on page 118 .	
3	For robots with protection class IP54 (option 3350-540) For robots with protection type Clean Room (option 3351-1) Loose the locking screws.	 xx2100002398
4	For robots with protection class IP54 (option 3350-540) For robots with protection type Clean Room (option 3351-1) Remove the top cover from the ball screw.	 xx2100002399

Continues on next page



5 Repair

5.4.1 Replacing the base

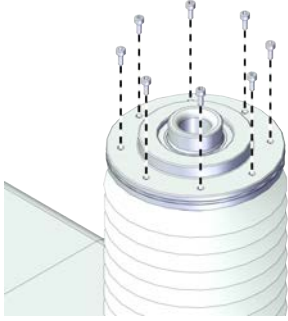
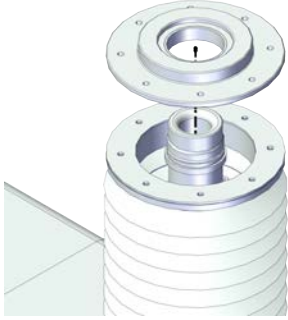

Continued

	Action	Note
5	<p>For robots with protection class IP54 (option 3350-540)</p> <p>For robots with protection type Clean Room (option 3351-1)</p> <p>Remove the screws on the flange with bearing.</p>	 <p>xx2100002401</p>
6	<p>For robots with protection class IP54 (option 3350-540)</p> <p>For robots with protection type Clean Room (option 3351-1)</p> <p>Remove the flange with bearing.</p>	 <p>xx2100002402</p>



Removing the cover of the outer arm

	Action	Note
1	 <p>DANGER</p> <p>Make sure that all supplies for electrical power, hydraulic pressure, and air pressure are turned off.</p>	
2	 <p>CAUTION</p> <p>For robots with protection type Clean Room</p> <p>Always cut the paint with a knife and grind the paint edge when disassembling parts of the robot! See Cut the paint or surface on the robot before replacing parts on page 118.</p>	

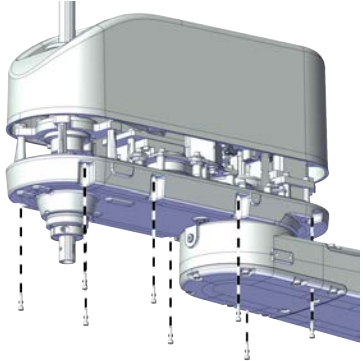
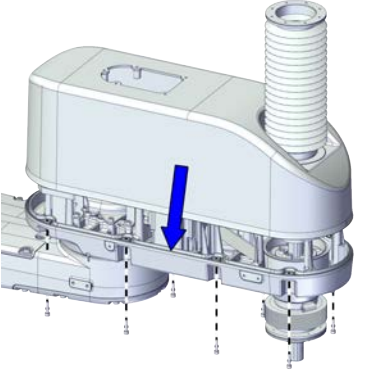
Continues on next page

	Action	Note
3	<p>Remove the screws on the cover of the outer arm and remove the cover.</p> <p> Note</p> <p>For robots with protection class IP54 (option 3350-540) For robots with protection type Clean Room (option 3351-1) Remove the cover with bellow and housing.</p> <p> Note</p> <p>The bellow does not need to be removed separately.</p> <p> Tip</p> <p>Check the gasket and replace it if needed.</p>	<p>For robots with protection class IP30</p>  <p>xx2100000933</p> <p>For robots with protection class IP54 (option 3350-540) For robots with protection type Clean Room (option 3351-1)</p>  <p>xx2100002427</p>

Disconnecting the air hoses, C1 cabling and C2 cabling (if equipped)





	Action	Note
1	<p> DANGER</p> <p>Make sure that all supplies for electrical power, hydraulic pressure, and air pressure are turned off.</p>	
2	<p> CAUTION</p> <p>For robots with protection type Clean Room Always cut the paint with a knife and grind the paint edge when disassembling parts of the robot! See Cut the paint or surface on the robot before replacing parts on page 118.</p>	

Continues on next page

5 Repair

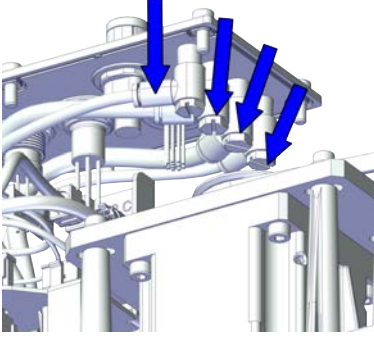
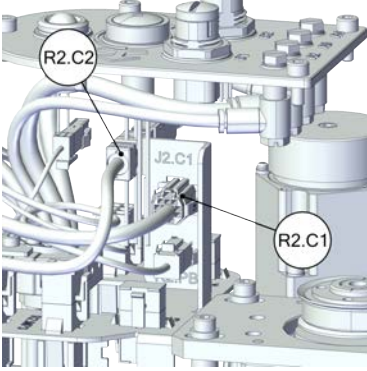
5.4.1 Replacing the base

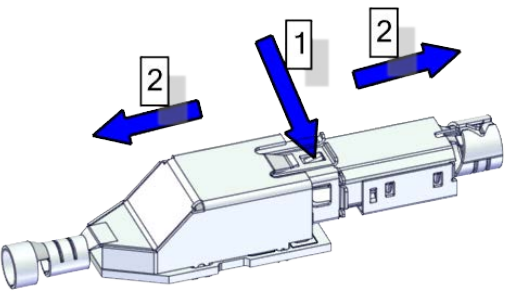
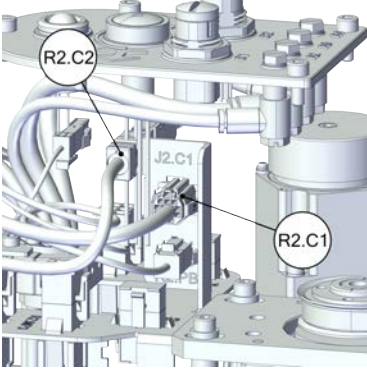

Continued

	Action	Note
3	<p>Disconnect the air hoses from the L-shaped connectors.</p>	 <p>xx2100001032</p>
4	<p>For robots with C1 cabling Disconnect the connector.</p> <ul style="list-style-type: none"> • R2.C1 	 <p>xx2100001033</p>
5	<p>For robots with C2 cabling Disconnect the connector.</p> <ul style="list-style-type: none"> • R1.C2 <p> Tip</p> <p>Cut the cable straps for the R1.C2 at the same time.</p> <p> Tip</p> <p>Take photos of the connector and cable position before disconnecting them, to have as a reference when reconnecting.</p> <p> Tip</p> <p>The connector clip has to be pressed (1) and pushed forward (2) to separate the R1.C2 (for C2 cabling).</p>  <p>xx1800002943</p>	 <p>xx2100001033</p>

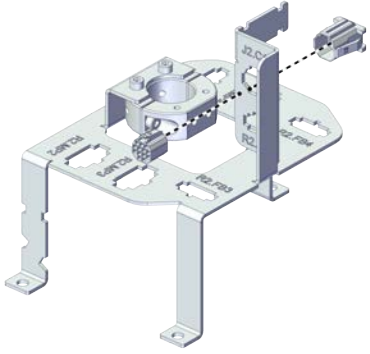
Continues on next page

	Action	Note
6	<p>Snap loose and remove the female head of the connectors from the bracket.</p> <p> Note</p> <p>The harness are not visible due to the cleanness requirements of the illustration. They are still existing inside the cable ferrule in the actual situation.</p>	 <p>xx2100001034</p>

Disconnecting the connectors for axis-2 motor

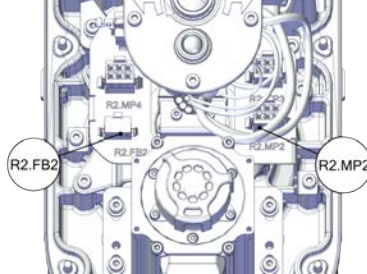
	Action	Note
1	<p> DANGER</p> <p>Make sure that all supplies for electrical power, hydraulic pressure, and air pressure are turned off.</p>	
2	<p> CAUTION</p> <p>For robots with protection type Clean Room Always cut the paint with a knife and grind the paint edge when disassembling parts of the robot! See Cut the paint or surface on the robot before replacing parts on page 118.</p>	
3	<p>Disconnect the connectors.</p> <ul style="list-style-type: none"> • R2.MP2 • R2.FB2 	 <p>xx2100000934</p>

Continues on next page



5 Repair

5.4.1 Replacing the base

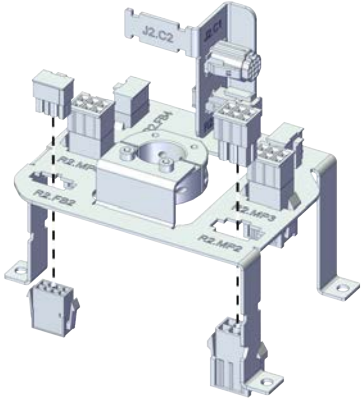
Continued

	Action	Note
4	<p>Snap loose and remove the female head of the connectors from the bracket.</p> <p> Note</p> <p>The harness are not visible due to the cleanness requirements of the illustration. They are still existing inside the cable ferrule in the actual situation.</p>	 <p>xx2100000935</p>

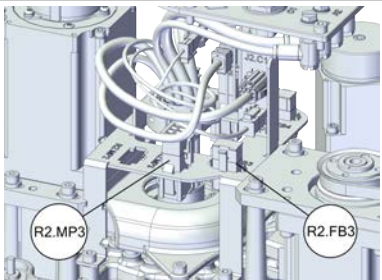

Disconnecting the connectors for axis-3 motor

	Action	Note
1	<p> DANGER</p> <p>Make sure that all supplies for electrical power, hydraulic pressure, and air pressure are turned off.</p>	
2	<p> CAUTION</p> <p>For robots with protection type Clean Room</p> <p>Always cut the paint with a knife and grind the paint edge when disassembling parts of the robot!</p> <p>See Cut the paint or surface on the robot before replacing parts on page 118.</p>	
3	<p>Disconnect the connectors.</p> <ul style="list-style-type: none"> • R2.MP3 • R2.FB3 	 <p>xx2100000936</p>

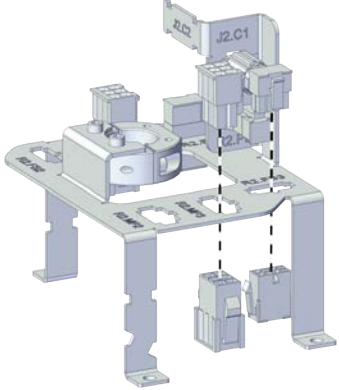
Continues on next page

	Action	Note
4	<p>Snap loose and remove the female head of the connectors from the bracket.</p> <p> Note</p> <p>The harness are not visible due to the cleanness requirements of the illustration. They are still existing inside the cable ferrule in the actual situation.</p>	 <p>xx2100000937</p>

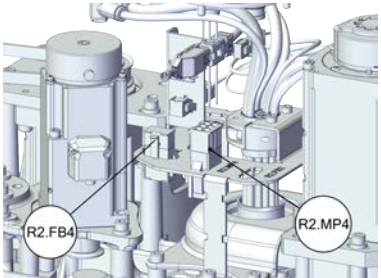
Disconnecting the connectors for axis-4 motor

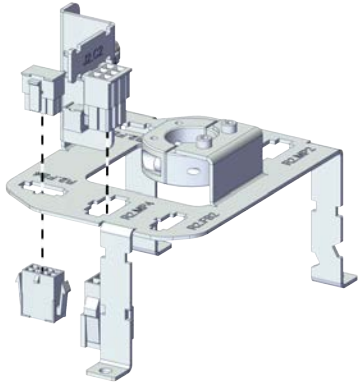
	Action	Note
1	<p>For robots with protection type Clean Room: Clean the joints that have been opened and wipe the parts free from particles with spirit on a lint free. See Cut the paint or surface on the robot before replacing parts on page 118</p> <p> Note</p> <p>After all repair work, wipe the Clean Room robot free from particles with spirit on a lint free cloth.</p>	
2	<p>Disconnect the axis-4 motor connectors.</p> <ul style="list-style-type: none"> • R2.MP4 • R2.FB4 	 <p>xx2100000938</p>
3	<p>Snap loose and remove the female head of the connectors from the bracket.</p> <p> Note</p> <p>The harness are not visible due to the cleanness requirements of the illustration. They are still existing inside the cable ferrule in the actual situation.</p>	 <p>xx2100000939</p>





Continues on next page

5 Repair

5.4.1 Replacing the base

Continued

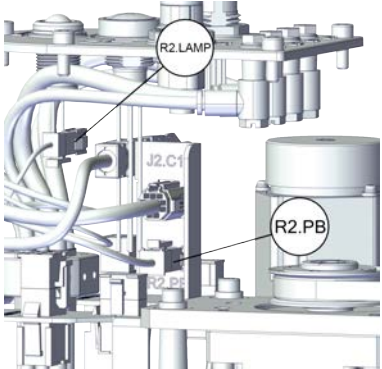

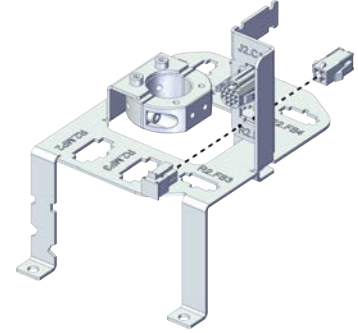

Disconnecting the connector for PB

	Action	Note
1	 DANGER Make sure that all supplies for electrical power, hydraulic pressure, and air pressure are turned off.	
2	 CAUTION For robots with protection type Clean Room Always cut the paint with a knife and grind the paint edge when disassembling parts of the robot! See Cut the paint or surface on the robot before replacing parts on page 118 .	
3	Disconnect the connector. <ul style="list-style-type: none"> • R2.PB • R2.LAMP 	 <p>xx2100001030</p>
4	Snap loose and remove the female head of the connector from the bracket.  Note The harness are not visible due to the cleanliness requirements of the illustration. They are still existing inside the cable ferrule in the actual situation.	 <p>xx2100001031</p>



Pull out the process hub

	Action	Note
1	 DANGER Make sure that all supplies for electrical power, hydraulic pressure, and air pressure are turned off.	

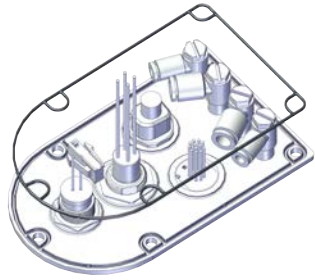
Continues on next page

	Action	Note
2	 CAUTION For robots with protection type Clean Room Always cut the paint with a knife and grind the paint edge when disassembling parts of the robot! See <i>Cut the paint or surface on the robot before replacing parts on page 118.</i>	
3	Take out the process hub.  Note For robots with protection class IP54 (option 3350-540) For robots with protection type Clean Room (option 3351-1) Check the gasket for the process hub.  Tip Replace the gasket if needed.  CAUTION Be aware of the cabling that is attached to the cover! The cover can not be removed completely until the connectors are disconnected, as shown in following steps.	For robots with protection class IP54 (option 3350-540) For robots with protection type Clean Room (option 3351-1)  xx2100002438

Removing the cable ferrule and bracket



	Action	Note
1	 DANGER Make sure that all supplies for electrical power, hydraulic pressure, and air pressure are turned off.	
2	 CAUTION For robots with protection type Clean Room Always cut the paint with a knife and grind the paint edge when disassembling parts of the robot! See <i>Cut the paint or surface on the robot before replacing parts on page 118.</i>	

Continues on next page

5 Repair

5.4.1 Replacing the base

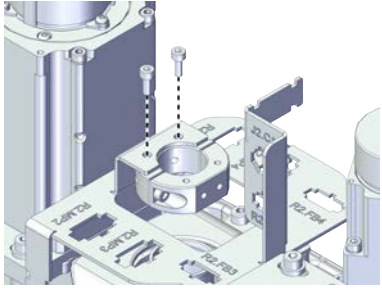

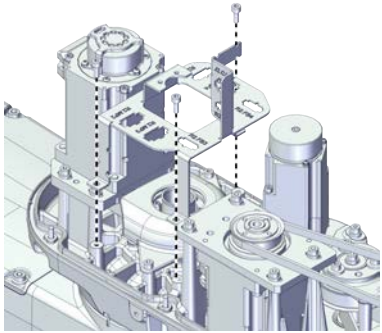
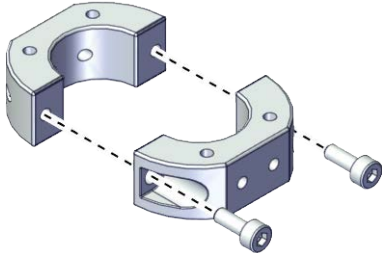
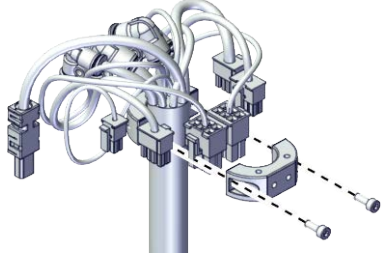
Continued

	Action	Note
3	<p>Remove the screws on the bracket to the cable ferrule to release the cable ferrule with cable.</p> <p> Note</p> <p>The harness are not visible due to the cleanness requirements of the illustration. They are still existing inside the cable ferrule in the actual situation.</p>	 <p>xx210000940</p>
4	<p>Remove the screws on the bracket.</p> <p> Note</p> <p>The harness are not visible due to the cleanness requirements of the illustration. They are still existing inside the cable ferrule in the actual situation.</p>	 <p>xx210000941</p>
5	<p>Remove the screws on the cable ferrule and take the cable ferrule out.</p>	 <p>xx1800002842</p>  <p>xx1800002849</p>



Removing the axis-1 cover

	Action	Note
1	<p> DANGER</p> <p>Make sure that all supplies for electrical power, hydraulic pressure, and air pressure are turned off.</p>	

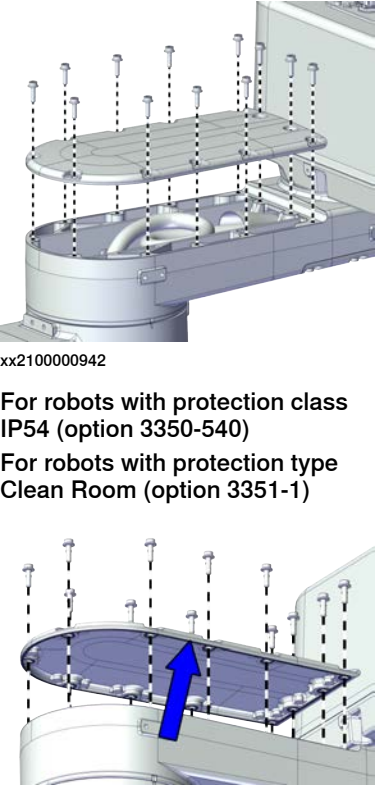
Continues on next page

	Action	Note
2	 CAUTION For robots with protection type Clean Room Always cut the paint with a knife and grind the paint edge when disassembling parts of the robot! See <i>Cut the paint or surface on the robot before replacing parts on page 118.</i>	
3	Remove the screws.	For robots with protection class IP30 (option 3350-300)
4	Remove the cover.  Note For robots with protection class IP54 (option 3350-540) For robots with protection type Clean Room (option 3351-1) Remove the cover and check the gasket.  Tip Replace the gasket if needed.	 <p>xx2100000942</p> <p>For robots with protection class IP54 (option 3350-540) For robots with protection type Clean Room (option 3351-1)</p> <p>xx2100002428</p>

Removing the axis-2 cover



	Action	Note
1	 DANGER Make sure that all supplies for electrical power, hydraulic pressure, and air pressure are turned off.	
2	 CAUTION For robots with protection type Clean Room Always cut the paint with a knife and grind the paint edge when disassembling parts of the robot! See <i>Cut the paint or surface on the robot before replacing parts on page 118.</i>	

Continues on next page



5 Repair

5.4.1 Replacing the base

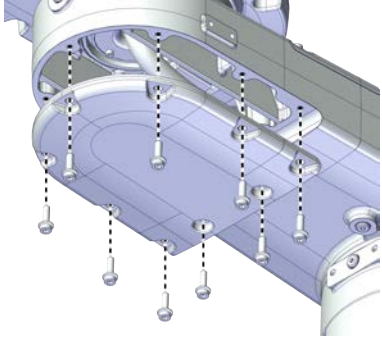
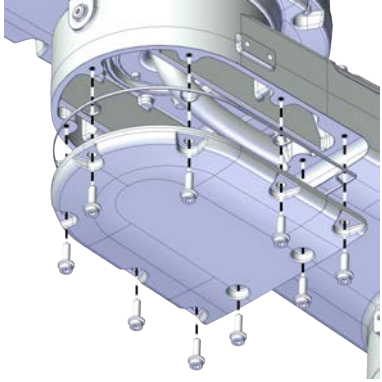



Continued

	Action	Note
3	Remove the screws.	For robots with protection class IP30 (option 3350-300)
4	Remove the cover.  Note For robots with protection class IP54 (option 3350-540) For robots with protection type Clean Room (option 3351-1) Remove the cover and check the gasket.  Tip Replace the gasket if needed.	 xx2100000943 For robots with protection class IP54 (option 3350-540) For robots with protection type Clean Room (option 3351-1)  xx2100002451

Removing the SMB cover

	Action	Note
1	 DANGER Make sure that all supplies for electrical power, hydraulic pressure, and air pressure are turned off.	
2	 ELECTROSTATIC DISCHARGE (ESD) The unit is sensitive to ESD. Before handling the unit read the safety information in section The unit is sensitive to ESD on page 49 .	

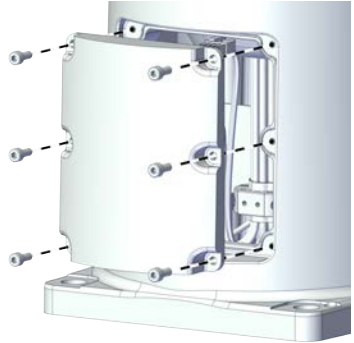
Continues on next page

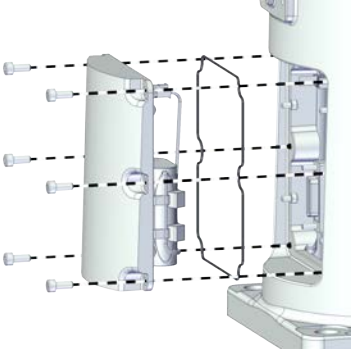
	Action	Note
3	<p> CAUTION</p> <p>For robots with protection type Clean Room Always cut the paint with a knife and grind the paint edge when disassembling parts of the robot! See <i>Cut the paint or surface on the robot before replacing parts on page 118.</i></p>	
4	<p>Remove the screws on the SMB cover to the base.</p> <p> Note</p> <p>For robots with protection type Clean Room (option 3351-1) Remove the stainless screws on the SMB cover to the base.</p>	<p>For robots with protection class IP30 (option 3350-300)</p> 
5	<p>Pull the SMB cover with the SMB unit assembly out together.</p> <p> Note</p> <p>For robots with protection class IP54 (option 3350-540) For robots with protection type Clean Room (option 3351-1) Check the gasket for the SMB cover.</p> <p> Tip</p> <p>Replace the gasket if needed.</p>	<p>xx210000944</p> <p>For robots with protection class IP54 (option 3350-540) For robots with protection type Clean Room (option 3351-1)</p>  <p>xx2100002433</p>

Disconnecting the SMB cabling



	Action	Note
1	<p> DANGER</p> <p>Make sure that all supplies for electrical power, hydraulic pressure, and air pressure are turned off.</p>	

Continues on next page



5 Repair

5.4.1 Replacing the base

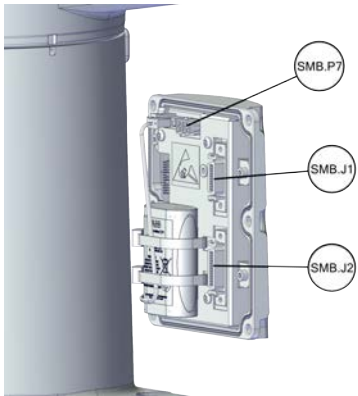

Continued

	Action	Note
2	 ELECTROSTATIC DISCHARGE (ESD) The unit is sensitive to ESD. Before handling the unit read the safety information in section The unit is sensitive to ESD on page 49 .	
3	 CAUTION For robots with protection type Clean Room Always cut the paint with a knife and grind the paint edge when disassembling parts of the robot! See Cut the paint or surface on the robot before replacing parts on page 118 .	
4	Cut the strips.	
5	Disconnect the connectors. <ul style="list-style-type: none"> • SMB.P7 • SMB.J1 • SMB.J2  Tip Take photos of the connector and cable position before disconnecting them, to have as a reference when reconnecting.	 <p>xx2100000945</p>

Removing the base plate/ rear plate

	Action	Note
1	 DANGER Make sure that all supplies for electrical power, hydraulic pressure, and air pressure are turned off.	
2	 CAUTION For robots with protection type Clean Room Always cut the paint with a knife and grind the paint edge when disassembling parts of the robot! See Cut the paint or surface on the robot before replacing parts on page 118 .	
3	Remove the screws on the base to the ground.	
4	Lay down the robot.	

Continues on next page

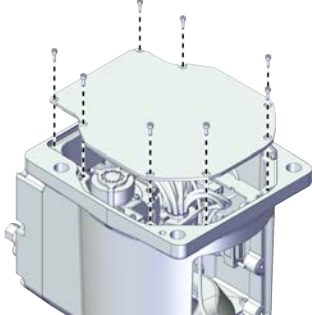
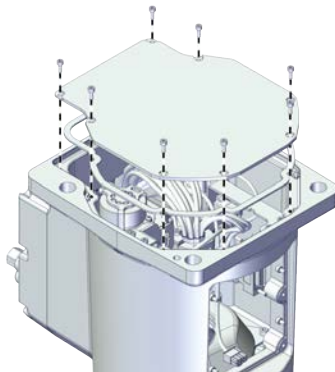

	Action	Note
5	For robot with rear outlet cable version, remove the screws on the base plate.	For rear outlet cable version:
6	<p>Remove the base plate.</p> <p> Note</p> <p>For robots with protection class IP54 (option 3350-540)</p> <p>For robots with protection type Clean Room (option 3351-1)</p> <p>Check the gasket for the base plate.</p> <p> Tip</p> <p>Replace the gasket if needed.</p>	<p>For robots with protection class IP30 (option 3350-300)</p>  <p>xx2100000946</p> <p>For robots with protection class IP54 (option 3350-540)</p> <p>For robots with protection type Clean Room (option 3351-1)</p>  <p>xx2100002434</p>

Continues on next page



5 Repair

5.4.1 Replacing the base

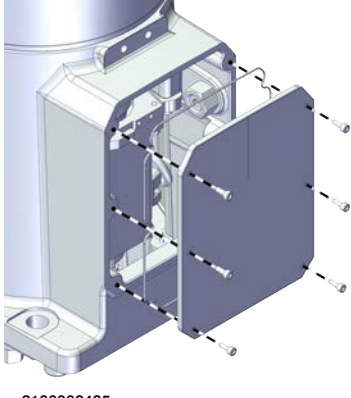
Continued

	Action	Note
7	For robot with underneath outlet cable version, remove the screws on the rear plate.	For underneath outlet cable version: For robots with protection class IP30 (option 3350-300)
8	Remove the rear plate.  Note For robots with protection class IP54 (option 3350-540) For robots with protection type Clean Room (option 3351-1) Check the gasket for the rear plate.  Tip Replace the gasket if needed.	
		 <p>xx2100002435</p>



Disconnecting the grounding cable connectors

	Action	Note
1	 DANGER Make sure that all supplies for electrical power, hydraulic pressure, and air pressure are turned off.	
2	 CAUTION For robots with protection type Clean Room Always cut the paint with a knife and grind the paint edge when disassembling parts of the robot! See Cut the paint or surface on the robot before replacing parts on page 118 .	

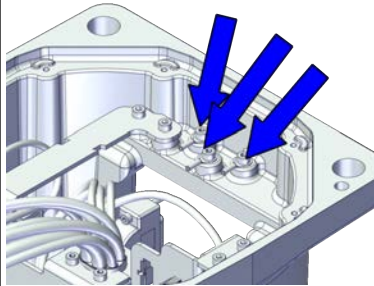
Continues on next page

	Action	Note
3	Remove the three grounding cables from the bracket by unscrew the screws.	 <p>xx2100000947</p>

Releasing the base bracket

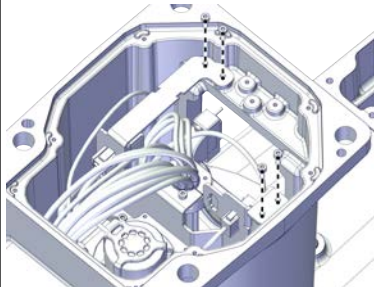
	Action	Note
1	 DANGER Make sure that all supplies for electrical power, hydraulic pressure, and air pressure are turned off.	
2	 CAUTION For robots with protection type Clean Room Always cut the paint with a knife and grind the paint edge when disassembling parts of the robot! See Cut the paint or surface on the robot before replacing parts on page 118 .	
3	Remove the screws on the base bracket to the base.	 <p>xx2100000948</p>



Disconnecting the connectors for axis-1 motor

	Action	Note
1	 DANGER Make sure that all supplies for electrical power, hydraulic pressure, and air pressure are turned off.	

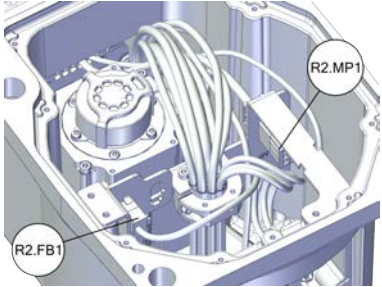

5 Repair

5.4.1 Replacing the base

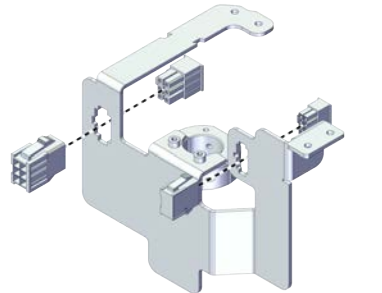
Continued

	Action	Note
2	 CAUTION For robots with protection type Clean Room Always cut the paint with a knife and grind the paint edge when disassembling parts of the robot! See Cut the paint or surface on the robot before replacing parts on page 118 .	
3	Disconnect the connectors. <ul style="list-style-type: none"> • R2.MP1 • R2.FB1 	 <p>xx2100000949</p>
4	Snap loose and remove the female head of the connectors from the bracket.  Note The harness are not visible due to the cleanliness requirements of the illustration. They are still existing inside the cable ferrule in the actual situation.	 <p>xx2100000950</p>



Removing the bracket

	Action	Note
1	 DANGER Make sure that all supplies for electrical power, hydraulic pressure, and air pressure are turned off.	
2	 CAUTION For robots with protection type Clean Room Always cut the paint with a knife and grind the paint edge when disassembling parts of the robot! See Cut the paint or surface on the robot before replacing parts on page 118 .	

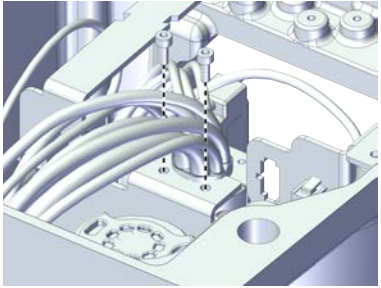
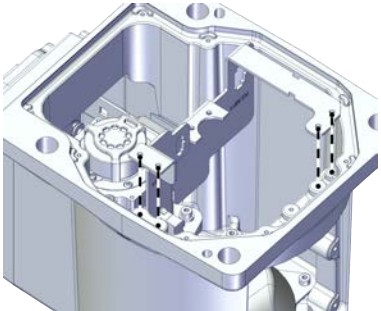
Continues on next page

	Action	Note
3	Release the cable ferrule from the bracket.	 <p>xx2100000951</p>
4	Remove the bracket.	 <p>xx2100000952</p>

Removing the main harness from the axis -2 gearbox position



	Action	Note
1	 <p>DANGER</p> <p>Make sure that all supplies for electrical power, hydraulic pressure, and air pressure are turned off.</p>	
2	 <p>CAUTION</p> <p>For robots with protection type Clean Room Always cut the paint with a knife and grind the paint edge when disassembling parts of the robot! See Cut the paint or surface on the robot before replacing parts on page 118.</p>	

Continues on next page



5 Repair

5.4.1 Replacing the base

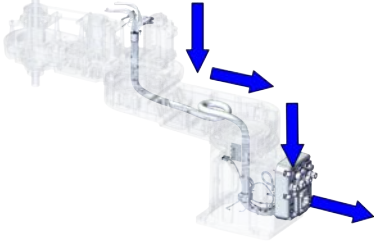
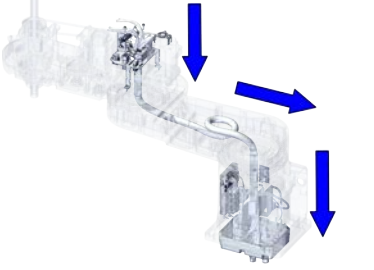
Continued

	Action	Note
3	<p>Pull the internal harness out of the outer arm from the centre of the axis-2 gearbox.</p> <p> Tip</p> <p>Wrap the connectors with the masking tape.</p> <p> Tip</p> <p>Take photos of the connector and cable position before disconnecting them, to have as a reference when reconnecting.</p>	<p>For rear outlet cable version:</p>  <p>xx2100000954</p> <p>For underneath outlet cable version:</p>  <p>xx2100001203</p>



Removing the main harness from the axis -1 gearbox position

	Action	Note
1	<p> DANGER</p> <p>Make sure that all supplies for electrical power, hydraulic pressure, and air pressure are turned off.</p>	
2	<p> CAUTION</p> <p>For robots with protection type Clean Room</p> <p>Always cut the paint with a knife and grind the paint edge when disassembling parts of the robot!</p> <p>See Cut the paint or surface on the robot before replacing parts on page 118.</p>	

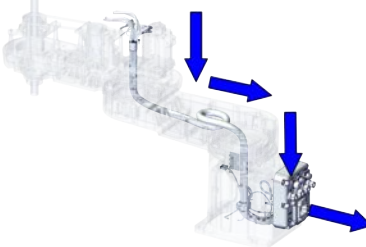
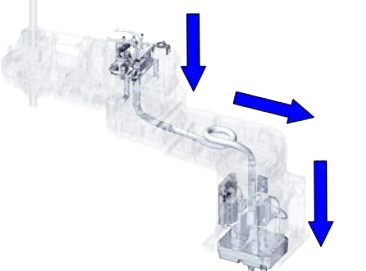
Continues on next page

	Action	Note
3	<p>Pull the internal harness out of the inner arm from the sleeve of the axis-1 gearbox.</p> <p> Tip</p> <p>Wrap the connectors with the masking tape.</p>	<p>For rear outlet cable version:</p>  <p>xx2100000954</p> <p>For underneath outlet cable version:</p>  <p>xx2100001203</p>

Removing the main harness



	Action	Note
1	<p> DANGER</p> <p>Make sure that all supplies for electrical power, hydraulic pressure, and air pressure are turned off.</p>	
2	<p> CAUTION</p> <p>For robots with protection type Clean Room</p> <p>Always cut the paint with a knife and grind the paint edge when disassembling parts of the robot! See Cut the paint or surface on the robot before replacing parts on page 118.</p>	

Continues on next page



5 Repair

5.4.1 Replacing the base

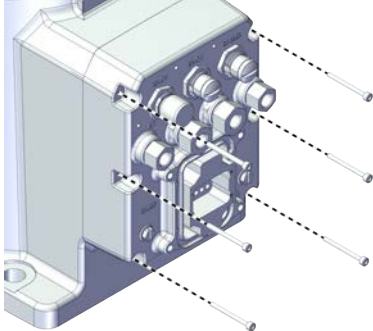
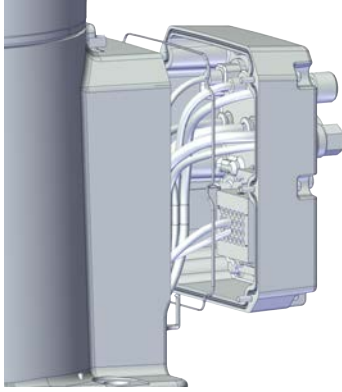
Continued

	Action	Note
3	For robot with rear outlet cable version, remove the screws on the main harness to the base.	For rear outlet cable version:
4	<p>Remove the main harness.</p> <p> Note</p> <p>For robots with protection class IP54 (option 3350-540)</p> <p>For robots with protection type Clean Room (option 3351-1)</p> <p>Check the gasket for the main harness.</p> <p> Tip</p> <p>Replace the gasket if needed.</p>	<p>For robots with protection class IP30 (option 3350-300)</p>  <p>xx2100000953</p> <p>For robots with protection class IP54 (option 3350-540)</p> <p>For robots with protection type Clean Room (option 3351-1)</p>  <p>xx2100002436</p>

Continues on next page

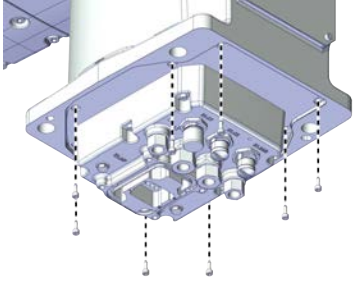
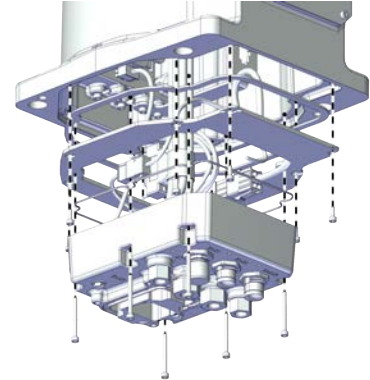
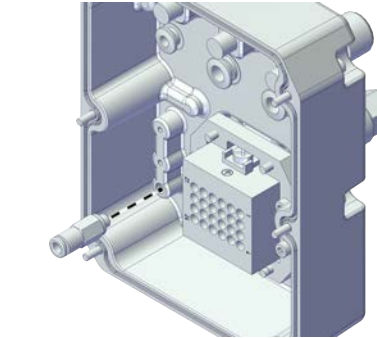
	Action	Note
5	For robot with underneath outlet cable version, remove the screws on the main harness assembly.	For underneath outlet cable version:
6	<p>Remove the main harness assembly.</p> <p> Note</p> <p>For robots with protection class IP54 (option 3350-540)</p> <p>For robots with protection type Clean Room (option 3351-1)</p> <p>Check the gasket for the main harness assembly.</p> <p> Tip</p> <p>Replace the gasket if needed.</p> <p> Note</p> <p>Remove the bottom plate from the main harness if needed.</p>	<p>For robots with protection class IP30 (option 3350-300)</p>  <p>xx2100001204</p> <p>For robots with protection class IP54 (option 3350-540)</p> <p>For robots with protection type Clean Room (option 3351-1)</p>  <p>xx2100002437</p>
7	<p>For robots with protection type Clean Room (option 3351-1)</p> <p>Remove the one way valve by unscrewing it.</p>	 <p>xx2200000281</p>

Removing the pulley protection cover

	Action	Note
1	<p> DANGER</p> <p>Make sure that all supplies for electrical power, hydraulic pressure, and air pressure are turned off.</p>	

Continues on next page



5 Repair

5.4.1 Replacing the base

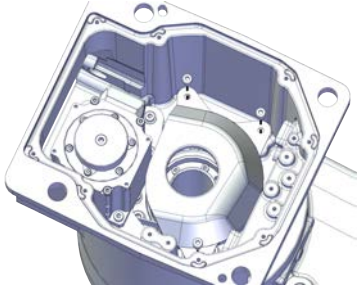
Continued

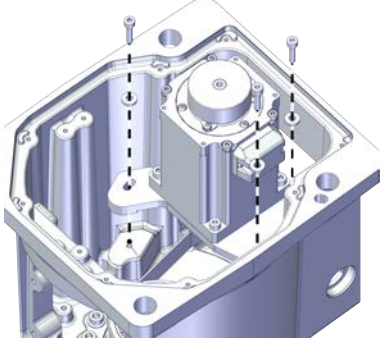

	Action	Note
2	 CAUTION For robots with protection type Clean Room Always cut the paint with a knife and grind the paint edge when disassembling parts of the robot! See Cut the paint or surface on the robot before replacing parts on page 118 .	
3	Remove the screws on the pulley protection cover to the base.	 xx2100001037
4	Remove the pulley protection cover.	

Removing the axis-1 motor sub-assembly



	Action	Note
1	 DANGER Make sure that all supplies for electrical power, hydraulic pressure, and air pressure are turned off.	
2	 CAUTION For robots with protection type Clean Room Always cut the paint with a knife and grind the paint edge when disassembling parts of the robot! See Cut the paint or surface on the robot before replacing parts on page 118 .	
3	Remove the screws and washers.	 xx2100001038
4	Remove the motor.	

Continues on next page

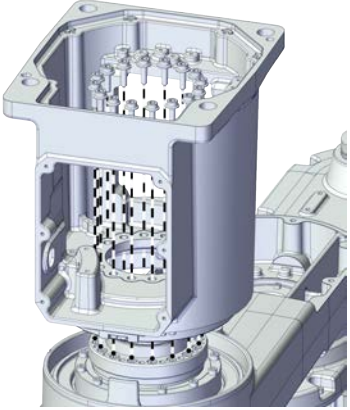
Removing the base from the axis-1 gear unit sub-assembly

	Action	Note
1	 DANGER Make sure that all supplies for electrical power, hydraulic pressure, and air pressure are turned off.	
2	 CAUTION For robots with protection type Clean Room Always cut the paint with a knife and grind the paint edge when disassembling parts of the robot! See Cut the paint or surface on the robot before replacing parts on page 118 .	
3	Remove the screws and washers on the base to the axis-1 gear unit.	 <p>xx2100001039</p>
4	Remove the base.	

Removing the block from the base

	Action	Note
1	 DANGER Make sure that all supplies for electrical power, hydraulic pressure, and air pressure are turned off.	
2	 CAUTION For robots with protection type Clean Room Always cut the paint with a knife and grind the paint edge when disassembling parts of the robot! See Cut the paint or surface on the robot before replacing parts on page 118 .	

Continues on next page



5 Repair

5.4.1 Replacing the base

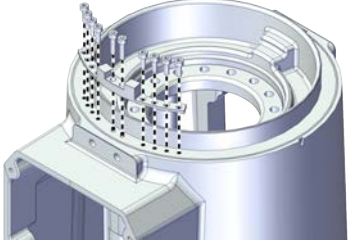
Continued

	Action	Note
3	Remove the screws.	 <p>xx2100001040</p>
4	Remove the block from the base	

Removing the air exhaust for Clean Room robots

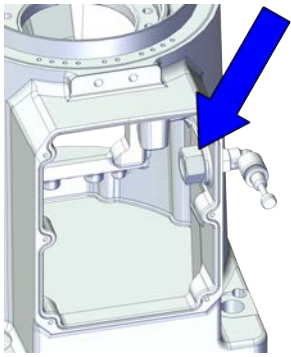
	Action	Note
1	 DANGER Make sure that all supplies for electrical power, hydraulic pressure, and air pressure are turned off.	
2	 CAUTION For robots with protection type Clean Room Always cut the paint with a knife and grind the paint edge when disassembling parts of the robot! See Cut the paint or surface on the robot before replacing parts on page 118 .	
3	For robots with protection type Clean Room (option 3351-1) Remove the air exhaust by unscrewing the locking nut	 <p>xx2200000280</p>

Continues on next page

Refitting the base

Use these procedures to refit the base.

Refitting the air exhaust for Clean Room robots

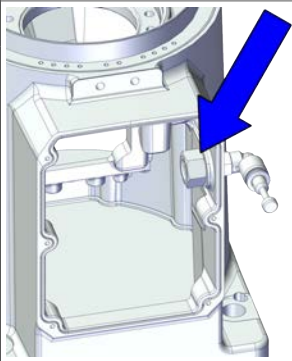
	Action	Note
1	<p>For robots with protection type Clean Room: Clean the joints that have been opened and wipe the parts free from particles with spirit on a lint free. See Cut the paint or surface on the robot before replacing parts on page 118</p> <p> Note</p> <p>After all repair work, wipe the Clean Room robot free from particles with spirit on a lint free cloth.</p>	
2	Refit the air exhaust back to the base.	
3	Secure with the nut.	

xx2200000280

Refitting the block to the base

	Action	Note
1	<p>For robots with protection type Clean Room: Clean the joints that have been opened and wipe the parts free from particles with spirit on a lint free. See Cut the paint or surface on the robot before replacing parts on page 118</p> <p> Note</p> <p>After all repair work, wipe the Clean Room robot free from particles with spirit on a lint free cloth.</p>	

Continues on next page

5 Repair

5.4.1 Replacing the base

Continued

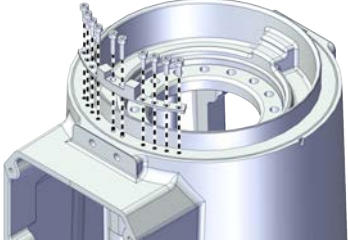
	Action	Note
2	Refit the block back to the base.	<p>Screws: Hex socket head cap screw M3x8 12.9 Lafre 2C2B/FC6.9 (8 pcs)</p> <p>Center: Hex socket head cap screw M3x12 12.9 Lafre 2C2B/FC6.9 (2 pcs)</p> <p>Tightening torque: 1.8 Nm</p>  <p>xx2100001040</p>
3	Secure with the screws.	

Refitting the base

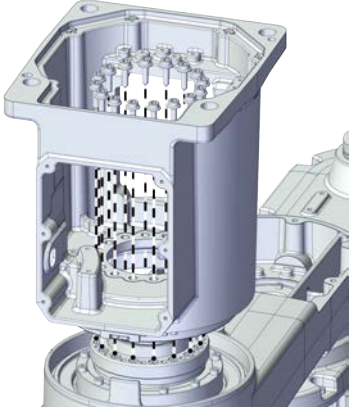
	Action	Note
1	<p>For robots with protection type Clean Room: Clean the joints that have been opened and wipe the parts free from particles with spirit on a lint free. See Cut the paint or surface on the robot before replacing parts on page 118</p> <p> Note</p> <p>After all repair work, wipe the Clean Room robot free from particles with spirit on a lint free cloth.</p>	
2	Refit the base to the axis-1 gearbox as the illustration.	<p>Screws: Hex socket head cap screw M5x16 12.9 Lafre 2C2B/FC6.9 (16 pcs)</p> <p>Washers: Plain washer 11x5.3x1.2 Steel (16 pcs)</p> <p>Tightening torque: 8.5 Nm±10%</p>  <p>xx2100001039</p>
3	Refit the screws.	

Continues on next page

Refitting the axis-1 motor sub-assembly

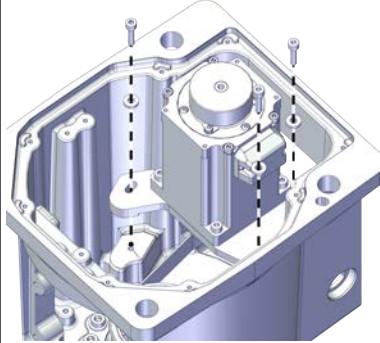
	Action	Note
1	<p>For robots with protection type Clean Room: Clean the joints that have been opened and wipe the parts free from particles with spirit on a lint free. See Cut the paint or surface on the robot before replacing parts on page 118</p> <p> Note</p> <p>After all repair work, wipe the Clean Room robot free from particles with spirit on a lint free cloth.</p>	
2	Put the timing belt into the pulley on the gear.	
3	<p>Refit the motor and refit the timing belt to the motor. Ensure that the belt runs correctly in the grooves.</p>	<p>Screws: Hex socket head cap screw M4x16 12.9 Lafre 2C2B/FC6.9 (3 pcs)</p>
4	Refit the screws and washers without fully tightened.	<p>Washers: Plain washer machining 4.2x9x2 steel (3 pcs)</p> <p>Tightening torque: 2.8 Nm \pm10%</p>  <p>xx2100001038</p> <p>Timing belt A1: 3HAC070449-001</p>
5	Hang a strap to the hook on the motor.	

Continues on next page

5 Repair

5.4.1 Replacing the base

Continued

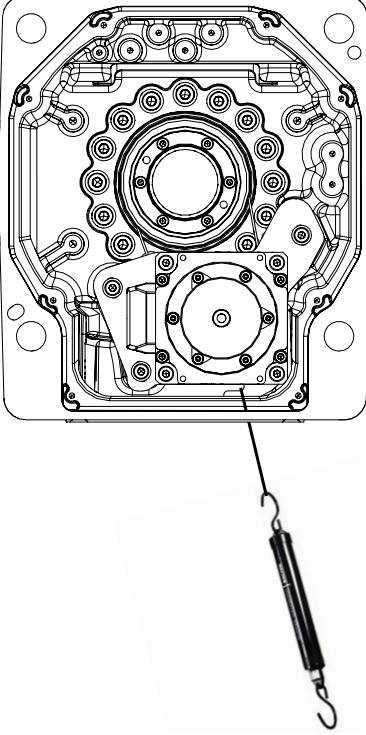
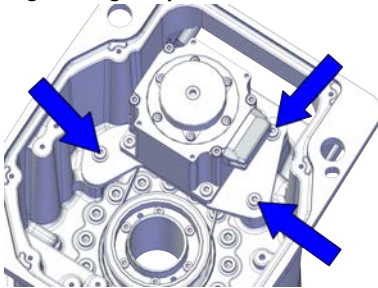
	Action	Note
6	<p>Use a handheld dynamometer hooking to the strap and pull the dynamometer to make the tension falling in the allowed force range.</p> <p> Note</p> <p>During the measurement, make sure that all interferences that may affect the force are removed. Pay attention to the force application direction.</p>	<p>Used belt: 51.1 New belt:90</p>  <p>xx2100001043</p>
7	<p>Fasten the screws to the recommended tightening torque.</p>	<p>Tightening torque: 2.8 Nm \pm10%</p>  <p>xx2100001044</p>
8	<p>Use a sonic tension meter to measure the timing belt tension.</p>	<p>Used belt: 308 New belt:250</p>
9	<p>If the timing belt tension does not meet the requirement, loosen the motor screws and readjust.</p>	

Refitting the pulley protection cover

	Action	Note
1	<p> DANGER</p> <p>Make sure that all supplies for electrical power, hydraulic pressure, and air pressure are turned off.</p>	

Continues on next page

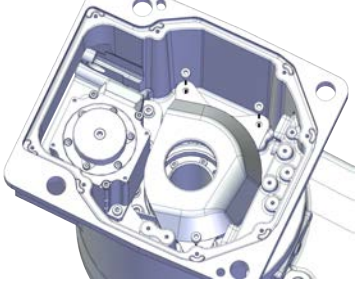
	Action	Note
2	 CAUTION For robots with protection type Clean Room Always cut the paint with a knife and grind the paint edge when disassembling parts of the robot! See Cut the paint or surface on the robot before replacing parts on page 118 .	
3	Refit the pulley protection cover.	Screws: Hex socket head cap screw M4x10 12.9 Lafre 2C2B/FC6.9 (8 pcs) Tightening torque: 0.8 Nm  <small>xx2100001037</small>
4	Secure the screws on the pulley protection cover to the base.	

Inserting the main harness through the axis -1 gearbox position





	Action	Note
1	For robots with protection type Clean Room: Clean the joints that have been opened and wipe the parts free from particles with spirit on a lint free. See Cut the paint or surface on the robot before replacing parts on page 118  Note After all repair work, wipe the Clean Room robot free from particles with spirit on a lint free cloth.	

Continues on next page

5 Repair

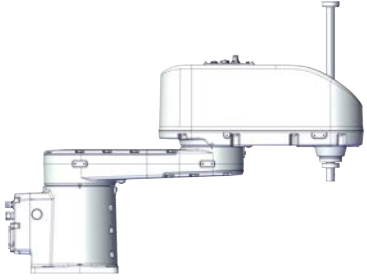
5.4.1 Replacing the base

Continued

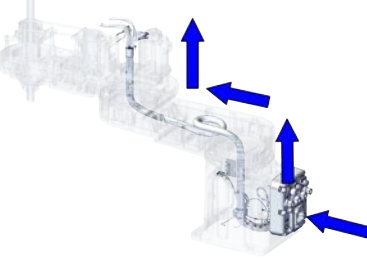
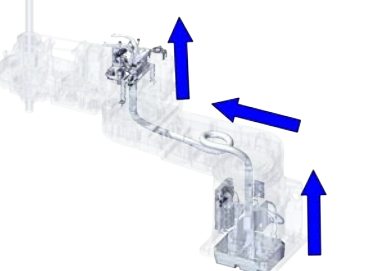
	Action	Note
2	<p>Make sure that the robot is at zero position.</p>	 <p>xx2100000930</p>
3	<p>Insert the internal harness into the inner arm through the sleeve of the axis-1 gearbox from the base.</p> <p> Tip Wrap the connectors with the masking tape.</p> <p> Tip The air hoses should face the axis-1 motor.</p> <p> CAUTION Make sure that no cables or hoses are twisted or strained. Reroute if necessary.</p>	<p>For rear outlet cable version:</p>  <p>xx2100000955</p> <p>For underneath outlet cable version:</p>  <p>xx2100001206</p>



Inserting the main harness through the axis -2 gearbox position

	Action	Note
1	<p>For robots with protection type Clean Room: Clean the joints that have been opened and wipe the parts free from particles with spirit on a lint free. See Cut the paint or surface on the robot before replacing parts on page 118</p> <p> Note After all repair work, wipe the Clean Room robot free from particles with spirit on a lint free cloth.</p>	

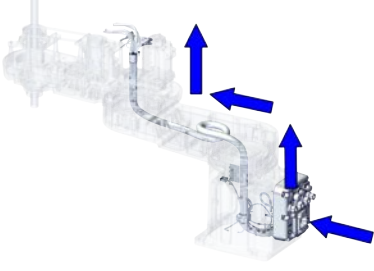
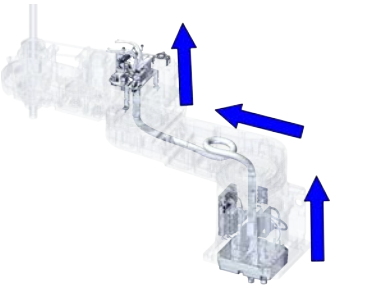
Continues on next page

	Action	Note
2	<p>Insert the internal harness into the outer arm through the plastic protection tube and the centre of the axis-2 gearbox.</p> <p> Tip Wrap the connectors with the masking tape.</p>	<p>For rear outlet cable version:</p>  <p>xx2100000955</p> <p>For underneath outlet cable version:</p>  <p>xx2100001206</p>
3	Secure the R2.MP3 and R2.MP4 with cable straps.	

Reconnecting the connectors for axis-1 motor

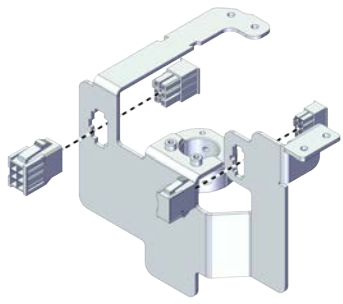

	Action	Note
1	<p>For robots with protection type Clean Room: Clean the joints that have been opened and wipe the parts free from particles with spirit on a lint free. See Cut the paint or surface on the robot before replacing parts on page 118</p> <p> Note After all repair work, wipe the Clean Room robot free from particles with spirit on a lint free cloth.</p>	
2	<p>Insert the female head of the connectors to the bracket accordingly.</p> <p> Tip The mistake proofing measure has been applied to the connectors, the connectors may be damaged if excessive force is used.</p> <p> Note The harness are not visible due to the cleanliness requirements of the illustration. They are still existing inside the cable ferrule in the actual situation.</p>	 <p>xx2100000950</p>

Continues on next page

5 Repair

5.4.1 Replacing the base

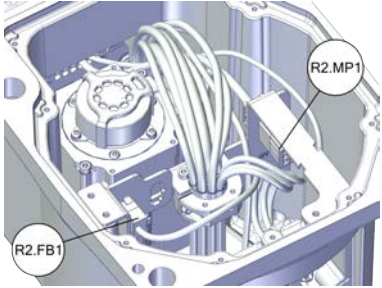
Continued

	Action	Note
3	<p>Reconnect the connectors.</p> <ul style="list-style-type: none"> • R2.MP1 • R2.FB1 <p> Tip</p> <p>See the number markings on the connectors for help to find the corresponding connector.</p>	 <p>xx2100000949</p>
4	<p>Route the cabling behind the axis-1 motor.</p> <p> CAUTION</p> <p>Correct cable routing is highly important. If the cables are routed and secured incorrectly the cables can be damaged.</p>	



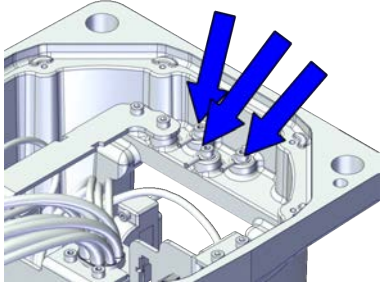

Reconnecting the grounding cable connectors

	Action	Note
1	<p>For robots with protection type Clean Room: Clean the joints that have been opened and wipe the parts free from particles with spirit on a lint free. See Cut the paint or surface on the robot before replacing parts on page 118</p> <p> Note</p> <p>After all repair work, wipe the Clean Room robot free from particles with spirit on a lint free cloth.</p>	
2	<p>Secure the three grounding cables to the bracket with the screw.</p>	<p>Screws: Hex socket head cap screw M3x5 12.9 Lafre 2C2B/FC6.9 (3 pcs) Tightening torque: 1.5 Nm \pm10%</p>  <p>xx2100000947</p>

Continues on next page

	Action	Note
3	<p>Route and secure the cabling with cable straps if needed.</p> <p> CAUTION</p> <p>Correct cable routing is highly important. If the cables are routed and secured incorrectly the cables can be damaged.</p>	

Refitting the base bracket

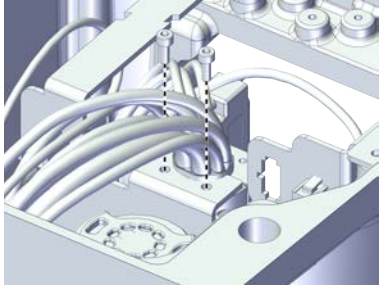
	Action	Note
1	<p> DANGER</p> <p>Make sure that all supplies for electrical power, hydraulic pressure, and air pressure are turned off.</p>	
2	<p> CAUTION</p> <p>For robots with protection type Clean Room Always cut the paint with a knife and grind the paint edge when disassembling parts of the robot! See Cut the paint or surface on the robot before replacing parts on page 118.</p>	
3	<p>Lay the main harness in a natural state without distortion.</p> <p>Secure the cable ferrule to the bracket.</p> <p> Tip</p> <p>Align all the cable ferrules so that the cable is in a natural bending position to avoid twisting.</p> <p> Note</p> <p>The harness are not visible due to the cleanness requirements of the illustration. They are still existing inside the cable ferrule in the actual situation.</p>	<p>Screws: Hex socket head cap screw M3x8 12.9 Lafre 2C2B/FC6.9 (2 pcs) Tightening torque: 1.2 Nm ±10%</p>  <p>xx2100000951</p>

Continues on next page



5 Repair

5.4.1 Replacing the base

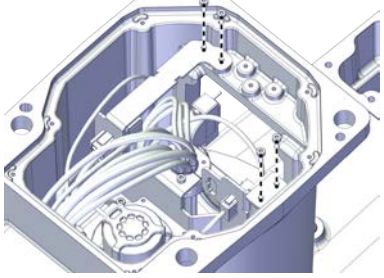

Continued

	Action	Note
4	Refit the base bracket to the base and secure with the screws.	<p>Screws: Hex socket head cap screw M3x8 12.9 Lafre 2C2B/FC6.9 (4 pcs) Tightening torque: 1.2 Nm \pm10%</p>  <p>xx2100000948</p>

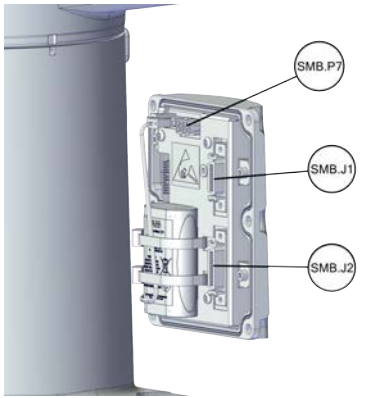
Refitting the SMB cover

	Action	Note
1	<p>For robots with protection type Clean Room: Clean the joints that have been opened and wipe the parts free from particles with spirit on a lint free. See Cut the paint or surface on the robot before replacing parts on page 118</p> <p> Note</p> <p>After all repair work, wipe the Clean Room robot free from particles with spirit on a lint free cloth.</p>	
2	<p>Reconnect the connectors.</p> <ul style="list-style-type: none"> • SMB.P7 • SMB.J1 • SMB.J2 <p> Tip</p> <p>Take photos of the connector and cable position before disconnecting them, to have as a reference when reconnecting.</p>	 <p>xx2100000945</p>

Continues on next page

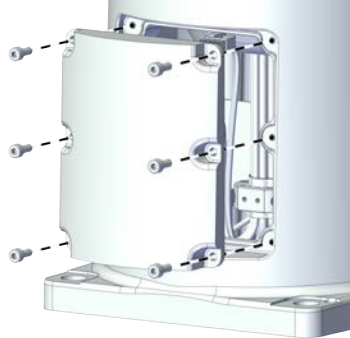
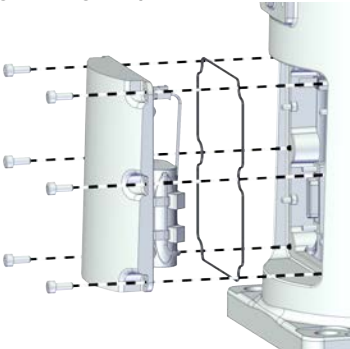
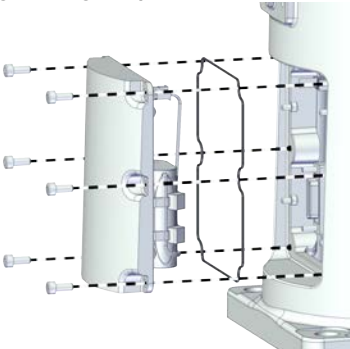
	Action	Note
3	<p>Refit the SMB cover assembly.</p> <p> Note</p> <p>For robots with protection class IP54 (option 3350-540)</p> <p>For robots with protection type Clean Room (option 3351-1)</p> <p>Check the gasket for the SMB cover.</p> <p> Tip</p> <p>Replace the gasket if needed.</p>	<p>For robots with protection class IP30 (option 3350-300)</p> <p>Screws: Hex socket head cap screw M4x10 12.9 Lafre 2C2B/FC6.9 (6 pcs)</p> <p>Tightening torque: 2.6 Nm</p> 
4	<p>Secure the SMB cover to the base with the screws.</p>	<p>xx210000944</p> <p>For robots with protection type Clean Room (option 3351-1)</p> <p>Screws: Stainless Screw Hexagon Socket Head Cap, Clean Room 3HAC075438-001 (6 pcs)</p> <p>Tightening torque: 2.6 Nm</p>  <p>xx2100002433</p> <p>For robots with protection class IP54 (option 3350-540)</p> <p>Screws: Hex socket head cap screw M4x10 12.9 Lafre 2C2B/FC6.9 (6 pcs)</p> <p>Tightening torque: 2.6 Nm</p>  <p>xx2100002433</p>

Continues on next page

5 Repair

5.4.1 Replacing the base

Continued

Refitting the main harness

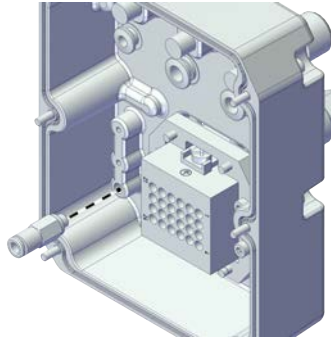
	Action	Note
1	<p>For robots with protection type Clean Room: Clean the joints that have been opened and wipe the parts free from particles with spirit on a lint free. See Cut the paint or surface on the robot before replacing parts on page 118</p> <p> Note</p> <p>After all repair work, wipe the Clean Room robot free from particles with spirit on a lint free cloth.</p>	
2	<p>For robots with protection type Clean Room (option 3351-1) Refit the one way valve by screwing it into the main harness assembly.</p>	 xx2200000281

Continues on next page

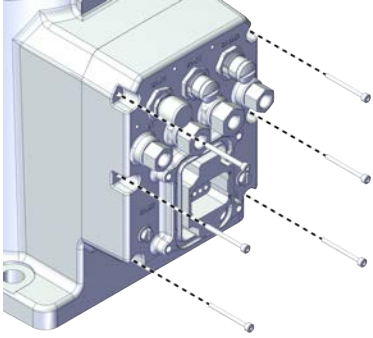
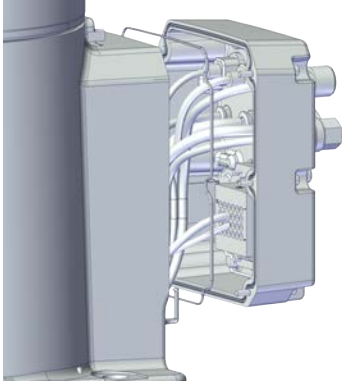
	Action	Note
3	For rear outlet cable version, refit the main harness to the base.	For rear outlet cable version:
4	Secure with the screws.	<p>For robots with protection class IP30 (option 3350-300)</p> <p>Screws: Hex socket head cap screw M3x30 12.9 Lafre 2C2B/FC6.9 (6 pcs)</p> <p>Tightening torque: 1.2 Nm ±10%</p>  <p>xx2100000953</p> <p>For robots with protection class IP54 (option 3350-540)</p> <p>For robots with protection type Clean Room (option 3351-1)</p> <p>Screws: Hex socket head cap screw M3x30 12.9 Lafre 2C2B/FC6.9 (6 pcs)</p> <p>Tightening torque: 1.2 Nm ±10%</p>  <p>xx2100002436</p>

Continues on next page

5 Repair

5.4.1 Replacing the base

Continued

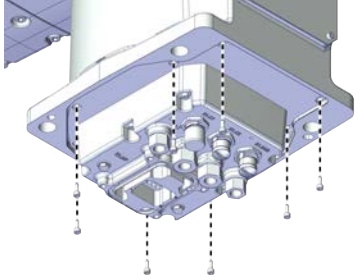
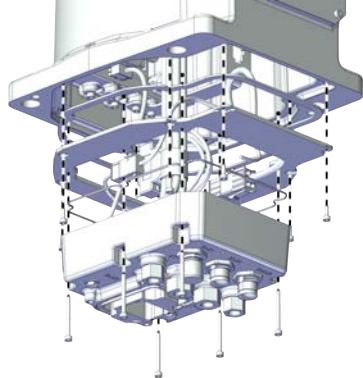
	Action	Note
5	<p>For underneath outlet cable version, refit the main harness assembly to the base.</p> <p> Note</p> <p>Refit the bottom plate to the main harness if needed.</p>	<p>For underneath outlet cable version:</p> <p>For robots with protection class IP30 (option 3350-300)</p> <p>Screws: Hex socket head cap screw M3x30 12.9 Lafre 2C2B/FC6.9 (8 pcs)</p> <p>Tightening torque: 1.2 Nm \pm10%</p>
6	Secure with the screws.	<p></p> <p>xx2100001204</p> <p>For robots with protection class IP54 (option 3350-540)</p> <p>For robots with protection type Clean Room (option 3351-1)</p> <p>Screws: Hex socket head cap screw M3x30 12.9 Lafre 2C2B/FC6.9 (8 pcs)</p> <p>Tightening torque: 1.2 Nm \pm10%</p> <p></p> <p>xx2100002437</p>

Refitting the base plate/ rear plate

	Action	Note
1	<p>For robots with protection type Clean Room:</p> <p>Clean the joints that have been opened and wipe the parts free from particles with spirit on a lint free. See Cut the paint or surface on the robot before replacing parts on page 118</p> <p> Note</p> <p>After all repair work, wipe the Clean Room robot free from particles with spirit on a lint free cloth.</p>	





Continues on next page

	Action	Note
2	Apply grease to the internal harness, cover all moving area of the harness.	

5 Repair

5.4.1 Replacing the base

Continued

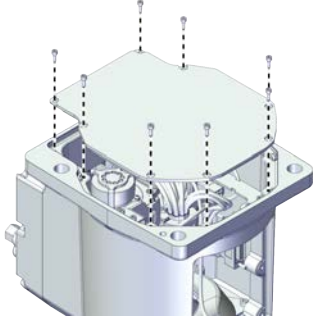
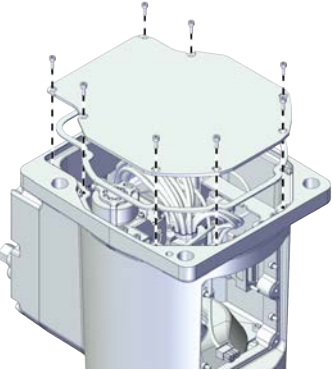
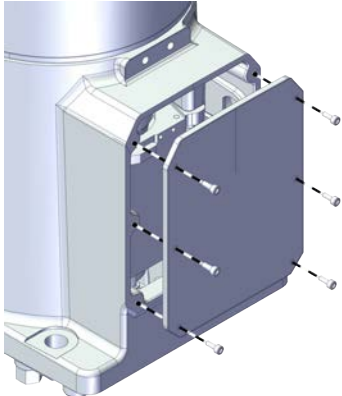
	Action	Note
3	<p>For rear outlet cable version, refit the base plate to the base.</p> <p> Note</p> <p>For robots with protection class IP54 (option 3350-540) For robots with protection type Clean Room (option 3351-1) Check the gasket for the base plate before refitting the base plate.</p> <p> Tip</p> <p>Replace the gasket if needed.</p> <p>For undeneath outlet cable version, refit the rear plate to the base.</p> <p> Note</p> <p>For robots with protection class IP54 (option 3350-540) For robots with protection type Clean Room (option 3351-1) Check the gasket for the rear plate before refitting the rear plate.</p> <p> Tip</p> <p>Replace the gasket if needed.</p>	<p>Screws: Hex socket head cap screw M3x30 12.9 Lafre 2C2B/FC6.9 (6 pcs) Tightening torque: 1.2 Nm ±10%</p> <p>For rear outlet cable version: For robots with protection class IP30 (option 3350-300)</p>  <p>xx2100000946</p> <p>For robots with protection class IP54 (option 3350-540) For robots with protection type Clean Room (option 3351-1)</p>  <p>xx2100002434</p> <p>For undeneath outlet cable version: For robots with protection class IP30 (option 3350-300)</p>  <p>xx2100001202</p>
4	<p>Secure the base plate/ rear plate to the base with the screws.</p>	

Continues on next page

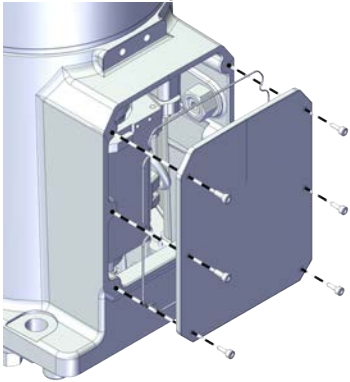
	Action	Note
		<p>For robots with protection class IP54 (option 3350-540)</p> <p>For robots with protection type Clean Room (option 3351-1)</p>  <p>xx2100002435</p>
5	Refit the robot back to the ground.	
6	Secure with the screws.	<p>Screws: Hex socket head cap screw M12x35 12.9 Gleitmo 603+Geomet 500 (4 pcs)</p> <p>Steel</p> <p>Washers: 24 mm x 13 mm x 2.5 mm (4 pcs)</p> <p>Tightening torque: 56 Nm ±10%</p>







Refitting the cable ferrule and bracket in the outer arm

	Action	Note
1	<p>For robots with protection type Clean Room: Clean the joints that have been opened and wipe the parts free from particles with spirit on a lint free. See Cut the paint or surface on the robot before replacing parts on page 118</p> <p> Note</p> <p>After all repair work, wipe the Clean Room robot free from particles with spirit on a lint free cloth.</p>	
2	Lay the internal harness in a natural state without distortion.	

5 Repair

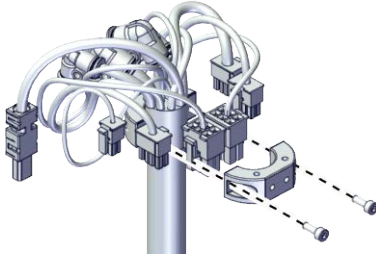

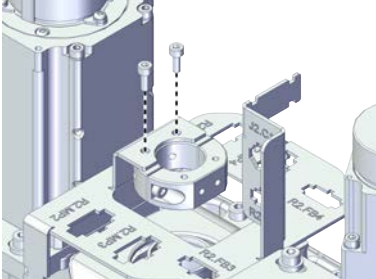



5.4.1 Replacing the base

Continued

	Action	Note
3	<p>Refit the cable ferrule and secure it with the screws.</p> <p> Tip</p> <p>The air hoses should face the process hub side.</p> <p> Tip</p> <p>The position with wrapped tape is the marked position for the cable ferrule.</p> <p> Tip</p> <p>Align all the cable ferrules so that the cable is in a natural bending position to avoid twisting.</p>	<p>Screws: Hex socket head cap screw M3x8 12.9 Lafre 2C2B/FC6.9 (2 pcs)</p> <p>Tightening torque: 1.2 Nm ±10%</p>  <p>xx1800002849</p>
4	<p>Secure the cable ferrule to the bracket.</p> <p> Tip</p> <p>Align all the cable ferrules so that the cable is in a natural bending position to avoid twisting.</p> <p> Note</p> <p>The harness are not visible due to the cleanness requirements of the illustration. They are still existing inside the cable ferrule in the actual situation.</p>	<p>Screws: Hex socket head cap screw M3x8 12.9 Lafre 2C2B/FC6.9 (2 pcs)</p> <p>Tightening torque: 1.2 Nm ±10%</p>  <p>xx2100000940</p>
5	<p>Refit the bracket without securing.</p> <p> Tip</p> <p>Do not secure it with the screws before the cable ferrule installed well.</p> <p> Note</p> <p>The harness are not visible due to the cleanness requirements of the illustration. They are still existing inside the cable ferrule in the actual situation.</p>	

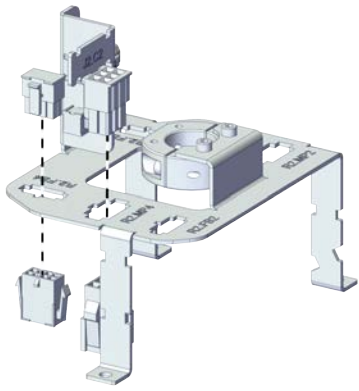
Continues on next page

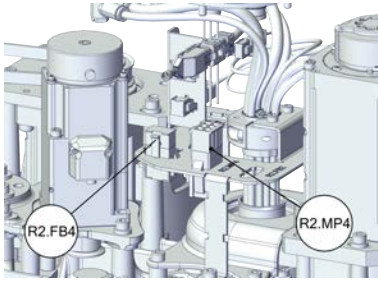
Reconnecting the connectors for axis-4 motor

	Action	Note
1	<p>For robots with protection type Clean Room: Clean the joints that have been opened and wipe the parts free from particles with spirit on a lint free. See Cut the paint or surface on the robot before replacing parts on page 118</p> <p> Note</p> <p>After all repair work, wipe the Clean Room robot free from particles with spirit on a lint free cloth.</p>	
	<p>Insert the female head of the connectors to the bracket accordingly.</p> <p> Tip</p> <p>The mistake proofing measure has been applied to the connectors, the connectors may be damaged if excessive force is used.</p> <p> Note</p> <p>The harness are not visible due to the cleanness requirements of the illustration. They are still existing inside the cable ferrule in the actual situation.</p>	 <p>xx210000939</p>
2	<p>Reconnect the connectors.</p> <ul style="list-style-type: none"> • R2.MP4 • R2.FB4 <p> Tip</p> <p>See the number markings on the connectors for help to find the corresponding connector.</p>	 <p>xx210000938</p>
3	<p>Route the cabling on the axis-4 motor.</p> <p> CAUTION</p> <p>Correct cable routing is highly important. If the cables are routed and secured incorrectly the cables can be damaged.</p>	







Continues on next page

5 Repair

5.4.1 Replacing the base

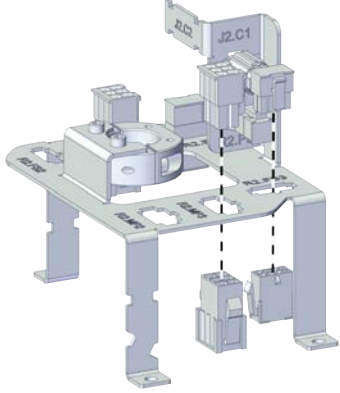

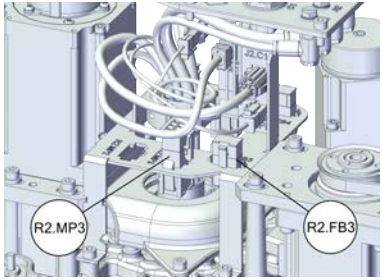



Continued

Reconnecting the connectors for axis-3 motor

	Action	Note
1	<p>For robots with protection type Clean Room: Clean the joints that have been opened and wipe the parts free from particles with spirit on a lint free. See Cut the paint or surface on the robot before replacing parts on page 118</p> <p> Note</p> <p>After all repair work, wipe the Clean Room robot free from particles with spirit on a lint free cloth.</p>	
2	<p>Insert the female head of the connectors to the bracket accordingly.</p> <p> Tip</p> <p>The mistake proofing measure has been applied to the connectors, the connectors may be damaged if excessive force is used.</p> <p> Note</p> <p>The harness are not visible due to the cleanness requirements of the illustration. They are still existing inside the cable ferrule in the actual situation.</p>	 <p>xx2100000937</p>
3	<p>Reconnect the connectors.</p> <ul style="list-style-type: none"> • R2.MP3 • R2.FB3 <p> Tip</p> <p>See the number markings on the connectors for help to find the corresponding connector.</p>	 <p>xx2100000936</p>
4	<p>Route the cabling on the axis-3 motor.</p> <p> CAUTION</p> <p>Correct cable routing is highly important. If the cables are routed and secured incorrectly the cables can be damaged.</p>	

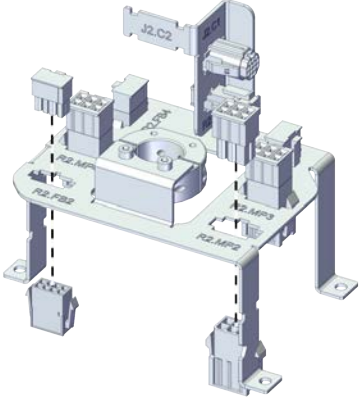
Continues on next page

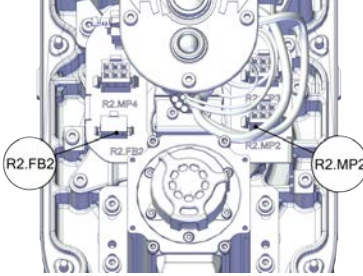
Reconnecting the connectors for axis-2 motor

	Action	Note
1	<p>For robots with protection type Clean Room: Clean the joints that have been opened and wipe the parts free from particles with spirit on a lint free. See Cut the paint or surface on the robot before replacing parts on page 118</p> <p> Note</p> <p>After all repair work, wipe the Clean Room robot free from particles with spirit on a lint free cloth.</p>	
2	<p>Insert the female head of the connectors to the bracket accordingly.</p> <p> Tip</p> <p>The mistake proofing measure has been applied to the connectors, the connectors may be damaged if excessive force is used.</p> <p> Note</p> <p>The harness are not visible due to the cleanness requirements of the illustration. They are still existing inside the cable ferrule in the actual situation.</p>	 <p>xx2100000935</p>
3	<p>Reconnect the connectors.</p> <ul style="list-style-type: none"> • R2.MP2 • R2.FB2 <p> Tip</p> <p>See the number markings on the connectors for help to find the corresponding connector.</p>	 <p>xx2100000934</p>
4	<p>Route the cabling behind the axis-2 motor.</p> <p> CAUTION</p> <p>Correct cable routing is highly important. If the cables are routed and secured incorrectly the cables can be damaged.</p>	







Continues on next page

5 Repair

5.4.1 Replacing the base

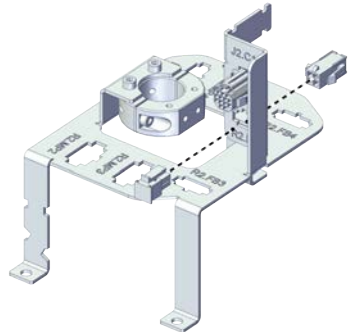

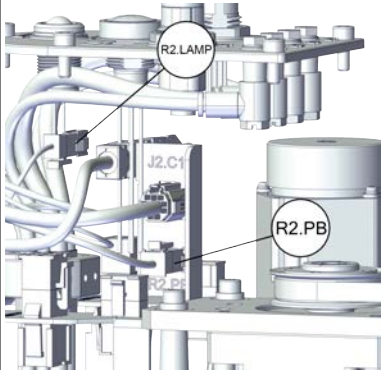
Continued

Reconnecting the connector for PB

	Action	Note
1	<p>For robots with protection type Clean Room: Clean the joints that have been opened and wipe the parts free from particles with spirit on a lint free. See Cut the paint or surface on the robot before replacing parts on page 118</p> <p> Note</p> <p>After all repair work, wipe the Clean Room robot free from particles with spirit on a lint free cloth.</p>	
2	<p>Insert the female head of the PB connector to the bracket accordingly.</p> <p> Tip</p> <p>The mistake proofing measure has been applied to the connectors, the connectors may be damaged if excessive force is used.</p> <p> Note</p> <p>The harness are not visible due to the cleanness requirements of the illustration. They are still existing inside the cable ferrule in the actual situation.</p>	 <p>xx2100001031</p>
3	<p>Reconnect the connector.</p> <ul style="list-style-type: none"> • R2.PB • R2.LAMP <p> Tip</p> <p>See the number markings on the connectors for help to find the corresponding connector.</p>	 <p>xx2100001030</p>
4	<p>Route and secure the cabling with cable straps if needed.</p> <p> CAUTION</p> <p>Correct cable routing is highly important. If the cables are routed incorrectly the cables can be damaged.</p>	

Continues on next page

Reconnecting the air hoses, CP/CS cabling and Ethernet cabling (if equipped)







	Action	Note
1	<p>For robots with protection type Clean Room: Clean the joints that have been opened and wipe the parts free from particles with spirit on a lint free. See Cut the paint or surface on the robot before replacing parts on page 118</p> <p> Note</p> <p>After all repair work, wipe the Clean Room robot free from particles with spirit on a lint free cloth.</p>	
2	<p>Route the air hoses on the process hub behind the bracket.</p> <p> CAUTION</p> <p>Correct cable routing is highly important. If the cables are routed and secured incorrectly the cables can be damaged.</p>	

Continues on next page

5 Repair

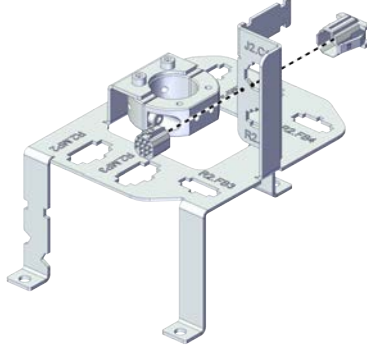
5.4.1 Replacing the base

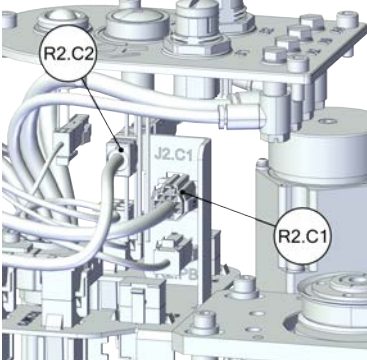

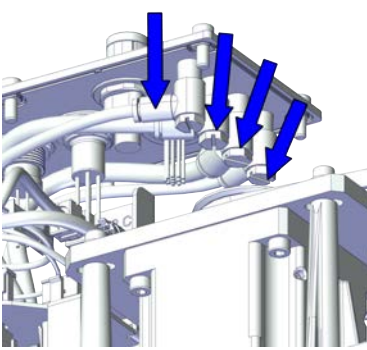
Continued

	Action	Note
3	<p>Insert the female head of the C1 cabling connector to the bracket accordingly.</p> <p> Tip</p> <p>The mistake proofing measure has been applied to the connectors, the connectors may be damaged if excessive force is used.</p> <p> Note</p> <p>The harness are not visible due to the cleanness requirements of the illustration. They are still existing inside the cable ferrule in the actual situation.</p>	 <p>xx2100001034</p>
4	<p>For robots with C1 cabling</p> <p>Reconnect the connector.</p> <ul style="list-style-type: none"> • R2.C1 <p> Tip</p> <p>See the number markings on the air hoses for help to find the corresponding air hoses.</p> <p>The air hoses with the same number connect to the same L-shaped connector.</p>	 <p>xx2100001033</p>
5	<p>For robots with C2 cabling</p> <p>Reconnect the connector.</p> <ul style="list-style-type: none"> • R1.C2 <p> Tip</p> <p>See the number markings on the air hoses for help to find the corresponding air hoses.</p> <p>The air hoses with the same number connect to the same L-shaped connector.</p>	
6	<p>Secure the C2 cabling to the C2 bracket with the cable straps.</p>	
7	<p>Reconnect the air hoses in a cross pattern with the L-shaped connectors.</p> <p> Tip</p> <p>See the number markings on the air hoses for help to find the corresponding air hoses.</p> <p>The air hoses with the same number connect to the same Y-shaped connector.</p>	 <p>xx2100001032</p>

Continues on next page

	Action	Note
8	<p>Route and secure the cabling with cable straps if needed.</p> <p> CAUTION</p> <p>Correct cable routing is highly important. If the cables are routed and secured incorrectly the cables can be damaged.</p>	

Securing the bracket in the outer arm

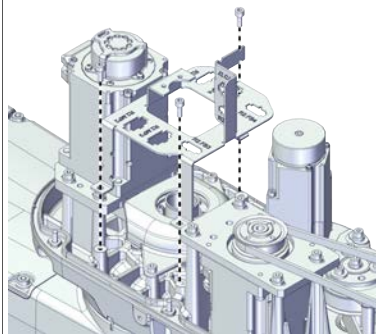
	Action	Note
1	<p>For robots with protection type Clean Room: Clean the joints that have been opened and wipe the parts free from particles with spirit on a lint free. See Cut the paint or surface on the robot before replacing parts on page 118</p> <p> Note</p> <p>After all repair work, wipe the Clean Room robot free from particles with spirit on a lint free cloth.</p>	
2	<p>Refit the bracket.</p> <p> Tip</p> <p>Do not secure it with the screws before the cable ferrule installed well.</p> <p> Note</p> <p>The harness are not visible due to the cleanness requirements of the illustration. They are still existing inside the cable ferrule in the actual situation.</p>	<p>Screws: Hex socket head cap screw M4x10 12.9 Lafre 2C2B/FC6.9 (3 pcs) Tightening torque: 1.2 Nm \pm10%</p>  <p>xx2100000941</p>

Refitting the cover of the outer arm



	Action	Note
1	<p>For robots with protection type Clean Room: Clean the joints that have been opened and wipe the parts free from particles with spirit on a lint free. See Cut the paint or surface on the robot before replacing parts on page 118</p> <p> Note</p> <p>After all repair work, wipe the Clean Room robot free from particles with spirit on a lint free cloth.</p>	

Continues on next page

5 Repair

5.4.1 Replacing the base

Continued

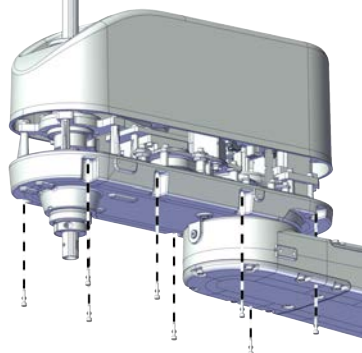
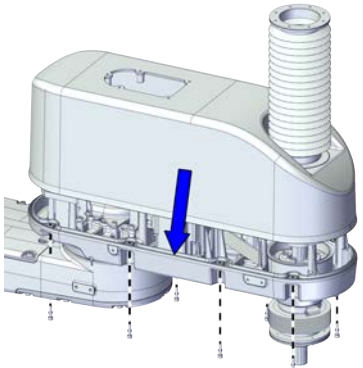

	Action	Note
2	<p>Refit the cover.</p> <p> Note</p> <p>For robots with protection class IP54 (option 3350-540)</p> <p>For robots with protection type Clean Room (option 3351-1)</p> <p>Refit the cover with bellow.</p> <p>Check the gasket for the outer arm cover.</p> <p> Tip</p> <p>Replace the gasket if needed.</p> <p> CAUTION</p> <p>The gasket is in the outer arm.</p>	<p>Screw: Hex socket head cap screw M4x16 12.9 Lafre 2C2B/FC6.9 (8 pcs)</p> <p>Tightening torque: 2 Nm ±10%</p> <p>For robots with protection class IP30 (option 3350-300)</p>  <p>xx210000933</p>
3	<p>Refit the screws.</p>	<p>For robots with protection class IP54 (option 3350-540)</p> <p>For robots with protection type Clean Room (option 3351-1)</p>  <p>xx2100002427</p>

For Clean Room/ IP54 robots

Refitting the top cover and the flange with bearing

	Action	Note
1	<p>For robots with protection type Clean Room:</p> <p>Clean the joints that have been opened and wipe the parts free from particles with spirit on a lint free. See Cut the paint or surface on the robot before replacing parts on page 118</p> <p> Note</p> <p>After all repair work, wipe the Clean Room robot free from particles with spirit on a lint free cloth.</p>	

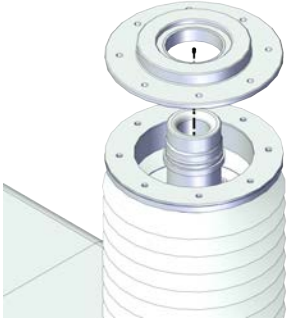
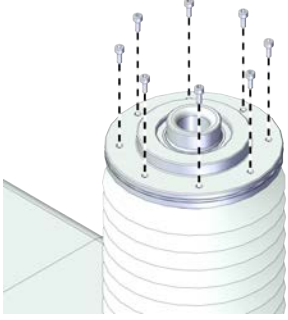
Continues on next page

	Action	Note
2	<p>For robots with protection class IP54 (option 3350-540) For robots with protection type Clean Room (option 3351-1) Install the flange with bearing to the extension shaft.</p>	 <p>xx2100002402</p>
3	<p>For robots with protection class IP54 (option 3350-540) For robots with protection type Clean Room (option 3351-1) Refit the screws to the flange with bearing.</p>	<p>Screws: Hex socket head cap screw M2.5x6 12.9 Lafre 2C2B/FC6.9 (8 pcs) Tightening torque: 0.8 Nm ±10%</p>  <p>xx2100002401</p>
4	<p>For robots with protection class IP54 (option 3350-540) For robots with protection type Clean Room (option 3351-1) Refit the top cover to the ball screw.</p> <p> Tip</p> <p>The top surface of the cover should be flush with the top end of the ball screw.</p>	 <p>xx2100002399</p>

Continues on next page

5 Repair

5.4.1 Replacing the base

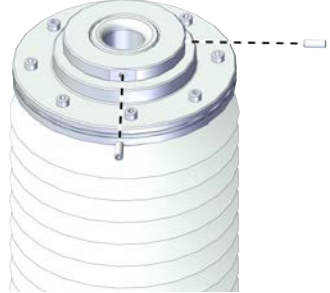

Continued

	Action	Note
5	<p>For robots with protection class IP54 (option 3350-540)</p> <p>For robots with protection type Clean Room (option 3351-1)</p> <p>Refit the locking screws.</p>	<p>Screws: Hexagon socket set screws with flat point, ISO 4026 stainless steel M3x8 (2 pcs)</p> <p>Tightening torque: 0.4 Nm \pm10%</p>  <p>xx2100002398</p>

Securing the process hub to outer arm cover

	Action	Note
1	<p>For robots with protection type Clean Room:</p> <p>Clean the joints that have been opened and wipe the parts free from particles with spirit on a lint free. See Cut the paint or surface on the robot before replacing parts on page 118</p> <p> Note</p> <p>After all repair work, wipe the Clean Room robot free from particles with spirit on a lint free cloth.</p>	
2	Insert the process hub from the outer arm cover.	

Continues on next page

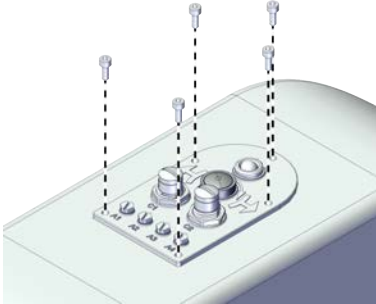
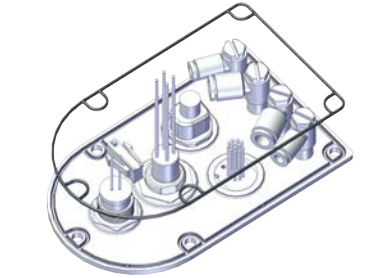
	Action	Note
3	<p>Secure the process hub to the outer arm cover with the screws.</p> <p> Note</p> <p>For robots with protection class IP54 (option 3350-540)</p> <p>For robots with protection type Clean Room (option 3351-1)</p> <p>Check the gasket for the process hub.</p> <p> Tip</p> <p>Replace the gasket if needed.</p> <p> CAUTION</p> <p>Be aware of the cabling that is attached to the cover! The cover can not be removed completely until the connectors are disconnected, as shown in following steps.</p>	<p>Screws: Hex socket head cap screw M4x10 12.9 Lafre 2C2B/FC6.9 (5 pcs)</p> <p>Tightening torque: 2.6 Nm±10%</p> <p>For robots with protection class IP30 (option 3350-300)</p>  <p>xx2100000932</p> <p>For robots with protection class IP54 (option 3350-540)</p> <p>For robots with protection type Clean Room (option 3351-1)</p>  <p>xx2100002438</p>

Refitting the axis-1 cover



	Action	Note
1	<p>For robots with protection type Clean Room:</p> <p>Clean the joints that have been opened and wipe the parts free from particles with spirit on a lint free. See Cut the paint or surface on the robot before replacing parts on page 118</p> <p> Note</p> <p>After all repair work, wipe the Clean Room robot free from particles with spirit on a lint free cloth.</p>	

Continues on next page

5 Repair

5.4.1 Replacing the base

Continued

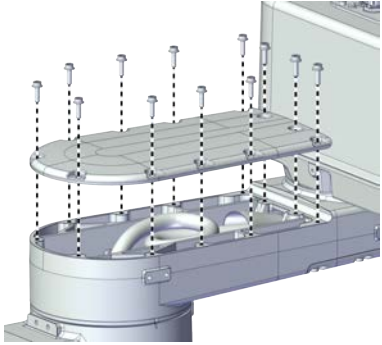
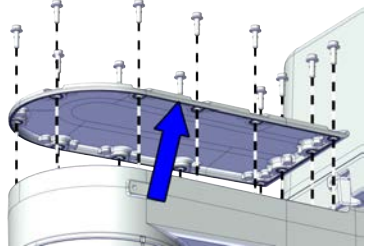
	Action	Note
2	<p>Refit the cover.</p> <p> Note</p> <p>For robots with protection class IP54 (option 3350-540)</p> <p>For robots with protection type Clean Room (option 3351-1)</p> <p>Check the gasket for the cover before refitting the cover.</p> <p> Tip</p> <p>Replace the gasket if needed.</p>	<p>For IRB 920T-6/0.45 : Screw: Hex socket head cap flange screw M5x16 12.9 Lafre 2C2B/FC6.9+PrO-COat111 (10 pcs)</p> <p>For IRB 920T-6/0.55 : Screw: Hex socket head cap flange screw M5x16 12.9 Lafre 2C2B/FC6.9+PrO-COat111 (12 pcs)</p> <p>For IRB 920T-6/0.65 : Screw: Hex socket head cap flange screw M5x16 12.9 Lafre 2C2B/FC6.9+PrO-COat111 (16 pcs)</p> <p>Tightening torque: 5.4 Nm \pm3%</p> <p>For robots with protection class IP30 (option 3350-300)</p>
3	<p>Refit the screws.</p>	<p></p> <p>xx2100000942</p> <p>For robots with protection class IP54 (option 3350-540)</p> <p>For robots with protection type Clean Room (option 3351-1)</p> <p></p> <p>xx2100002428</p>

Refitting the axis-2 cover

	Action	Note
1	<p> DANGER</p> <p>Make sure that all supplies for electrical power, hydraulic pressure, and air pressure are turned off.</p>	



Continues on next page

	Action	Note
2	<p> CAUTION</p> <p>For robots with protection type Clean Room Always cut the paint with a knife and grind the paint edge when disassembling parts of the robot! See <i>Cut the paint or surface on the robot before replacing parts on page 118.</i></p>	

5 Repair

5.4.1 Replacing the base

Continued

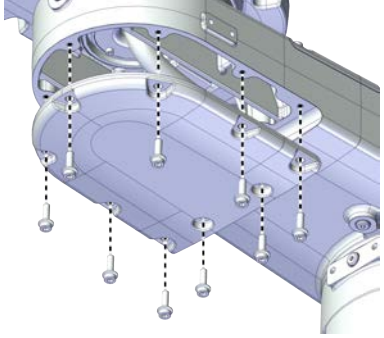
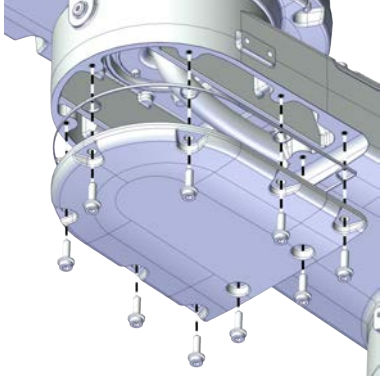
	Action	Note
3	<p>Refit the cover.</p> <p> Note</p> <p>For robots with protection class IP54 (option 3350-540)</p> <p>For robots with protection type Clean Room (option 3351-1)</p> <p>Check the gasket for the cover before refitting the cover.</p> <p> Tip</p> <p>Replace the gasket if needed.</p>	<p>Screws: Hex socket head cap flange screw M5x16 12.9 Lafre 2C2B/FC6.9+PrO-COat111 (9 pcs)</p> <p>Tightening torque: 1.2 Nm \pm10%</p> <p>For robots with protection class IP30 (option 3350-300)</p>  <p>xx210000943</p> <p>For robots with protection class IP54 (option 3350-540)</p> <p>For robots with protection type Clean Room (option 3351-1)</p>  <p>xx2100002451</p>
4	<p>Refit the screws.</p>	

Concluding procedure

	Action	Note
1	<p>For robots with protection type Clean Room:</p> <p>Seal and paint the joints that have been opened. See Cut the paint or surface on the robot before replacing parts on page 118</p> <p> Note</p> <p>After all repair work, wipe the Clean Room robot free from particles with spirit on a lint free cloth.</p>	
2	<p>Recalibrate the robot.</p>	<p>Calibration is detailed in section Calibration on page 945.</p>

Continues on next page

	Action	Note
3	 DANGER Make sure all safety requirements are met when performing the first test run.	

5 Repair

5.4.2 Replacing the axis-1 timing belt

5.4.2 Replacing the axis-1 timing belt

Location of the axis-1 timing belt

The axis-1 timing belt is located as shown in the figure.

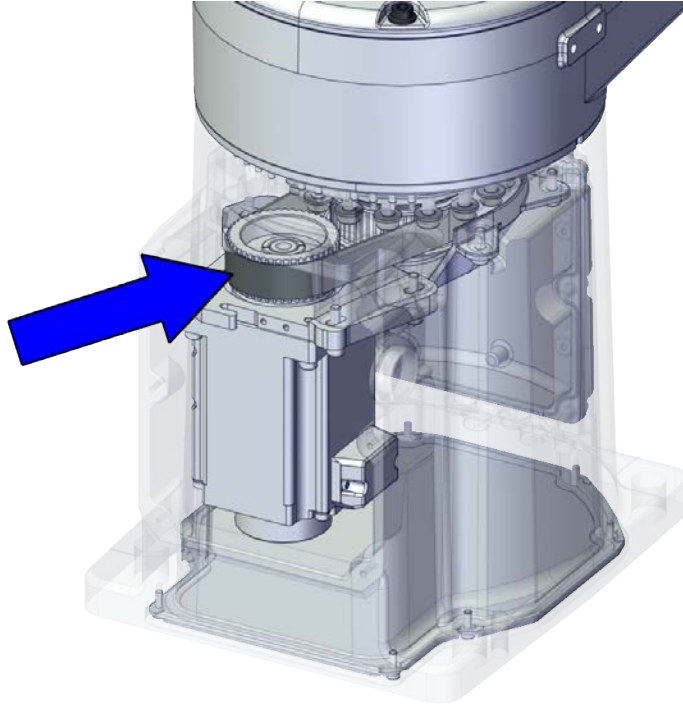

xx2100001015

Required spare parts



Note

The spare part numbers that are listed in the table can be out of date. See the latest spare parts of the IRB 920 via myABB Business Portal, www.abb.com/myABB.

Spare part	Article number	Note
Timing belt A1	3HAC070449-001	

Required tools and equipment

Equipment	Article number	Note
Standard toolkit	-	Content is defined in section Standard toolkit on page 996 .
Calibration toolbox, Axis Calibration	3HAC055412-001	Delivered as a set of calibration tools. Required if Axis Calibration is the valid calibration method for the robot.

Continues on next page

Equipment	Article number	Note
Sonic tension meter	-	Used for measuring the timing belt tension.
Handheld dynamometer	-	Used for measuring the timing belt tension.

Required consumables

Consumable	Article number	Note
Cable straps	-	
Grease	3HAC029132-001	FM 222

Deciding calibration routine

Decide which calibration routine to be used, based on the information in the table. Depending on which routine is chosen, action might be required prior to beginning the repair work of the robot, see the table.

	Action	Note
1	<p>Decide which calibration routine to use for calibrating the robot.</p> <ul style="list-style-type: none"> Reference calibration. External cable packages (DressPack) and tools can stay fitted on the robot. Fine calibration. All external cable packages (DressPack) and tools must be removed from the robot. 	
	<p>If the robot is to be calibrated with reference calibration:</p> <p>Find previous reference values for the axis or create new reference values. These values are to be used after the repair procedure is completed, for calibration of the robot.</p> <p>If no previous reference values exist, and no new reference values can be created, then reference calibration is not possible.</p>	<p>Follow the instructions given in the reference calibration routine on the FlexPendant to create reference values.</p> <p>Creating new values requires possibility to move the robot.</p> <p>Read more about reference calibration for Axis Calibration in Reference calibration routine on page 957.</p>
	<p>If the robot is to be calibrated with fine calibration:</p> <p>Remove all external cable packages (DressPack) and tools from the robot.</p>	

Removing the axis-1 timing belt

Use these procedures to remove the axis-1 timing belt.

Preparations before removing the axis-1 timing belt

Remove the robot from the wall or enough space.



	Action	Note
1	Decide which calibration routine to use, and take actions accordingly prior to beginning the repair procedure.	

Continues on next page

5 Repair

5.4.2 Replacing the axis-1 timing belt

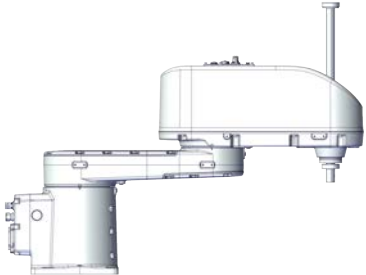

Continued

	Action	Note
2	<p>If there is no enough space for the maintenance work, remove the robot from the wall and place it on the maintenance bracket.</p> <p> CAUTION</p> <p>Do not lay down the robot during the transportation, always keep it straight. If the robot lay down in any situation, the grease may come out from gearbox.</p>	
3	<p>Jog all axes to zero position.</p>	 <p>xx2100000930</p>
4	<p> DANGER</p> <p>Turn off all:</p> <ul style="list-style-type: none"> • electric power supply • hydraulic pressure supply • air pressure supply <p>to the robot, before entering the safeguarded space.</p>	
5	<p> CAUTION</p> <p>For robots with protection type Clean Room Always cut the paint with a knife and grind the paint edge when disassembling parts of the robot! See Cut the paint or surface on the robot before replacing parts on page 118.</p>	

Removing the process hub screws

	Action	Note
1	<p> DANGER</p> <p>Make sure that all supplies for electrical power, hydraulic pressure, and air pressure are turned off.</p>	

Continues on next page

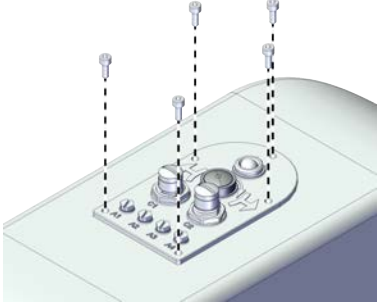
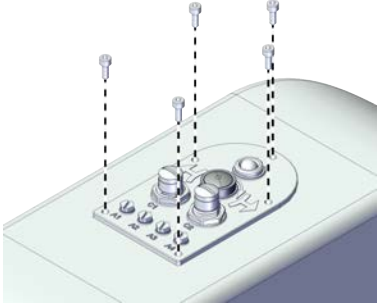
	Action	Note
2	<p> CAUTION</p> <p>For robots with protection type Clean Room Always cut the paint with a knife and grind the paint edge when disassembling parts of the robot! See <i>Cut the paint or surface on the robot before replacing parts on page 118.</i></p>	
3	<p>Remove the screws on the process hub.</p> <p> Note</p> <p>For robots with protection class IP54 (option 3350-540) For robots with protection type Clean Room (option 3351-1) Remove the screws on the process hub and take out the gasket.</p> <p> Tip</p> <p>Check the gasket and replace it if needed.</p>	<p>For robots with protection class IP30</p>  <p>xx2100000932</p> <p>For robots with protection class IP54 (option 3350-540) For robots with protection type Clean Room (option 3351-1)</p>  <p>xx2100000932</p>
4	Insert the process hub to the outer arm.	

For Clean Room/ IP54 robots

Removing the top cover and the flange with bearing



	Action	Note
1	<p> DANGER</p> <p>Make sure that all supplies for electrical power, hydraulic pressure, and air pressure are turned off.</p>	

Continues on next page

5 Repair

5.4.2 Replacing the axis-1 timing belt

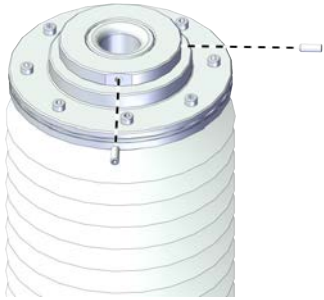

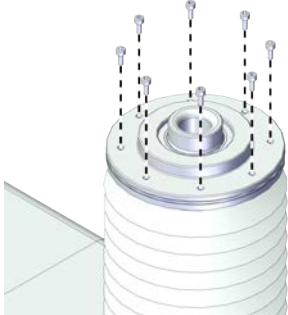
Continued

	Action	Note
2	<p> CAUTION</p> <p>For robots with protection type Clean Room Always cut the paint with a knife and grind the paint edge when disassembling parts of the robot! See <i>Cut the paint or surface on the robot before replacing parts on page 118.</i></p>	
3	<p>For robots with protection class IP54 (option 3350-540) For robots with protection type Clean Room (option 3351-1) Loose the locking screws.</p>	 <p>xx2100002398</p>
4	<p>For robots with protection class IP54 (option 3350-540) For robots with protection type Clean Room (option 3351-1) Remove the top cover from the ball screw.</p>	 <p>xx2100002399</p>
5	<p>For robots with protection class IP54 (option 3350-540) For robots with protection type Clean Room (option 3351-1) Remove the screws on the flange with bearing.</p>	 <p>xx2100002401</p>

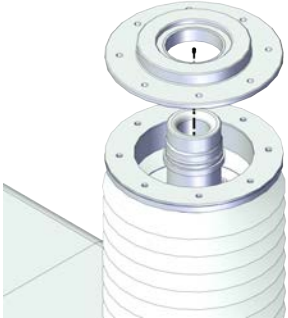
Continues on next page

	Action	Note
6	<p>For robots with protection class IP54 (option 3350-540) For robots with protection type Clean Room (option 3351-1) Remove the flange with bearing.</p>	 <p>xx2100002402</p>

Removing the cover of the outer arm



	Action	Note
1	<p> DANGER</p> <p>Make sure that all supplies for electrical power, hydraulic pressure, and air pressure are turned off.</p>	
2	<p> CAUTION</p> <p>For robots with protection type Clean Room Always cut the paint with a knife and grind the paint edge when disassembling parts of the robot! See Cut the paint or surface on the robot before replacing parts on page 118.</p>	

Continues on next page



5 Repair

5.4.2 Replacing the axis-1 timing belt

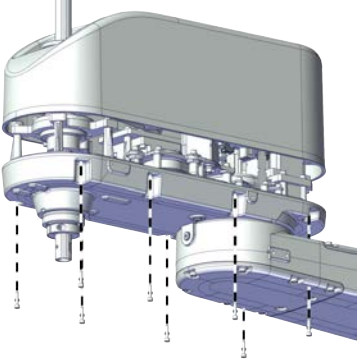
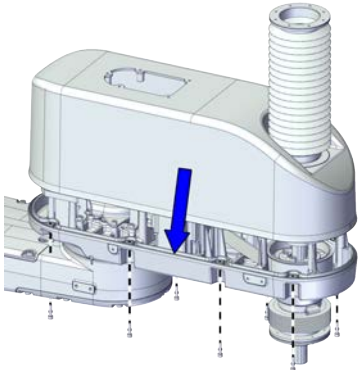



Continued

	Action	Note
3	<p>Remove the screws on the cover of the outer arm and remove the cover.</p> <p> Note</p> <p>For robots with protection class IP54 (option 3350-540) For robots with protection type Clean Room (option 3351-1) Remove the cover with bellow and housing.</p> <p> Note</p> <p>The bellow does not need to be removed separately.</p> <p> Tip</p> <p>Check the gasket and replace it if needed.</p>	<p>For robots with protection class IP30</p>  <p>xx210000933</p> <p>For robots with protection class IP54 (option 3350-540) For robots with protection type Clean Room (option 3351-1)</p>  <p>xx2100002427</p>

Disconnecting the air hoses, C1 cabling and C2 cabling (if equipped)

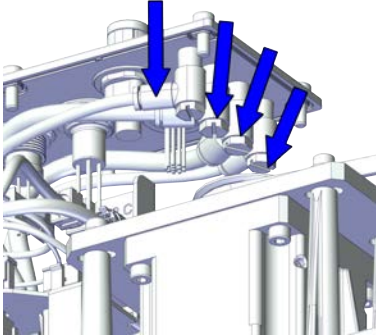
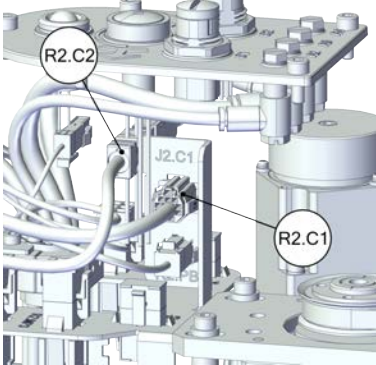
	Action	Note
1	<p> DANGER</p> <p>Make sure that all supplies for electrical power, hydraulic pressure, and air pressure are turned off.</p>	
2	<p> CAUTION</p> <p>For robots with protection type Clean Room Always cut the paint with a knife and grind the paint edge when disassembling parts of the robot! See Cut the paint or surface on the robot before replacing parts on page 118.</p>	

Continues on next page

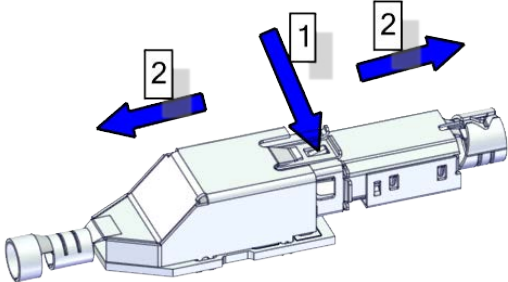
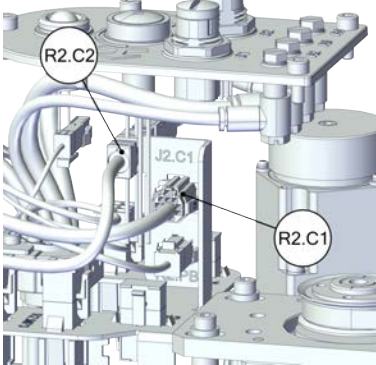
	Action	Note
3	<p>Disconnect the air hoses from the L-shaped connectors.</p>	 <p>xx2100001032</p>
4	<p>For robots with C1 cabling Disconnect the connector.</p> <ul style="list-style-type: none"> • R2.C1 	 <p>xx2100001033</p>
5	<p>For robots with C2 cabling Disconnect the connector.</p> <ul style="list-style-type: none"> • R1.C2 <p> Tip</p> <p>Cut the cable straps for the R1.C2 at the same time.</p> <p> Tip</p> <p>Take photos of the connector and cable position before disconnecting them, to have as a reference when reconnecting.</p> <p> Tip</p> <p>The connector clip has to be pressed (1) and pushed forward (2) to separate the R1.C2 (for C2 cabling).</p>  <p>xx1800002943</p>	 <p>xx2100001033</p>

Continues on next page



5 Repair

5.4.2 Replacing the axis-1 timing belt

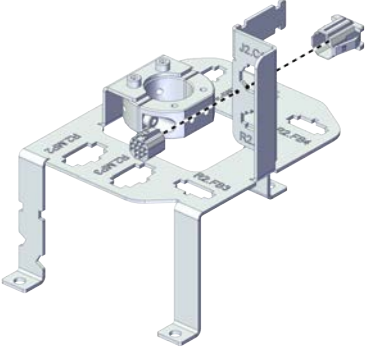
Continued

	Action	Note
6	<p>Snap loose and remove the female head of the connectors from the bracket.</p> <p> Note</p> <p>The harness are not visible due to the cleanness requirements of the illustration. They are still existing inside the cable ferrule in the actual situation.</p>	 <p>xx2100001034</p>

Disconnecting the connectors for axis-2 motor

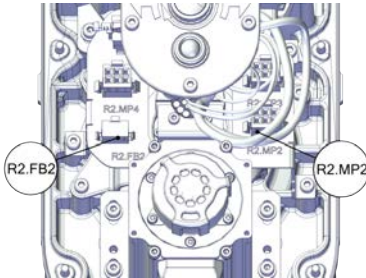

	Action	Note
1	<p> DANGER</p> <p>Make sure that all supplies for electrical power, hydraulic pressure, and air pressure are turned off.</p>	
2	<p> CAUTION</p> <p>For robots with protection type Clean Room Always cut the paint with a knife and grind the paint edge when disassembling parts of the robot! See Cut the paint or surface on the robot before replacing parts on page 118.</p>	
3	<p>Disconnect the connectors.</p> <ul style="list-style-type: none"> • R2.MP2 • R2.FB2 	 <p>xx2100000934</p>

Continues on next page

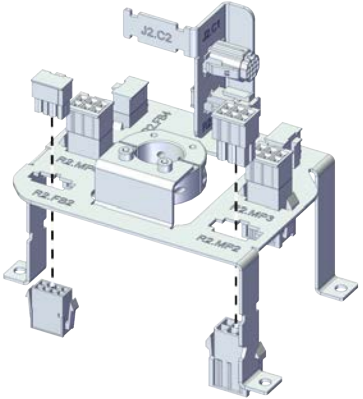
5.4.2 Replacing the axis-1 timing belt
Continued

	Action	Note
4	<p>Snap loose and remove the female head of the connectors from the bracket.</p> <p> Note</p> <p>The harness are not visible due to the cleanness requirements of the illustration. They are still existing inside the cable ferrule in the actual situation.</p>	 <p>xx2100000935</p>

Disconnecting the connectors for axis-3 motor

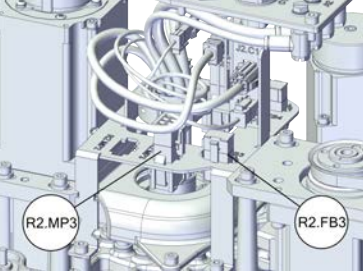
	Action	Note
1	<p> DANGER</p> <p>Make sure that all supplies for electrical power, hydraulic pressure, and air pressure are turned off.</p>	
2	<p> CAUTION</p> <p>For robots with protection type Clean Room</p> <p>Always cut the paint with a knife and grind the paint edge when disassembling parts of the robot! See Cut the paint or surface on the robot before replacing parts on page 118.</p>	
3	<p>Disconnect the connectors.</p> <ul style="list-style-type: none"> • R2.MP3 • R2.FB3 	 <p>xx2100000936</p>

Continues on next page



5 Repair

5.4.2 Replacing the axis-1 timing belt

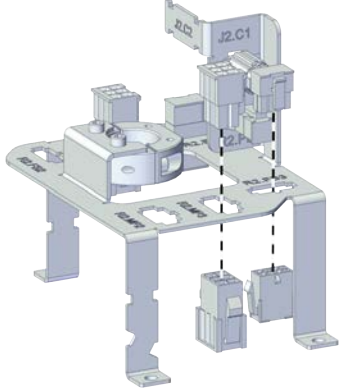
Continued



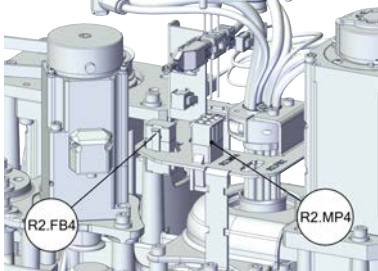

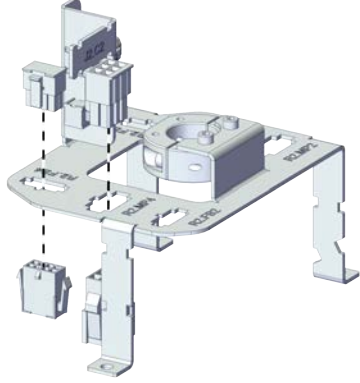
	Action	Note
4	<p>Snap loose and remove the female head of the connectors from the bracket.</p> <p> Note</p> <p>The harness are not visible due to the cleanness requirements of the illustration. They are still existing inside the cable ferrule in the actual situation.</p>	 <p>xx2100000937</p>

Disconnecting the connectors for axis-4 motor

	Action	Note
1	<p>For robots with protection type Clean Room: Clean the joints that have been opened and wipe the parts free from particles with spirit on a lint free. See Cut the paint or surface on the robot before replacing parts on page 118</p> <p> Note</p> <p>After all repair work, wipe the Clean Room robot free from particles with spirit on a lint free cloth.</p>	
2	<p>Disconnect the axis-4 motor connectors.</p> <ul style="list-style-type: none"> • R2.MP4 • R2.FB4 	 <p>xx2100000938</p>
3	<p>Snap loose and remove the female head of the connectors from the bracket.</p> <p> Note</p> <p>The harness are not visible due to the cleanness requirements of the illustration. They are still existing inside the cable ferrule in the actual situation.</p>	 <p>xx2100000939</p>

Continues on next page

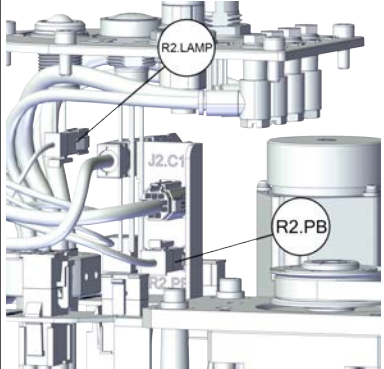
Disconnecting the connector for PB

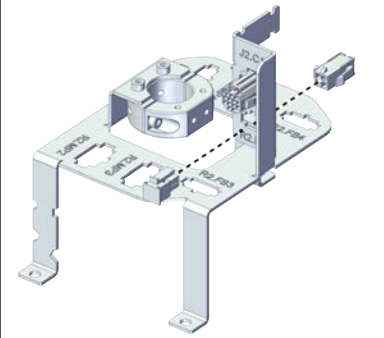
	Action	Note
1	 DANGER Make sure that all supplies for electrical power, hydraulic pressure, and air pressure are turned off.	
2	 CAUTION For robots with protection type Clean Room Always cut the paint with a knife and grind the paint edge when disassembling parts of the robot! See Cut the paint or surface on the robot before replacing parts on page 118 .	
3	Disconnect the connector. <ul style="list-style-type: none"> • R2.PB • R2.LAMP 	 <p>xx2100001030</p>
4	Snap loose and remove the female head of the connector from the bracket.  Note The harness are not visible due to the cleanliness requirements of the illustration. They are still existing inside the cable ferrule in the actual situation.	 <p>xx2100001031</p>

Pull out the process hub





	Action	Note
1	 DANGER Make sure that all supplies for electrical power, hydraulic pressure, and air pressure are turned off.	

Continues on next page



5 Repair

5.4.2 Replacing the axis-1 timing belt

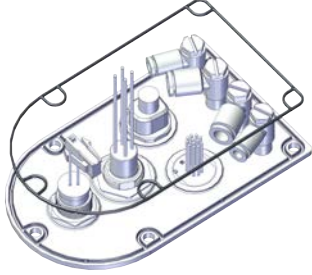

Continued

	Action	Note
2	 CAUTION For robots with protection type Clean Room Always cut the paint with a knife and grind the paint edge when disassembling parts of the robot! See Cut the paint or surface on the robot before replacing parts on page 118 .	
3	Take out the process hub.  Note For robots with protection class IP54 (option 3350-540) For robots with protection type Clean Room (option 3351-1) Check the gasket for the process hub.  Tip Replace the gasket if needed.  CAUTION Be aware of the cabling that is attached to the cover! The cover can not be removed completely until the connectors are disconnected, as shown in following steps.	For robots with protection class IP54 (option 3350-540) For robots with protection type Clean Room (option 3351-1)  xx2100002438

Removing the cable ferrule and bracket

	Action	Note
1	 DANGER Make sure that all supplies for electrical power, hydraulic pressure, and air pressure are turned off.	
2	 CAUTION For robots with protection type Clean Room Always cut the paint with a knife and grind the paint edge when disassembling parts of the robot! See Cut the paint or surface on the robot before replacing parts on page 118 .	

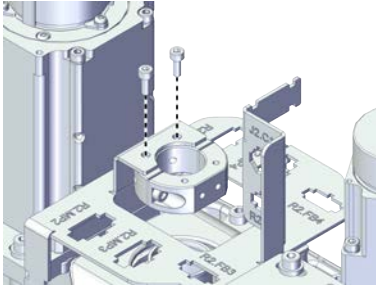
Continues on next page

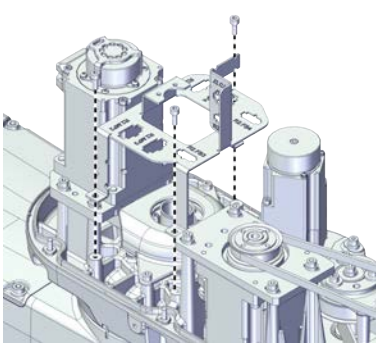
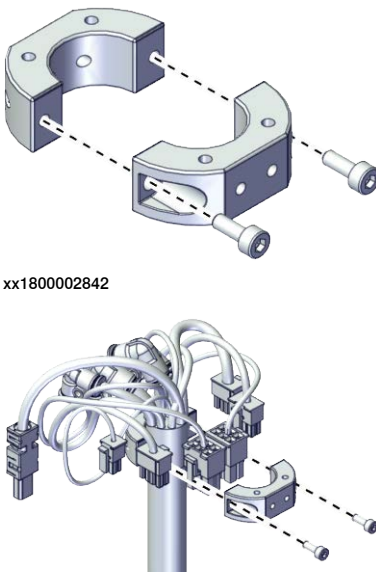
	Action	Note
3	<p>Remove the screws on the bracket to the cable ferrule to release the cable ferrule with cable.</p> <p> Note</p> <p>The harness are not visible due to the cleanness requirements of the illustration. They are still existing inside the cable ferrule in the actual situation.</p>	 <p>xx2100000940</p>
4	<p>Remove the screws on the bracket.</p> <p> Note</p> <p>The harness are not visible due to the cleanness requirements of the illustration. They are still existing inside the cable ferrule in the actual situation.</p>	 <p>xx2100000941</p>
5	<p>Remove the screws on the cable ferrule and take the cable ferrule out.</p>	 <p>xx1800002842</p> <p>xx1800002849</p>

Removing the axis-1 cover



	Action	Note
1	<p> DANGER</p> <p>Make sure that all supplies for electrical power, hydraulic pressure, and air pressure are turned off.</p>	

Continues on next page



5 Repair

5.4.2 Replacing the axis-1 timing belt

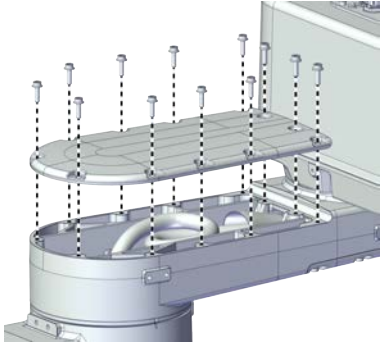
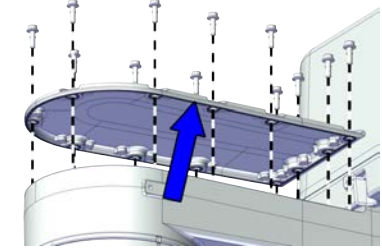

Continued

	Action	Note
2	 CAUTION For robots with protection type Clean Room Always cut the paint with a knife and grind the paint edge when disassembling parts of the robot! See Cut the paint or surface on the robot before replacing parts on page 118 .	
3	Remove the screws.	For robots with protection class IP30 (option 3350-300)
4	Remove the cover.  Note For robots with protection class IP54 (option 3350-540) For robots with protection type Clean Room (option 3351-1) Remove the cover and check the gasket.  Tip Replace the gasket if needed.	 <p>xx2100000942</p>  <p>xx2100002428</p>



Removing the axis-2 cover

	Action	Note
1	 DANGER Make sure that all supplies for electrical power, hydraulic pressure, and air pressure are turned off.	
2	 CAUTION For robots with protection type Clean Room Always cut the paint with a knife and grind the paint edge when disassembling parts of the robot! See Cut the paint or surface on the robot before replacing parts on page 118 .	

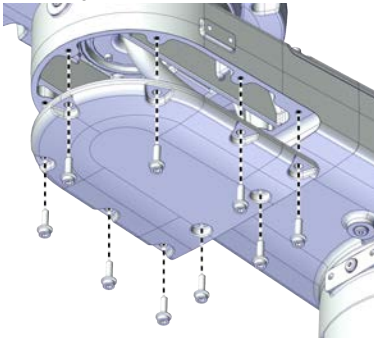
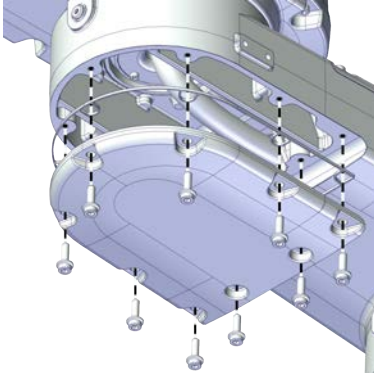
Continues on next page

	Action	Note
3	Remove the screws.	For robots with protection class IP30 (option 3350-300)
4	Remove the cover.  Note For robots with protection class IP54 (option 3350-540) For robots with protection type Clean Room (option 3351-1) Remove the cover and check the gasket.  Tip Replace the gasket if needed.	 xx2100000943 For robots with protection class IP54 (option 3350-540) For robots with protection type Clean Room (option 3351-1)  xx2100002451

Removing the SMB cover





	Action	Note
1	 DANGER Make sure that all supplies for electrical power, hydraulic pressure, and air pressure are turned off.	
2	 ELECTROSTATIC DISCHARGE (ESD) The unit is sensitive to ESD. Before handling the unit read the safety information in section The unit is sensitive to ESD on page 49 .	

Continues on next page

5 Repair

5.4.2 Replacing the axis-1 timing belt

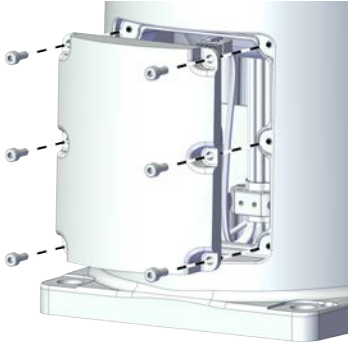

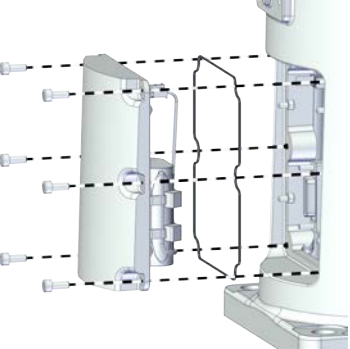
Continued

	Action	Note
3	 CAUTION For robots with protection type Clean Room Always cut the paint with a knife and grind the paint edge when disassembling parts of the robot! See Cut the paint or surface on the robot before replacing parts on page 118 .	
4	Remove the screws on the SMB cover to the base.  Note For robots with protection type Clean Room (option 3351-1) Remove the stainless screws on the SMB cover to the base.	For robots with protection class IP30 (option 3350-300) 
5	Pull the SMB cover with the SMB unit assembly out together.  Note For robots with protection class IP54 (option 3350-540) For robots with protection type Clean Room (option 3351-1) Check the gasket for the SMB cover.  Tip Replace the gasket if needed.	xx210000944 For robots with protection class IP54 (option 3350-540) For robots with protection type Clean Room (option 3351-1)  xx2100002433



Disconnecting the SMB cabling

	Action	Note
1	 DANGER Make sure that all supplies for electrical power, hydraulic pressure, and air pressure are turned off.	

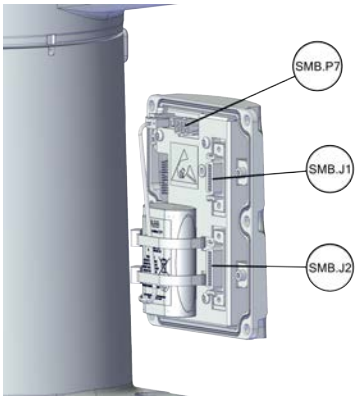
Continues on next page

	Action	Note
2	 ELECTROSTATIC DISCHARGE (ESD) The unit is sensitive to ESD. Before handling the unit read the safety information in section The unit is sensitive to ESD on page 49 .	
3	 CAUTION For robots with protection type Clean Room Always cut the paint with a knife and grind the paint edge when disassembling parts of the robot! See Cut the paint or surface on the robot before replacing parts on page 118 .	
4	Cut the strips.	
5	Disconnect the connectors. <ul style="list-style-type: none"> • SMB.P7 • SMB.J1 • SMB.J2  Tip Take photos of the connector and cable position before disconnecting them, to have as a reference when reconnecting.	 <p>xx2100000945</p>

Removing the base plate/ rear plate



	Action	Note
1	 DANGER Make sure that all supplies for electrical power, hydraulic pressure, and air pressure are turned off.	
2	 CAUTION For robots with protection type Clean Room Always cut the paint with a knife and grind the paint edge when disassembling parts of the robot! See Cut the paint or surface on the robot before replacing parts on page 118 .	
3	Remove the screws on the base to the ground.	
4	Lay down the robot.	

Continues on next page



5 Repair

5.4.2 Replacing the axis-1 timing belt

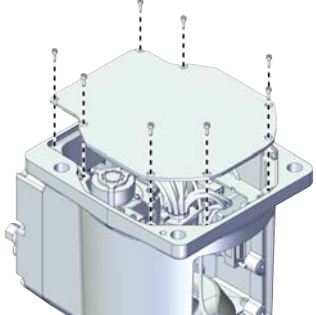
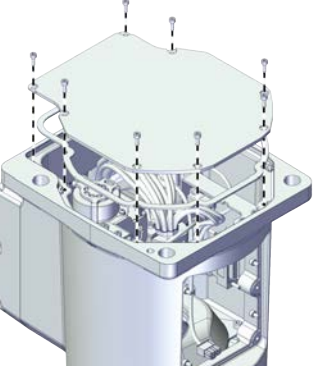

Continued

	Action	Note
5	For robot with rear outlet cable version, remove the screws on the base plate.	For rear outlet cable version:
6	<p>Remove the base plate.</p> <p> Note</p> <p>For robots with protection class IP54 (option 3350-540)</p> <p>For robots with protection type Clean Room (option 3351-1)</p> <p>Check the gasket for the base plate.</p> <p> Tip</p> <p>Replace the gasket if needed.</p>	<p>For robots with protection class IP30 (option 3350-300)</p>  <p>xx210000946</p> <p>For robots with protection class IP54 (option 3350-540)</p> <p>For robots with protection type Clean Room (option 3351-1)</p>  <p>xx2100002434</p>

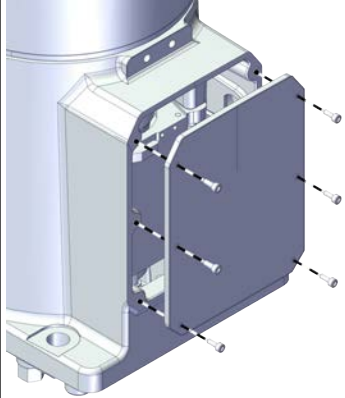
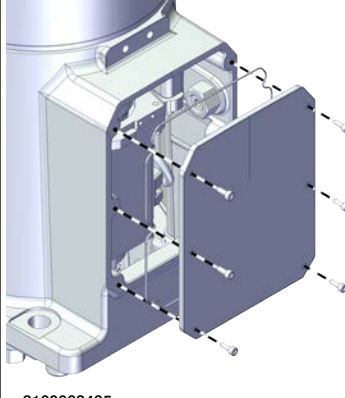
Continues on next page

	Action	Note
7	For robot with underneath outlet cable version, remove the screws on the rear plate.	For underneath outlet cable version:
8	<p>Remove the rear plate.</p> <p> Note</p> <p>For robots with protection class IP54 (option 3350-540)</p> <p>For robots with protection type Clean Room (option 3351-1)</p> <p>Check the gasket for the rear plate.</p> <p> Tip</p> <p>Replace the gasket if needed.</p>	<p>For robots with protection class IP30 (option 3350-300)</p>  <p>xx2100001202</p> <p>For robots with protection class IP54 (option 3350-540)</p> <p>For robots with protection type Clean Room (option 3351-1)</p>  <p>xx2100002435</p>

Releasing the base bracket

	Action	Note
1	<p> DANGER</p> <p>Make sure that all supplies for electrical power, hydraulic pressure, and air pressure are turned off.</p>	
2	<p> CAUTION</p> <p>For robots with protection type Clean Room</p> <p>Always cut the paint with a knife and grind the paint edge when disassembling parts of the robot!</p> <p>See Cut the paint or surface on the robot before replacing parts on page 118.</p>	

Continues on next page



5 Repair

5.4.2 Replacing the axis-1 timing belt

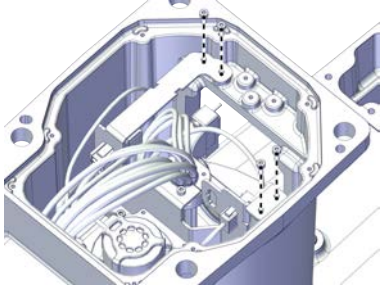
Continued

	Action	Note
3	Remove the screws on the base bracket to the base.	 <p>xx2100000948</p>

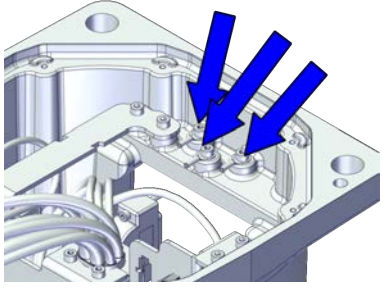

Disconnecting the grounding cable connectors

	Action	Note
1	 DANGER Make sure that all supplies for electrical power, hydraulic pressure, and air pressure are turned off.	
2	 CAUTION For robots with protection type Clean Room Always cut the paint with a knife and grind the paint edge when disassembling parts of the robot! See Cut the paint or surface on the robot before replacing parts on page 118 .	
3	Remove the three grounding cables from the bracket by unscrew the screws.	 <p>xx2100000947</p>

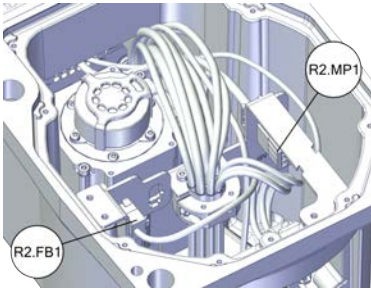

Disconnecting the connectors for axis-1 motor

	Action	Note
1	 DANGER Make sure that all supplies for electrical power, hydraulic pressure, and air pressure are turned off.	

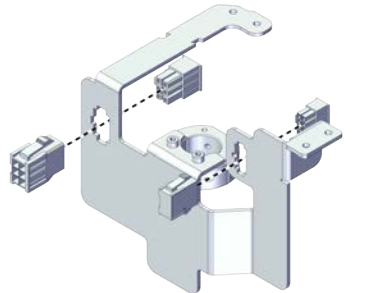
Continues on next page

	Action	Note
2	 CAUTION For robots with protection type Clean Room Always cut the paint with a knife and grind the paint edge when disassembling parts of the robot! See <i>Cut the paint or surface on the robot before replacing parts on page 118.</i>	
3	Disconnect the connectors. <ul style="list-style-type: none"> • R2.MP1 • R2.FB1 	 xx2100000949
4	Snap loose and remove the female head of the connectors from the bracket.  Note The harness are not visible due to the cleanness requirements of the illustration. They are still existing inside the cable ferrule in the actual situation.	 xx2100000950

Removing the bracket

	Action	Note
1	 DANGER Make sure that all supplies for electrical power, hydraulic pressure, and air pressure are turned off.	
2	 CAUTION For robots with protection type Clean Room Always cut the paint with a knife and grind the paint edge when disassembling parts of the robot! See <i>Cut the paint or surface on the robot before replacing parts on page 118.</i>	

Continues on next page



5 Repair

5.4.2 Replacing the axis-1 timing belt

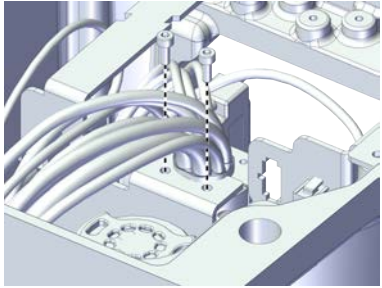
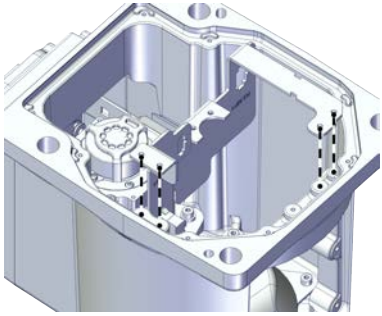
Continued



	Action	Note
3	Release the cable ferrule from the bracket.	 xx2100000951
4	Remove the bracket.	 xx2100000952

Removing the main harness from the axis -2 gearbox position



	Action	Note
1	 DANGER Make sure that all supplies for electrical power, hydraulic pressure, and air pressure are turned off.	
2	 CAUTION For robots with protection type Clean Room Always cut the paint with a knife and grind the paint edge when disassembling parts of the robot! See Cut the paint or surface on the robot before replacing parts on page 118 .	

Continues on next page

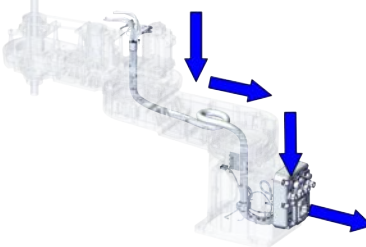
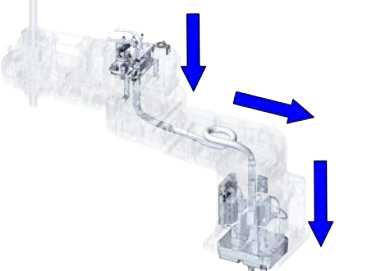
5.4.2 Replacing the axis-1 timing belt
Continued

	Action	Note
3	<p>Pull the internal harness out of the outer arm from the centre of the axis-2 gearbox.</p> <p> Tip Wrap the connectors with the masking tape.</p> <p> Tip Take photos of the connector and cable position before disconnecting them, to have as a reference when reconnecting.</p>	<p>For rear outlet cable version:</p>  <p>xx2100000954</p> <p>For underneath outlet cable version:</p>  <p>xx2100001203</p>

Removing the main harness from the axis -1 gearbox position

	Action	Note
1	<p> DANGER</p> <p>Make sure that all supplies for electrical power, hydraulic pressure, and air pressure are turned off.</p>	
2	<p> CAUTION</p> <p>For robots with protection type Clean Room Always cut the paint with a knife and grind the paint edge when disassembling parts of the robot! See Cut the paint or surface on the robot before replacing parts on page 118.</p>	

Continues on next page



5 Repair

5.4.2 Replacing the axis-1 timing belt

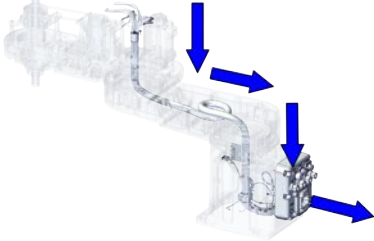
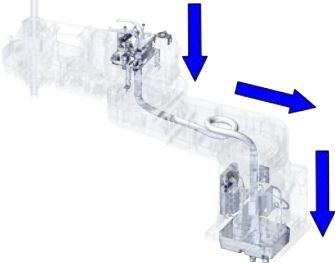

Continued

	Action	Note
3	<p>Pull the internal harness out of the inner arm from the sleeve of the axis-1 gearbox.</p> <p> Tip</p> <p>Wrap the connectors with the masking tape.</p>	<p>For rear outlet cable version:</p>  <p>xx2100000954</p> <p>For underneath outlet cable version:</p>  <p>xx2100001203</p>

Removing the main harness

	Action	Note
1	<p> DANGER</p> <p>Make sure that all supplies for electrical power, hydraulic pressure, and air pressure are turned off.</p>	
2	<p> CAUTION</p> <p>For robots with protection type Clean Room</p> <p>Always cut the paint with a knife and grind the paint edge when disassembling parts of the robot!</p> <p>See Cut the paint or surface on the robot before replacing parts on page 118.</p>	

Continues on next page

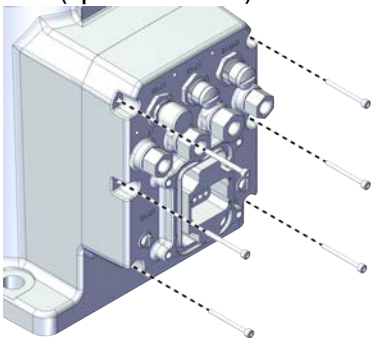
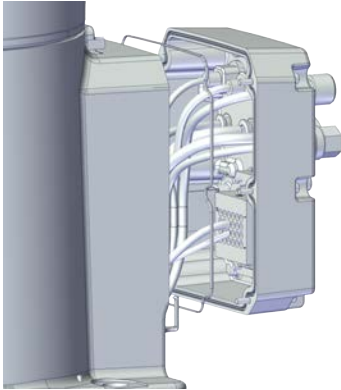

	Action	Note
3	For robot with rear outlet cable version, remove the screws on the main harness to the base.	For rear outlet cable version:
4	<p>Remove the main harness.</p> <p> Note</p> <p>For robots with protection class IP54 (option 3350-540)</p> <p>For robots with protection type Clean Room (option 3351-1)</p> <p>Check the gasket for the main harness.</p> <p> Tip</p> <p>Replace the gasket if needed.</p>	<p>For robots with protection class IP30 (option 3350-300)</p>  <p>xx2100000953</p> <p>For robots with protection class IP54 (option 3350-540)</p> <p>For robots with protection type Clean Room (option 3351-1)</p>  <p>xx2100002436</p>

Continues on next page

5 Repair

5.4.2 Replacing the axis-1 timing belt

Continued

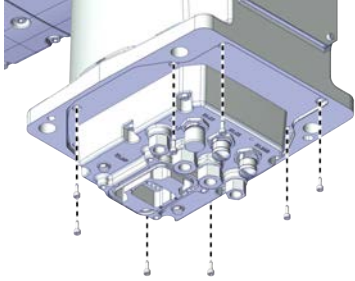
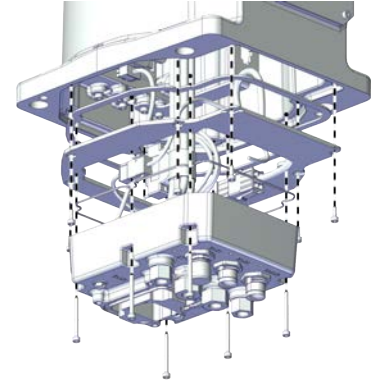
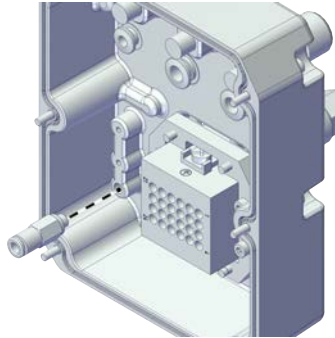
	Action	Note
5	For robot with underneath outlet cable version, remove the screws on the main harness assembly.	For underneath outlet cable version:
6	<p>Remove the main harness assembly.</p> <p> Note</p> <p>For robots with protection class IP54 (option 3350-540)</p> <p>For robots with protection type Clean Room (option 3351-1)</p> <p>Check the gasket for the main harness assembly.</p> <p> Tip</p> <p>Replace the gasket if needed.</p> <p> Note</p> <p>Remove the bottom plate from the main harness if needed.</p>	<p>For robots with protection class IP30 (option 3350-300)</p>  <p>xx2100001204</p> <p>For robots with protection class IP54 (option 3350-540)</p> <p>For robots with protection type Clean Room (option 3351-1)</p>  <p>xx2100002437</p>
7	<p>For robots with protection type Clean Room (option 3351-1)</p> <p>Remove the one way valve by unscrewing it.</p>	 <p>xx2200000281</p>



Removing the pulley protection cover

	Action	Note
1	<p> DANGER</p> <p>Make sure that all supplies for electrical power, hydraulic pressure, and air pressure are turned off.</p>	

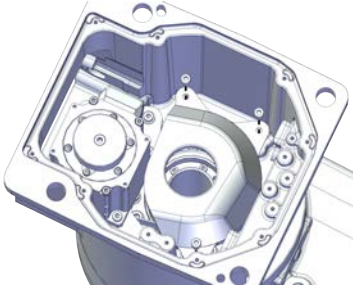
Continues on next page

	Action	Note
2	<p> CAUTION</p> <p>For robots with protection type Clean Room Always cut the paint with a knife and grind the paint edge when disassembling parts of the robot! See Cut the paint or surface on the robot before replacing parts on page 118.</p>	
3	Remove the screws on the pulley protection cover to the base.	 <p>xx2100001037</p>
4	Remove the pulley protection cover.	

Removing the axis-1 motor sub-assembly

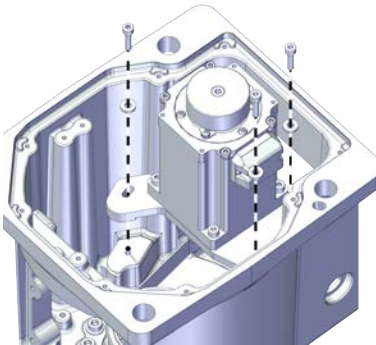
	Action	Note
1	<p> DANGER</p> <p>Make sure that all supplies for electrical power, hydraulic pressure, and air pressure are turned off.</p>	
2	<p> CAUTION</p> <p>For robots with protection type Clean Room Always cut the paint with a knife and grind the paint edge when disassembling parts of the robot! See Cut the paint or surface on the robot before replacing parts on page 118.</p>	
3	Remove the screws and washers.	 <p>xx2100001038</p>
4	Remove the motor.	



Continues on next page

5 Repair

5.4.2 Replacing the axis-1 timing belt

Continued

Removing the axis-1 timing belt

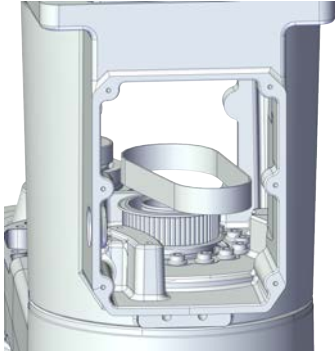
	Action	Note
1	 DANGER Make sure that all supplies for electrical power, hydraulic pressure, and air pressure are turned off.	
2	 CAUTION For robots with protection type Clean Room Always cut the paint with a knife and grind the paint edge when disassembling parts of the robot! See Cut the paint or surface on the robot before replacing parts on page 118 .	
3	Take the timing belt out carefully.	 <small>xx2100001045</small>



Refitting the axis-1 timing belt

Use these procedures to refit the axis-1 timing belt.

Refitting the axis-1 motor sub-assembly

	Action	Note
1	For robots with protection type Clean Room: Clean the joints that have been opened and wipe the parts free from particles with spirit on a lint free. See Cut the paint or surface on the robot before replacing parts on page 118  Note After all repair work, wipe the Clean Room robot free from particles with spirit on a lint free cloth.	
2	Put the timing belt into the pulley on the gear.	

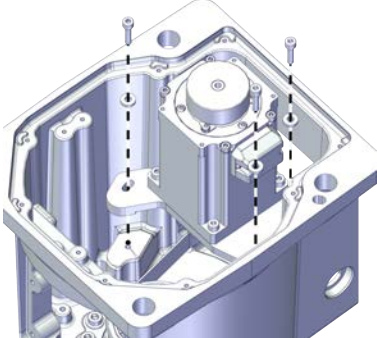
Continues on next page

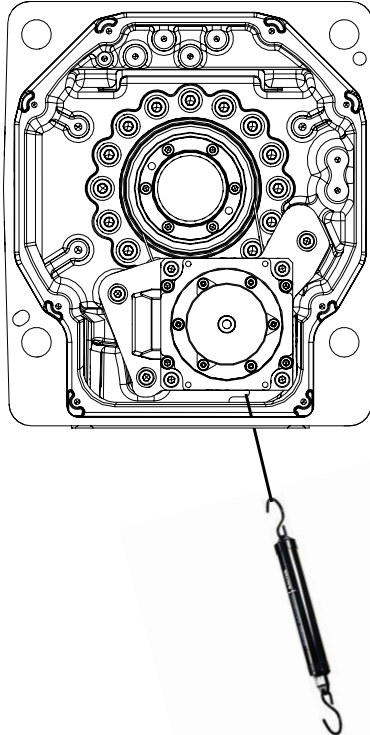
	Action	Note
3	<p>Refit the motor and refit the timing belt to the motor. Ensure that the belt runs correctly in the grooves.</p>	<p>Screws: Hex socket head cap screw M4x16 12.9 Lafre 2C2B/FC6.9 (3 pcs)</p>
4	<p>Refit the screws and washers without fully tightened.</p>	<p>Washers: Plain washer machining 4.2x9x2 steel (3 pcs) Tightening torque: 2.8 Nm ±10%</p>  <p>xx2100001038</p> <p>Timing belt A1: 3HAC070449-001</p>
5	<p>Hang a strap to the hook on the motor.</p>	
6	<p>Use a handheld dynamometer hooking to the strap and pull the dynamometer to make the tension falling in the allowed force range.</p> <p> Note</p> <p>During the measurement, make sure that all interferences that may affect the force are removed. Pay attention to the force application direction.</p>	<p>Used belt: 51.1 New belt:90</p>  <p>xx2100001043</p>

Continues on next page



5 Repair

5.4.2 Replacing the axis-1 timing belt

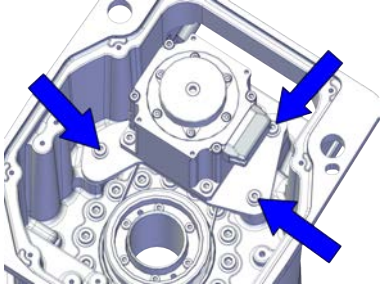
Continued



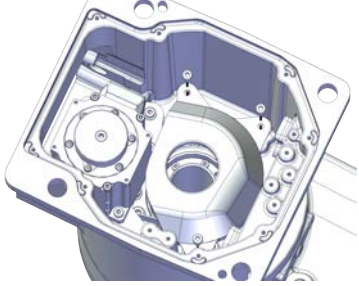

	Action	Note
7	Fasten the screws to the recommended tightening torque.	Tightening torque: 2.8 Nm \pm 10%  xx2100001044
8	Use a sonic tension meter to measure the timing belt tension.	Used belt: 308 New belt:250
9	If the timing belt tension does not meet the requirement, loosen the motor screws and readjust.	

Refitting the pulley protection cover

	Action	Note
1	 DANGER Make sure that all supplies for electrical power, hydraulic pressure, and air pressure are turned off.	
2	 CAUTION For robots with protection type Clean Room Always cut the paint with a knife and grind the paint edge when disassembling parts of the robot! See Cut the paint or surface on the robot before replacing parts on page 118 .	
3	Refit the pulley protection cover.	Screws: Hex socket head cap screw M4x10 12.9 Lafre 2C2B/FC6.9 (8 pcs) Tightening torque: 0.8 Nm  xx2100001037
4	Secure the screws on the pulley protection cover to the base.	

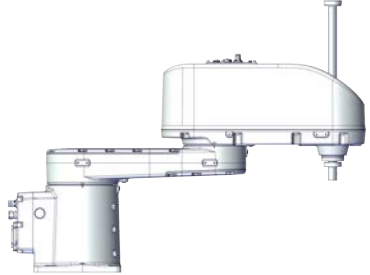
Continues on next page

Inserting the main harness through the axis -1 gearbox position

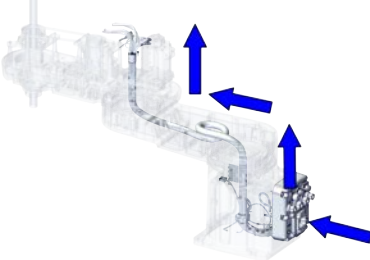
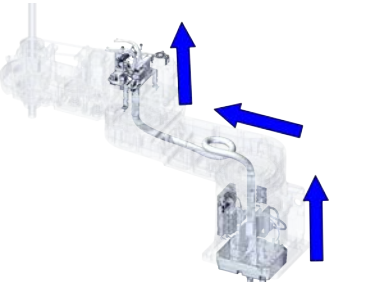
	Action	Note
1	<p>For robots with protection type Clean Room: Clean the joints that have been opened and wipe the parts free from particles with spirit on a lint free. See Cut the paint or surface on the robot before replacing parts on page 118</p> <p> Note</p> <p>After all repair work, wipe the Clean Room robot free from particles with spirit on a lint free cloth.</p>	
2	<p>Make sure that the robot is at zero position.</p>	 <p>xx2100000930</p>
3	<p>Insert the internal harness into the inner arm through the sleeve of the axis-1 gearbox from the base.</p> <p> Tip</p> <p>Wrap the connectors with the masking tape.</p> <p> Tip</p> <p>The air hoses should face the axis-1 motor.</p> <p> CAUTION</p> <p>Make sure that no cables or hoses are twisted or strained. Reroute if necessary.</p>	<p>For rear outlet cable version:</p>  <p>xx2100000955</p> <p>For underneath outlet cable version:</p>  <p>xx2100001206</p>



Continues on next page

5 Repair

5.4.2 Replacing the axis-1 timing belt

Continued



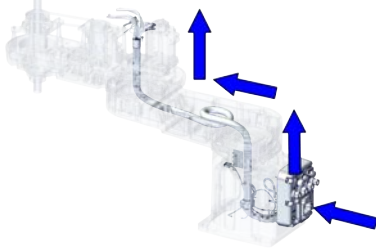
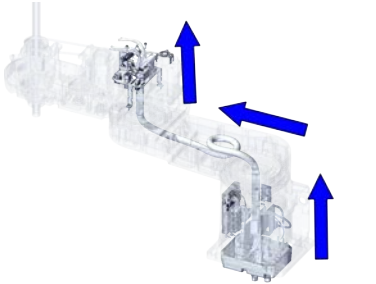



Inserting the main harness through the axis -2 gearbox position

	Action	Note
1	<p>For robots with protection type Clean Room: Clean the joints that have been opened and wipe the parts free from particles with spirit on a lint free. See Cut the paint or surface on the robot before replacing parts on page 118</p> <p> Note</p> <p>After all repair work, wipe the Clean Room robot free from particles with spirit on a lint free cloth.</p>	
2	<p>Insert the internal harness into the outer arm through the plastic protection tube and the centre of the axis-2 gearbox.</p> <p> Tip</p> <p>Wrap the connectors with the masking tape.</p>	<p>For rear outlet cable version:</p>  <p>xx2100000955</p> <p>For underneath outlet cable version:</p>  <p>xx2100001206</p>
3	Secure the R2.MP3 and R2.MP4 with cable straps.	

Reconnecting the connectors for axis-1 motor

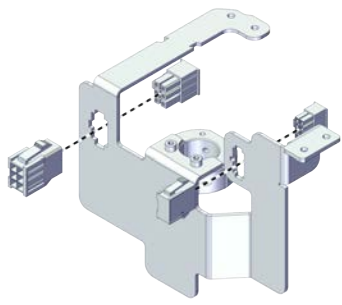
	Action	Note
1	<p>For robots with protection type Clean Room: Clean the joints that have been opened and wipe the parts free from particles with spirit on a lint free. See Cut the paint or surface on the robot before replacing parts on page 118</p> <p> Note</p> <p>After all repair work, wipe the Clean Room robot free from particles with spirit on a lint free cloth.</p>	

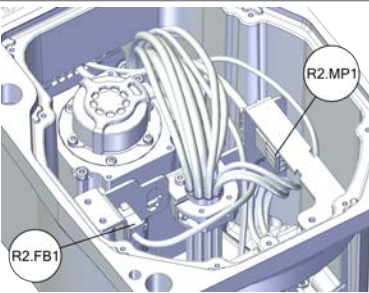
Continues on next page

	Action	Note
2	<p>Insert the female head of the connectors to the bracket accordingly.</p> <p> Tip</p> <p>The mistake proofing measure has been applied to the connectors, the connectors may be damaged if excessive force is used.</p> <p> Note</p> <p>The harness are not visible due to the cleanness requirements of the illustration. They are still existing inside the cable ferrule in the actual situation.</p>	 <p>xx2100000950</p>
3	<p>Reconnect the connectors.</p> <ul style="list-style-type: none"> • R2.MP1 • R2.FB1 <p> Tip</p> <p>See the number markings on the connectors for help to find the corresponding connector.</p>	 <p>xx2100000949</p>
4	<p>Route the cabling behind the axis-1 motor.</p> <p> CAUTION</p> <p>Correct cable routing is highly important. If the cables are routed and secured incorrectly the cables can be damaged.</p>	

Reconnecting the grounding cable connectors



	Action	Note
1	<p>For robots with protection type Clean Room: Clean the joints that have been opened and wipe the parts free from particles with spirit on a lint free. See Cut the paint or surface on the robot before replacing parts on page 118</p> <p> Note</p> <p>After all repair work, wipe the Clean Room robot free from particles with spirit on a lint free cloth.</p>	

Continues on next page

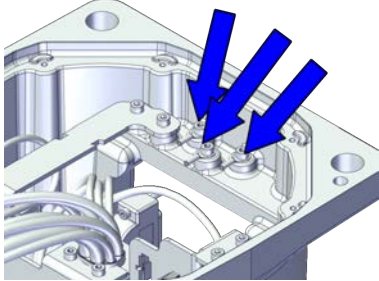

5 Repair

5.4.2 Replacing the axis-1 timing belt

Continued



	Action	Note
2	Secure the three grounding cables to the bracket with the screw.	<p>Screws: Hex socket head cap screw M3x5 12.9 Lafre 2C2B/FC6.9 (3 pcs) Tightening torque: 1.5 Nm \pm10%</p>  <p>xx2100000947</p>
3	<p>Route and secure the cabling with cable straps if needed.</p> <p> CAUTION</p> <p>Correct cable routing is highly important. If the cables are routed and secured incorrectly the cables can be damaged.</p>	

Refitting the base bracket

	Action	Note
1	<p> DANGER</p> <p>Make sure that all supplies for electrical power, hydraulic pressure, and air pressure are turned off.</p>	
2	<p> CAUTION</p> <p>For robots with protection type Clean Room Always cut the paint with a knife and grind the paint edge when disassembling parts of the robot! See Cut the paint or surface on the robot before replacing parts on page 118.</p>	
3	Lay the main harness in a natural state without distortion.	

Continues on next page

5.4.2 Replacing the axis-1 timing belt
Continued

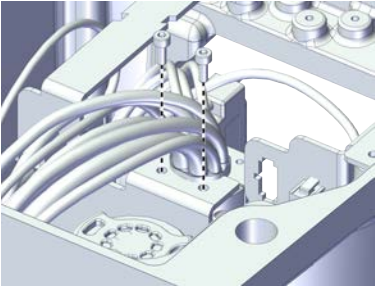
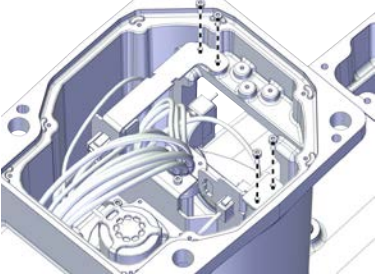
	Action	Note
	<p>Secure the cable ferrule to the bracket.</p> <p> Tip</p> <p>Align all the cable ferrules so that the cable is in a natural bending position to avoid twisting.</p> <p> Note</p> <p>The harness are not visible due to the cleanness requirements of the illustration. They are still existing inside the cable ferrule in the actual situation.</p>	<p>Screws: Hex socket head cap screw M3x8 12.9 Lafre 2C2B/FC6.9 (2 pcs)</p> <p>Tightening torque: 1.2 Nm ±10%</p>  <p>xx2100000951</p>
4	<p>Refit the base bracket to the base and secure with the screws.</p>	<p>Screws: Hex socket head cap screw M3x8 12.9 Lafre 2C2B/FC6.9 (4 pcs)</p> <p>Tightening torque: 1.2 Nm ±10%</p>  <p>xx2100000948</p>

Refitting the SMB cover

	Action	Note
1	<p>For robots with protection type Clean Room: Clean the joints that have been opened and wipe the parts free from particles with spirit on a lint free. See Cut the paint or surface on the robot before replacing parts on page 118</p> <p> Note</p> <p>After all repair work, wipe the Clean Room robot free from particles with spirit on a lint free cloth.</p>	

Continues on next page

5 Repair

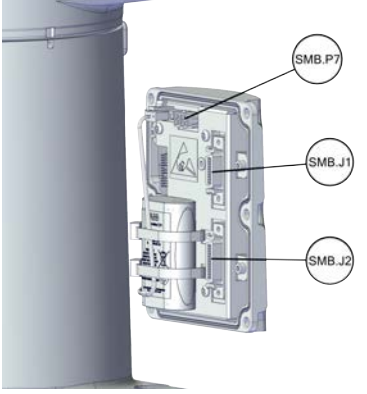

5.4.2 Replacing the axis-1 timing belt

Continued

	Action	Note
2	<p>Reconnect the connectors.</p> <ul style="list-style-type: none">• SMB.P7• SMB.J1• SMB.J2 <p> Tip</p> <p>Take photos of the connector and cable position before disconnecting them, to have as a reference when reconnecting.</p>	 <p>xx2100000945</p>

Continues on next page

5.4.2 Replacing the axis-1 timing belt
Continued

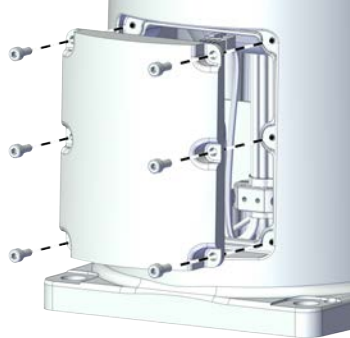
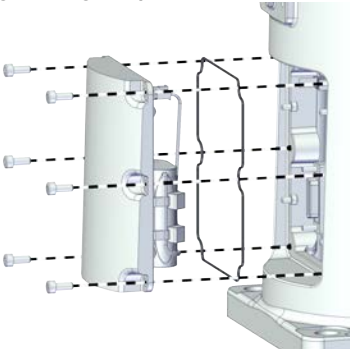
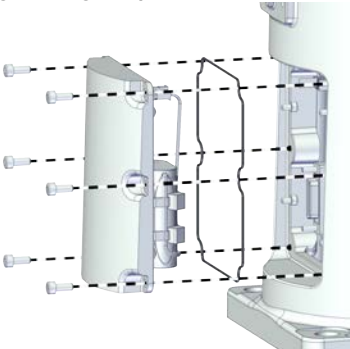
	Action	Note
3	<p>Refit the SMB cover assembly.</p> <p> Note</p> <p>For robots with protection class IP54 (option 3350-540)</p> <p>For robots with protection type Clean Room (option 3351-1)</p> <p>Check the gasket for the SMB cover.</p> <p> Tip</p> <p>Replace the gasket if needed.</p>	<p>For robots with protection class IP30 (option 3350-300)</p> <p>Screws: Hex socket head cap screw M4x10 12.9 Lafre 2C2B/FC6.9 (6 pcs)</p> <p>Tightening torque: 2.6 Nm</p> 
4	<p>Secure the SMB cover to the base with the screws.</p>	<p>xx210000944</p> <p>For robots with protection type Clean Room (option 3351-1)</p> <p>Screws: Stainless Screw Hexagon Socket Head Cap, Clean Room 3HAC075438-001 (6 pcs)</p> <p>Tightening torque: 2.6 Nm</p>  <p>xx2100002433</p> <p>For robots with protection class IP54 (option 3350-540)</p> <p>Screws: Hex socket head cap screw M4x10 12.9 Lafre 2C2B/FC6.9 (6 pcs)</p> <p>Tightening torque: 2.6 Nm</p>  <p>xx2100002433</p>

Continues on next page

5 Repair

5.4.2 Replacing the axis-1 timing belt

Continued

Refitting the main harness

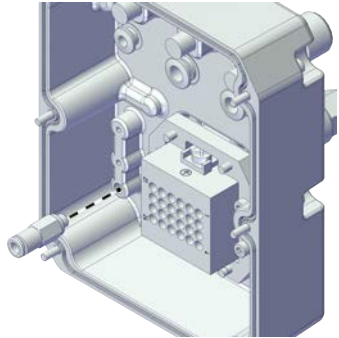
	Action	Note
1	<p>For robots with protection type Clean Room: Clean the joints that have been opened and wipe the parts free from particles with spirit on a lint free. See Cut the paint or surface on the robot before replacing parts on page 118</p> <p> Note</p> <p>After all repair work, wipe the Clean Room robot free from particles with spirit on a lint free cloth.</p>	
2	<p>For robots with protection type Clean Room (option 3351-1) Refit the one way valve by screwing it into the main harness assembly.</p>	 xx2200000281

Continues on next page

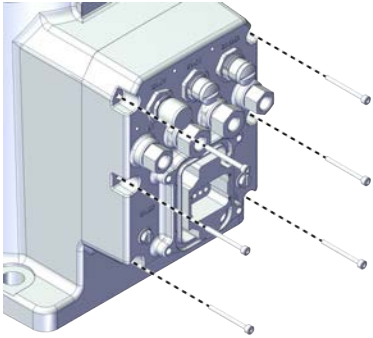
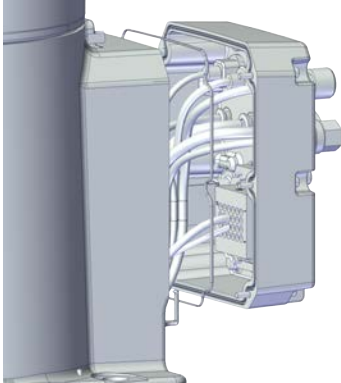
	Action	Note
3	For rear outlet cable version, refit the main harness to the base.	For rear outlet cable version:
4	Secure with the screws.	<p>For robots with protection class IP30 (option 3350-300)</p> <p>Screws: Hex socket head cap screw M3x30 12.9 Lafre 2C2B/FC6.9 (6 pcs)</p> <p>Tightening torque: 1.2 Nm ±10%</p>  <p>xx210000953</p> <p>For robots with protection class IP54 (option 3350-540)</p> <p>For robots with protection type Clean Room (option 3351-1)</p> <p>Screws: Hex socket head cap screw M3x30 12.9 Lafre 2C2B/FC6.9 (6 pcs)</p> <p>Tightening torque: 1.2 Nm ±10%</p>  <p>xx2100002436</p>

Continues on next page

5 Repair

5.4.2 Replacing the axis-1 timing belt

Continued

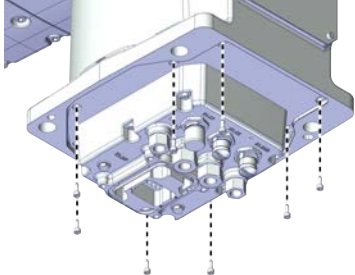
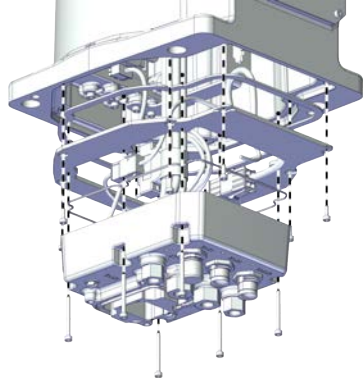
	Action	Note
5	<p>For underneath outlet cable version, refit the main harness assembly to the base.</p> <p> Note</p> <p>Refit the bottom plate to the main harness if needed.</p>	<p>For underneath outlet cable version:</p> <p>For robots with protection class IP30 (option 3350-300)</p> <p>Screws: Hex socket head cap screw M3x30 12.9 Lafre 2C2B/FC6.9 (8 pcs)</p> <p>Tightening torque: 1.2 Nm \pm10%</p>
6	Secure with the screws.	<p></p> <p>xx2100001204</p> <p>For robots with protection class IP54 (option 3350-540)</p> <p>For robots with protection type Clean Room (option 3351-1)</p> <p>Screws: Hex socket head cap screw M3x30 12.9 Lafre 2C2B/FC6.9 (8 pcs)</p> <p>Tightening torque: 1.2 Nm \pm10%</p> <p></p> <p>xx2100002437</p>

Refitting the base plate/ rear plate

	Action	Note
1	<p>For robots with protection type Clean Room:</p> <p>Clean the joints that have been opened and wipe the parts free from particles with spirit on a lint free. See Cut the paint or surface on the robot before replacing parts on page 118</p> <p> Note</p> <p>After all repair work, wipe the Clean Room robot free from particles with spirit on a lint free cloth.</p>	





Continues on next page

	Action	Note
2	Apply grease to the internal harness, cover all moving area of the harness.	

5 Repair

5.4.2 Replacing the axis-1 timing belt

Continued

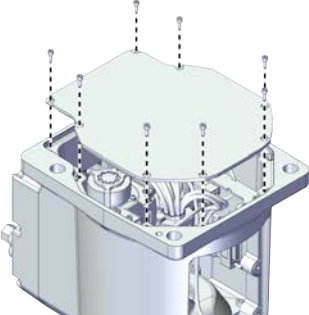
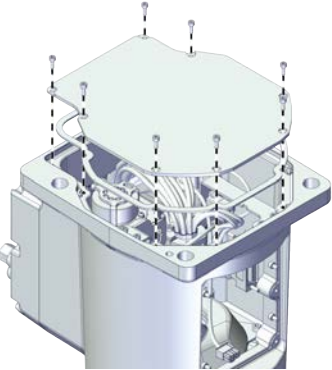
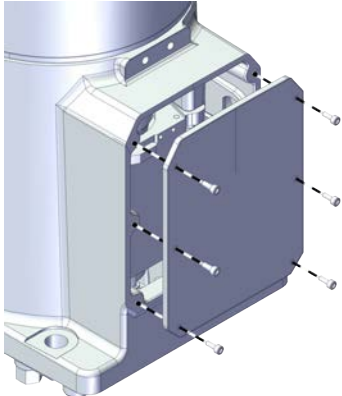
	Action	Note
3	<p>For rear outlet cable version, refit the base plate to the base.</p> <p> Note</p> <p>For robots with protection class IP54 (option 3350-540) For robots with protection type Clean Room (option 3351-1) Check the gasket for the base plate before refitting the base plate.</p> <p> Tip</p> <p>Replace the gasket if needed.</p> <p>For undeneath outlet cable version, refit the rear plate to the base.</p> <p> Note</p> <p>For robots with protection class IP54 (option 3350-540) For robots with protection type Clean Room (option 3351-1) Check the gasket for the rear plate before refitting the rear plate.</p> <p> Tip</p> <p>Replace the gasket if needed.</p>	<p>Screws: Hex socket head cap screw M3x30 12.9 Lafre 2C2B/FC6.9 (6 pcs) Tightening torque: 1.2 Nm ±10%</p> <p>For rear outlet cable version: For robots with protection class IP30 (option 3350-300)</p>  <p>xx2100000946</p> <p>For robots with protection class IP54 (option 3350-540) For robots with protection type Clean Room (option 3351-1)</p>  <p>xx2100002434</p> <p>For undeneath outlet cable version: For robots with protection class IP30 (option 3350-300)</p>  <p>xx2100001202</p>
4	<p>Secure the base plate/ rear plate to the base with the screws.</p>	

Continues on next page

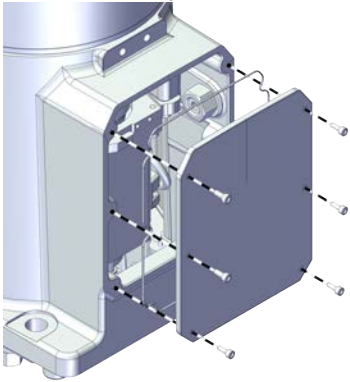
	Action	Note
		<p>For robots with protection class IP54 (option 3350-540)</p> <p>For robots with protection type Clean Room (option 3351-1)</p>  <p>xx2100002435</p>
5	Refit the robot back to the ground.	
6	Secure with the screws.	<p>Screws: Hex socket head cap screw M12x35 12.9 Gleitmo 603+Geomet 500 (4 pcs)</p> <p>Steel</p> <p>Washers: 24 mm x 13 mm x 2.5 mm (4 pcs)</p> <p>Tightening torque: 56 Nm \pm10%</p>

Refitting the cable ferrule and bracket in the outer arm







	Action	Note
1	<p>For robots with protection type Clean Room: Clean the joints that have been opened and wipe the parts free from particles with spirit on a lint free. See Cut the paint or surface on the robot before replacing parts on page 118</p> <p> Note</p> <p>After all repair work, wipe the Clean Room robot free from particles with spirit on a lint free cloth.</p>	
2	Lay the internal harness in a natural state without distortion.	

Continues on next page

5 Repair

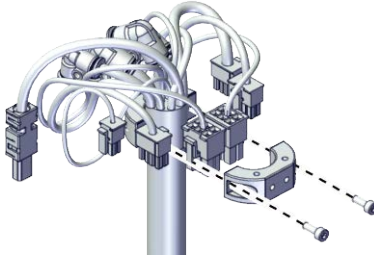

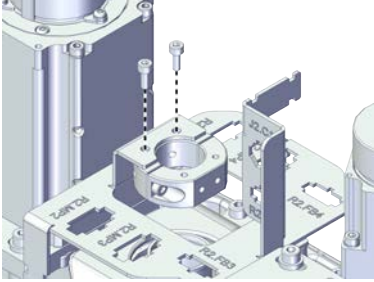



5.4.2 Replacing the axis-1 timing belt

Continued

	Action	Note
3	<p>Refit the cable ferrule and secure it with the screws.</p> <p> Tip</p> <p>The air hoses should face the process hub side.</p> <p> Tip</p> <p>The position with wrapped tape is the marked position for the cable ferrule.</p> <p> Tip</p> <p>Align all the cable ferrules so that the cable is in a natural bending position to avoid twisting.</p>	<p>Screws: Hex socket head cap screw M3x8 12.9 Lafre 2C2B/FC6.9 (2 pcs)</p> <p>Tightening torque: 1.2 Nm ±10%</p>  <p>xx1800002849</p>
4	<p>Secure the cable ferrule to the bracket.</p> <p> Tip</p> <p>Align all the cable ferrules so that the cable is in a natural bending position to avoid twisting.</p> <p> Note</p> <p>The harness are not visible due to the cleanness requirements of the illustration. They are still existing inside the cable ferrule in the actual situation.</p>	<p>Screws: Hex socket head cap screw M3x8 12.9 Lafre 2C2B/FC6.9 (2 pcs)</p> <p>Tightening torque: 1.2 Nm ±10%</p>  <p>xx2100000940</p>
5	<p>Refit the bracket without securing.</p> <p> Tip</p> <p>Do not secure it with the screws before the cable ferrule installed well.</p> <p> Note</p> <p>The harness are not visible due to the cleanness requirements of the illustration. They are still existing inside the cable ferrule in the actual situation.</p>	

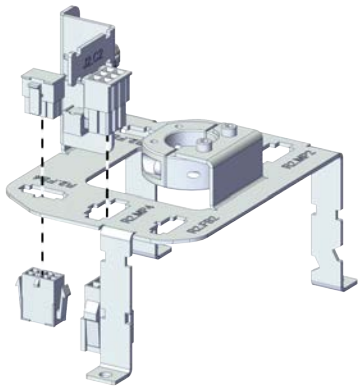
Continues on next page

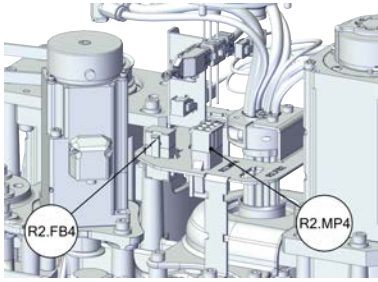
Reconnecting the connectors for axis-4 motor

	Action	Note
1	<p>For robots with protection type Clean Room: Clean the joints that have been opened and wipe the parts free from particles with spirit on a lint free. See Cut the paint or surface on the robot before replacing parts on page 118</p> <p> Note</p> <p>After all repair work, wipe the Clean Room robot free from particles with spirit on a lint free cloth.</p>	
	<p>Insert the female head of the connectors to the bracket accordingly.</p> <p> Tip</p> <p>The mistake proofing measure has been applied to the connectors, the connectors may be damaged if excessive force is used.</p> <p> Note</p> <p>The harness are not visible due to the cleanness requirements of the illustration. They are still existing inside the cable ferrule in the actual situation.</p>	 <p>xx210000939</p>
2	<p>Reconnect the connectors.</p> <ul style="list-style-type: none"> • R2.MP4 • R2.FB4 <p> Tip</p> <p>See the number markings on the connectors for help to find the corresponding connector.</p>	 <p>xx210000938</p>
3	<p>Route the cabling on the axis-4 motor.</p> <p> CAUTION</p> <p>Correct cable routing is highly important. If the cables are routed and secured incorrectly the cables can be damaged.</p>	







Continues on next page

5 Repair

5.4.2 Replacing the axis-1 timing belt

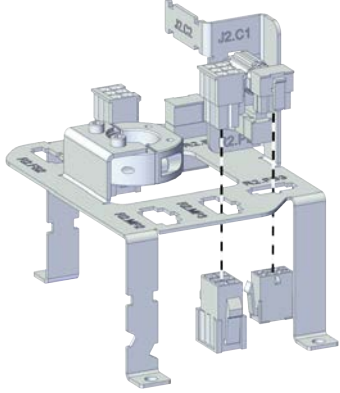

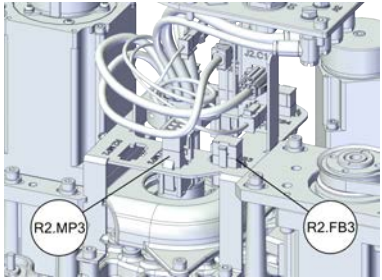



Continued

Reconnecting the connectors for axis-3 motor

	Action	Note
1	<p>For robots with protection type Clean Room: Clean the joints that have been opened and wipe the parts free from particles with spirit on a lint free. See Cut the paint or surface on the robot before replacing parts on page 118</p> <p> Note</p> <p>After all repair work, wipe the Clean Room robot free from particles with spirit on a lint free cloth.</p>	
2	<p>Insert the female head of the connectors to the bracket accordingly.</p> <p> Tip</p> <p>The mistake proofing measure has been applied to the connectors, the connectors may be damaged if excessive force is used.</p> <p> Note</p> <p>The harness are not visible due to the cleanness requirements of the illustration. They are still existing inside the cable ferrule in the actual situation.</p>	 <p>xx2100000937</p>
3	<p>Reconnect the connectors.</p> <ul style="list-style-type: none"> • R2.MP3 • R2.FB3 <p> Tip</p> <p>See the number markings on the connectors for help to find the corresponding connector.</p>	 <p>xx2100000936</p>
4	<p>Route the cabling on the axis-3 motor.</p> <p> CAUTION</p> <p>Correct cable routing is highly important. If the cables are routed and secured incorrectly the cables can be damaged.</p>	

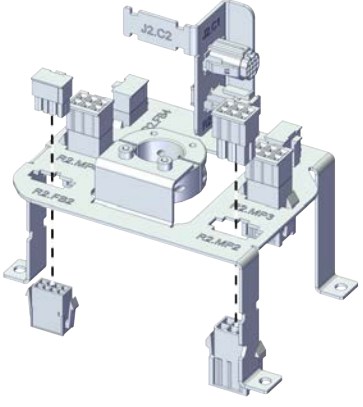
Continues on next page

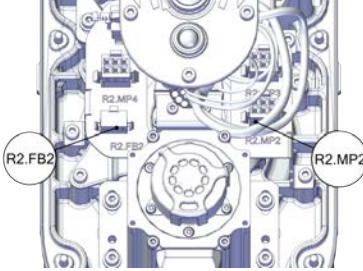
Reconnecting the connectors for axis-2 motor

	Action	Note
1	<p>For robots with protection type Clean Room: Clean the joints that have been opened and wipe the parts free from particles with spirit on a lint free. See Cut the paint or surface on the robot before replacing parts on page 118</p> <p> Note</p> <p>After all repair work, wipe the Clean Room robot free from particles with spirit on a lint free cloth.</p>	
2	<p>Insert the female head of the connectors to the bracket accordingly.</p> <p> Tip</p> <p>The mistake proofing measure has been applied to the connectors, the connectors may be damaged if excessive force is used.</p> <p> Note</p> <p>The harness are not visible due to the cleanness requirements of the illustration. They are still existing inside the cable ferrule in the actual situation.</p>	 <p>xx2100000935</p>
3	<p>Reconnect the connectors.</p> <ul style="list-style-type: none"> • R2.MP2 • R2.FB2 <p> Tip</p> <p>See the number markings on the connectors for help to find the corresponding connector.</p>	 <p>xx2100000934</p>
4	<p>Route the cabling behind the axis-2 motor.</p> <p> CAUTION</p> <p>Correct cable routing is highly important. If the cables are routed and secured incorrectly the cables can be damaged.</p>	







Continues on next page

5 Repair

5.4.2 Replacing the axis-1 timing belt

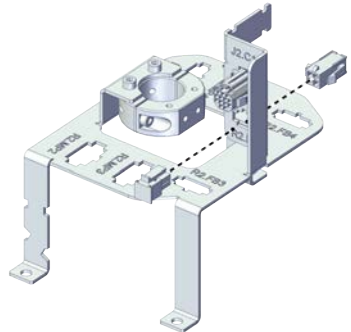

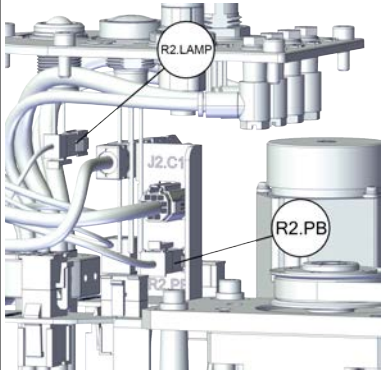
Continued

Reconnecting the connector for PB

	Action	Note
1	<p>For robots with protection type Clean Room: Clean the joints that have been opened and wipe the parts free from particles with spirit on a lint free. See Cut the paint or surface on the robot before replacing parts on page 118</p> <p> Note</p> <p>After all repair work, wipe the Clean Room robot free from particles with spirit on a lint free cloth.</p>	
2	<p>Insert the female head of the PB connector to the bracket accordingly.</p> <p> Tip</p> <p>The mistake proofing measure has been applied to the connectors, the connectors may be damaged if excessive force is used.</p> <p> Note</p> <p>The harness are not visible due to the cleanness requirements of the illustration. They are still existing inside the cable ferrule in the actual situation.</p>	 <p>xx2100001031</p>
3	<p>Reconnect the connector.</p> <ul style="list-style-type: none"> • R2.PB • R2.LAMP <p> Tip</p> <p>See the number markings on the connectors for help to find the corresponding connector.</p>	 <p>xx2100001030</p>
4	<p>Route and secure the cabling with cable straps if needed.</p> <p> CAUTION</p> <p>Correct cable routing is highly important. If the cables are routed incorrectly the cables can be damaged.</p>	

Continues on next page

Reconnecting the air hoses, CP/CS cabling and Ethernet cabling (if equipped)







	Action	Note
1	<p>For robots with protection type Clean Room: Clean the joints that have been opened and wipe the parts free from particles with spirit on a lint free. See Cut the paint or surface on the robot before replacing parts on page 118</p> <p> Note</p> <p>After all repair work, wipe the Clean Room robot free from particles with spirit on a lint free cloth.</p>	
2	<p>Route the air hoses on the process hub behind the bracket.</p> <p> CAUTION</p> <p>Correct cable routing is highly important. If the cables are routed and secured incorrectly the cables can be damaged.</p>	

Continues on next page

5 Repair

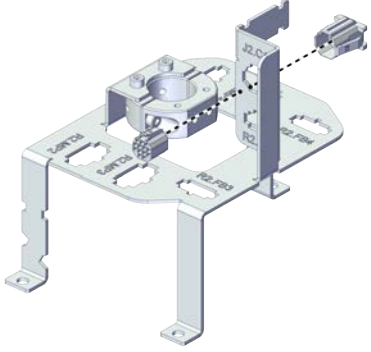
5.4.2 Replacing the axis-1 timing belt

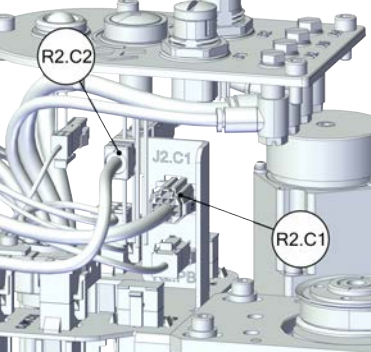

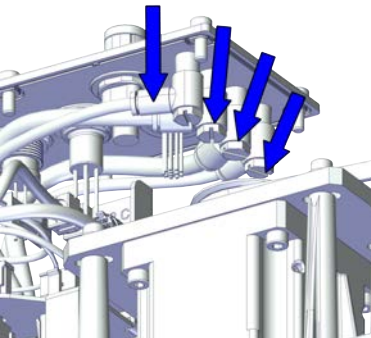
Continued

	Action	Note
3	<p>Insert the female head of the C1 cabling connector to the bracket accordingly.</p> <p> Tip</p> <p>The mistake proofing measure has been applied to the connectors, the connectors may be damaged if excessive force is used.</p> <p> Note</p> <p>The harness are not visible due to the cleanness requirements of the illustration. They are still existing inside the cable ferrule in the actual situation.</p>	 <p>xx2100001034</p>
4	<p>For robots with C1 cabling</p> <p>Reconnect the connector.</p> <ul style="list-style-type: none"> • R2.C1 <p> Tip</p> <p>See the number markings on the air hoses for help to find the corresponding air hoses.</p> <p>The air hoses with the same number connect to the same L-shaped connector.</p>	 <p>xx2100001033</p>
5	<p>For robots with C2 cabling</p> <p>Reconnect the connector.</p> <ul style="list-style-type: none"> • R1.C2 <p> Tip</p> <p>See the number markings on the air hoses for help to find the corresponding air hoses.</p> <p>The air hoses with the same number connect to the same L-shaped connector.</p>	
6	<p>Secure the C2 cabling to the C2 bracket with the cable straps.</p>	
7	<p>Reconnect the air hoses in a cross pattern with the L-shaped connectors.</p> <p> Tip</p> <p>See the number markings on the air hoses for help to find the corresponding air hoses.</p> <p>The air hoses with the same number connect to the same Y-shaped connector.</p>	 <p>xx2100001032</p>

Continues on next page

	Action	Note
8	<p>Route and secure the cabling with cable straps if needed.</p> <p> CAUTION</p> <p>Correct cable routing is highly important. If the cables are routed and secured incorrectly the cables can be damaged.</p>	

Securing the bracket in the outer arm

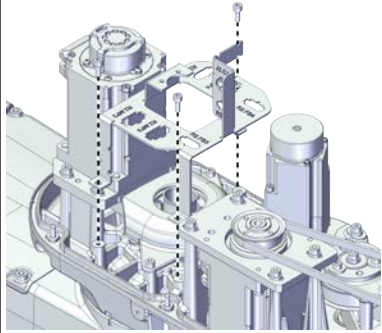
	Action	Note
1	<p>For robots with protection type Clean Room: Clean the joints that have been opened and wipe the parts free from particles with spirit on a lint free. See Cut the paint or surface on the robot before replacing parts on page 118</p> <p> Note</p> <p>After all repair work, wipe the Clean Room robot free from particles with spirit on a lint free cloth.</p>	
2	<p>Refit the bracket.</p> <p> Tip</p> <p>Do not secure it with the screws before the cable ferrule installed well.</p> <p> Note</p> <p>The harness are not visible due to the cleanness requirements of the illustration. They are still existing inside the cable ferrule in the actual situation.</p>	<p>Screws: Hex socket head cap screw M4x10 12.9 Lafre 2C2B/FC6.9 (3 pcs)</p> <p>Tightening torque: 1.2 Nm ±10%</p>  <p>xx2100000941</p>

Refitting the cover of the outer arm



	Action	Note
1	<p>For robots with protection type Clean Room: Clean the joints that have been opened and wipe the parts free from particles with spirit on a lint free. See Cut the paint or surface on the robot before replacing parts on page 118</p> <p> Note</p> <p>After all repair work, wipe the Clean Room robot free from particles with spirit on a lint free cloth.</p>	

Continues on next page

5 Repair

5.4.2 Replacing the axis-1 timing belt

Continued

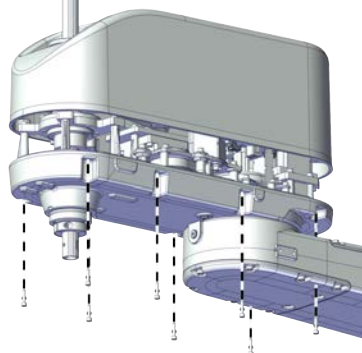
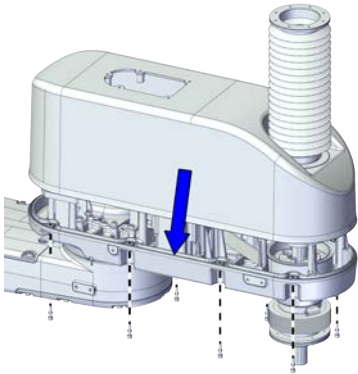

	Action	Note
2	<p>Refit the cover.</p> <p> Note</p> <p>For robots with protection class IP54 (option 3350-540)</p> <p>For robots with protection type Clean Room (option 3351-1)</p> <p>Refit the cover with bellow.</p> <p>Check the gasket for the outer arm cover.</p> <p> Tip</p> <p>Replace the gasket if needed.</p> <p> CAUTION</p> <p>The gasket is in the outer arm.</p>	<p>Screw: Hex socket head cap screw M4x16 12.9 Lafre 2C2B/FC6.9 (8 pcs)</p> <p>Tightening torque: 2 Nm ±10%</p> <p>For robots with protection class IP30 (option 3350-300)</p>  <p>xx210000933</p>
3	<p>Refit the screws.</p>	<p>For robots with protection class IP54 (option 3350-540)</p> <p>For robots with protection type Clean Room (option 3351-1)</p>  <p>xx2100002427</p>

For Clean Room/ IP54 robots

Refitting the top cover and the flange with bearing

	Action	Note
1	<p>For robots with protection type Clean Room:</p> <p>Clean the joints that have been opened and wipe the parts free from particles with spirit on a lint free. See Cut the paint or surface on the robot before replacing parts on page 118</p> <p> Note</p> <p>After all repair work, wipe the Clean Room robot free from particles with spirit on a lint free cloth.</p>	

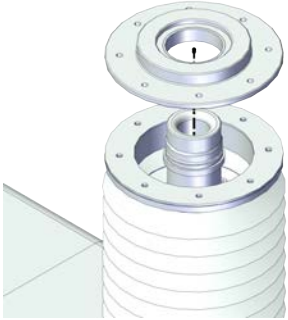
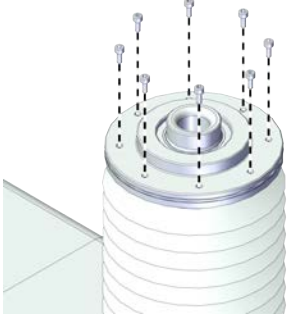
Continues on next page

	Action	Note
2	<p>For robots with protection class IP54 (option 3350-540) For robots with protection type Clean Room (option 3351-1) Install the flange with bearing to the extension shaft.</p>	 <p>xx2100002402</p>
3	<p>For robots with protection class IP54 (option 3350-540) For robots with protection type Clean Room (option 3351-1) Refit the screws to the flange with bearing.</p>	<p>Screws: Hex socket head cap screw M2.5x6 12.9 Lafre 2C2B/FC6.9 (8 pcs) Tightening torque: 0.8 Nm ±10%</p>  <p>xx2100002401</p>
4	<p>For robots with protection class IP54 (option 3350-540) For robots with protection type Clean Room (option 3351-1) Refit the top cover to the ball screw.</p> <p> Tip</p> <p>The top surface of the cover should be flush with the top end of the ball screw.</p>	 <p>xx2100002399</p>

Continues on next page

5 Repair

5.4.2 Replacing the axis-1 timing belt

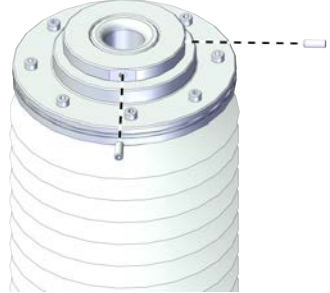

Continued

	Action	Note
5	<p>For robots with protection class IP54 (option 3350-540)</p> <p>For robots with protection type Clean Room (option 3351-1)</p> <p>Refit the locking screws.</p>	<p>Screws: Hexagon socket set screws with flat point, ISO 4026 stainless steel M3x8 (2 pcs)</p> <p>Tightening torque: 0.4 Nm \pm10%</p>  <p>xx2100002398</p>

Securing the process hub to outer arm cover

	Action	Note
1	<p>For robots with protection type Clean Room:</p> <p>Clean the joints that have been opened and wipe the parts free from particles with spirit on a lint free. See Cut the paint or surface on the robot before replacing parts on page 118</p> <p> Note</p> <p>After all repair work, wipe the Clean Room robot free from particles with spirit on a lint free cloth.</p>	
2	Insert the process hub from the outer arm cover.	

Continues on next page

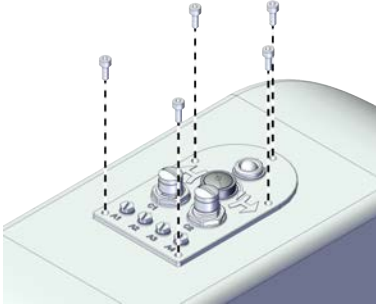
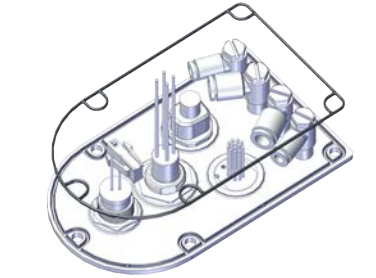
	Action	Note
3	<p>Secure the process hub to the outer arm cover with the screws.</p> <p> Note</p> <p>For robots with protection class IP54 (option 3350-540)</p> <p>For robots with protection type Clean Room (option 3351-1)</p> <p>Check the gasket for the process hub.</p> <p> Tip</p> <p>Replace the gasket if needed.</p> <p> CAUTION</p> <p>Be aware of the cabling that is attached to the cover! The cover can not be removed completely until the connectors are disconnected, as shown in following steps.</p>	<p>Screws: Hex socket head cap screw M4x10 12.9 Lafre 2C2B/FC6.9 (5 pcs)</p> <p>Tightening torque: 2.6 Nm±10%</p> <p>For robots with protection class IP30 (option 3350-300)</p>  <p>xx2100000932</p> <p>For robots with protection class IP54 (option 3350-540)</p> <p>For robots with protection type Clean Room (option 3351-1)</p>  <p>xx2100002438</p>

Refitting the axis-1 cover



	Action	Note
1	<p>For robots with protection type Clean Room:</p> <p>Clean the joints that have been opened and wipe the parts free from particles with spirit on a lint free. See Cut the paint or surface on the robot before replacing parts on page 118</p> <p> Note</p> <p>After all repair work, wipe the Clean Room robot free from particles with spirit on a lint free cloth.</p>	

Continues on next page

5 Repair

5.4.2 Replacing the axis-1 timing belt

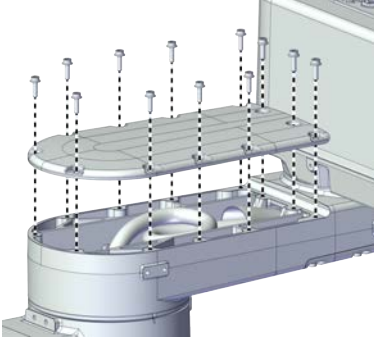
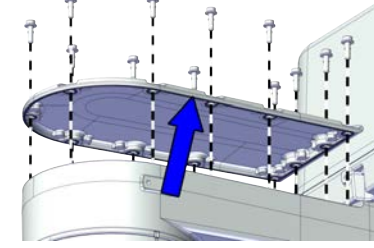

Continued

	Action	Note
2	<p>Refit the cover.</p> <p> Note</p> <p>For robots with protection class IP54 (option 3350-540)</p> <p>For robots with protection type Clean Room (option 3351-1)</p> <p>Check the gasket for the cover before refitting the cover.</p> <p> Tip</p> <p>Replace the gasket if needed.</p>	<p>For IRB 920T-6/0.45 : Screw: Hex socket head cap flange screw M5x16 12.9 Lafre 2C2B/FC6.9+PrO-COat111 (10 pcs)</p> <p>For IRB 920T-6/0.55 : Screw: Hex socket head cap flange screw M5x16 12.9 Lafre 2C2B/FC6.9+PrO-COat111 (12 pcs)</p> <p>For IRB 920T-6/0.65 : Screw: Hex socket head cap flange screw M5x16 12.9 Lafre 2C2B/FC6.9+PrO-COat111 (16 pcs)</p> <p>Tightening torque: 5.4 Nm ±3%</p> <p>For robots with protection class IP30 (option 3350-300)</p>
3	<p>Refit the screws.</p>	 <p>xx2100000942</p> <p>For robots with protection class IP54 (option 3350-540)</p> <p>For robots with protection type Clean Room (option 3351-1)</p>  <p>xx2100002428</p>

Refitting the axis-2 cover

	Action	Note
1	<p> DANGER</p> <p>Make sure that all supplies for electrical power, hydraulic pressure, and air pressure are turned off.</p>	

Continues on next page

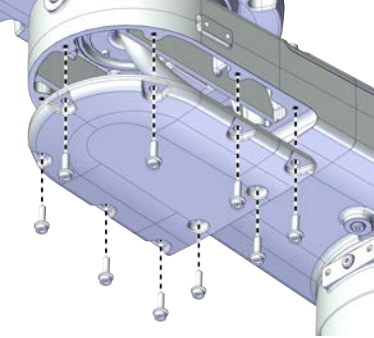
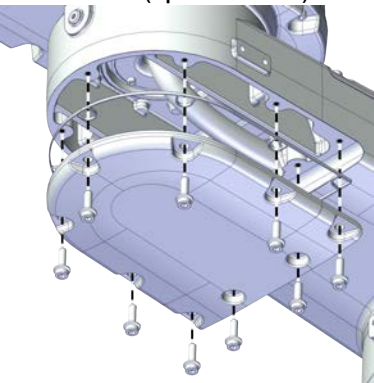
	Action	Note
2	<p> CAUTION</p> <p>For robots with protection type Clean Room Always cut the paint with a knife and grind the paint edge when disassembling parts of the robot! See <i>Cut the paint or surface on the robot before replacing parts on page 118.</i></p>	
3	<p>Refit the cover.</p> <p> Note</p> <p>For robots with protection class IP54 (option 3350-540) For robots with protection type Clean Room (option 3351-1) Check the gasket for the cover before refitting the cover.</p> <p> Tip</p> <p>Replace the gasket if needed.</p>	<p>Screws: Hex socket head cap flange screw M5x16 12.9 Lafre 2C2B/FC6.9+PrO-COat111 (9 pcs) Tightening torque: 1.2 Nm ±10%</p> <p>For robots with protection class IP30 (option 3350-300)</p>  <p>xx210000943</p>
4	<p>Refit the screws.</p>	<p>For robots with protection class IP54 (option 3350-540) For robots with protection type Clean Room (option 3351-1)</p>  <p>xx2100002451</p>



Continues on next page

5 Repair

5.4.2 Replacing the axis-1 timing belt

Continued

Concluding procedure

	Action	Note
1	<p>For robots with protection type Clean Room: Seal and paint the joints that have been opened. See Cut the paint or surface on the robot before replacing parts on page 118</p> <p> Note</p> <p>After all repair work, wipe the Clean Room robot free from particles with spirit on a lint free cloth.</p>	
2	Recalibrate the robot.	Calibration is detailed in section Calibration on page 945 .
3	<p> DANGER</p> <p>Make sure all safety requirements are met when performing the first test run.</p>	

5.5 Inner arm

5.5.1 Replacing the inner arm

Location of the inner arm

The inner arm is located as shown in the figure.

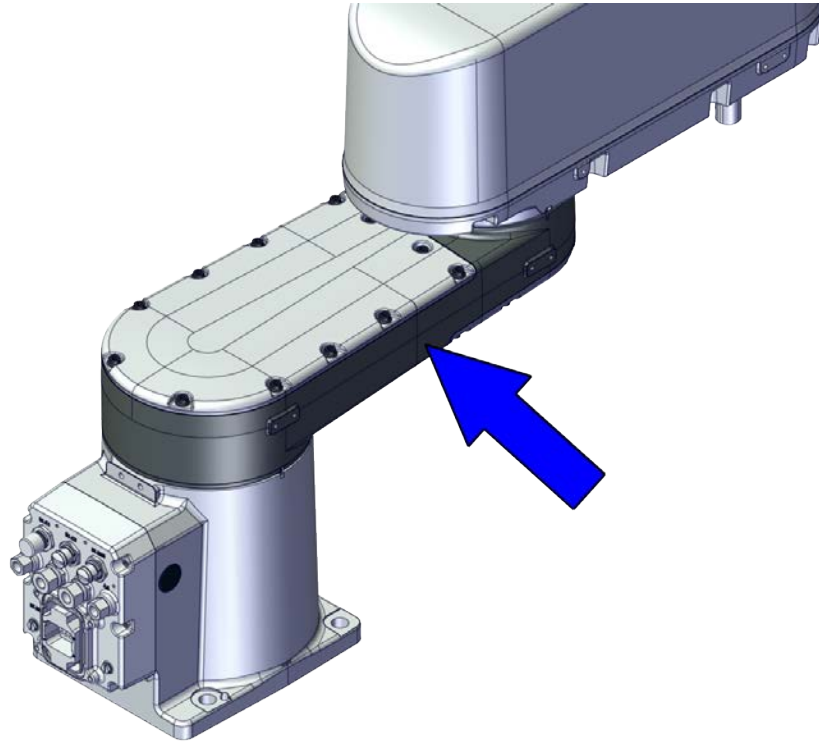

xx2100001012

Required spare parts



Note

The spare part numbers that are listed in the table can be out of date. See the latest spare parts of the IRB 920 via myABB Business Portal, www.abb.com/myABB.

Spare part	Article number	Note
Inner arm, 450 mm	3HAC076570-001	Used for IRB 920T-6/0.45
Inner arm, 550 mm	3HAC076571-001	Used for IRB 920T-6/0.55
Inner arm, 650 mm	3HAC076572-001	Used for IRB 920T-6/0.65
Axis 1 Cover, 450 mm	3HAC076607-001	
Axis 1 Cover, 550 mm	3HAC076608-001	
Axis 1 Cover, 650 mm	3HAC076609-001	
Axis 2 Cover	3HAC076610-001	

Continues on next page

5 Repair

5.5.1 Replacing the inner arm

Continued

Spare part	Article number	Note
Inner arm, 450 mm	3HAC081475-001	
Inner arm, 550 mm	3HAC081476-001	
Inner arm, 550 mm	3HAC081477-001	
Axis 1 Cover, 450 mm	3HAC081490-001	
Axis 1 Cover, 550 mm	3HAC081491-001	
Axis 1 Cover, 650 mm	3HAC081492-001	
Axis 2 Cover	3HAC081493-001	
Gasket, upper cover, 450 mm	3HAC073606-001	
Gasket, upper cover, 550 mm	3HAC073605-001	Used with protection type Clean Room.
Gasket, upper cover, 650 mm	3HAC073604-001	
Gasket, low cover	3HAC073607-001	

Required tools and equipment

Equipment	Article number	Note
Standard toolkit	-	Content is defined in section Standard toolkit on page 996 .
Calibration toolbox, Axis Calibration	3HAC055412-001	Delivered as a set of calibration tools. Required if Axis Calibration is the valid calibration method for the robot.
Sonic tension meter	-	Used for measuring the timing belt tension.
Handheld dynamometer	-	Used for measuring the timing belt tension.

Required consumables

Consumable	Article number	Note
Cable straps	-	
Grease	3HAC029132-001	FM 222

Continues on next page

Deciding calibration routine

Decide which calibration routine to be used, based on the information in the table. Depending on which routine is chosen, action might be required prior to beginning the repair work of the robot, see the table.

	Action	Note
1	Decide which calibration routine to use for calibrating the robot. <ul style="list-style-type: none"> Reference calibration. External cable packages (DressPack) and tools can stay fitted on the robot. Fine calibration. All external cable packages (DressPack) and tools must be removed from the robot. 	
	If the robot is to be calibrated with reference calibration: Find previous reference values for the axis or create new reference values. These values are to be used after the repair procedure is completed, for calibration of the robot. If no previous reference values exist, and no new reference values can be created, then reference calibration is not possible.	Follow the instructions given in the reference calibration routine on the FlexPendant to create reference values. Creating new values requires possibility to move the robot. Read more about reference calibration for Axis Calibration in Reference calibration routine on page 957 .
	If the robot is to be calibrated with fine calibration: Remove all external cable packages (DressPack) and tools from the robot.	

Removing the inner arm

Use these procedures to remove the inner arm.

Preparations before removing the inner arm



	Action	Note
1	Decide which calibration routine to use, and take actions accordingly prior to beginning the repair procedure.	
2	If there is no enough space for the maintenance work, remove the robot from the wall and place it on the maintenance bracket.  CAUTION Do not lay down the robot during the transportation, always keep it straight. If the robot lay down in any situation, the grease may come out from gearbox.	

Continues on next page

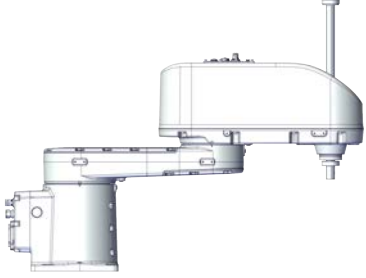

5 Repair

5.5.1 Replacing the inner arm



Continued

	Action	Note
3	Jog all axes to zero position.	 xx2100000930
4	 DANGER Turn off all: <ul style="list-style-type: none"> • electric power supply • hydraulic pressure supply • air pressure supply to the robot, before entering the safeguarded space.	
5	 CAUTION For robots with protection type Clean Room Always cut the paint with a knife and grind the paint edge when disassembling parts of the robot! See Cut the paint or surface on the robot before replacing parts on page 118 .	

Removing the process hub screws

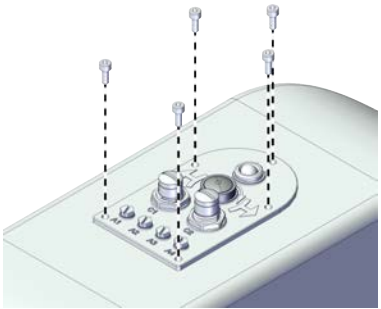
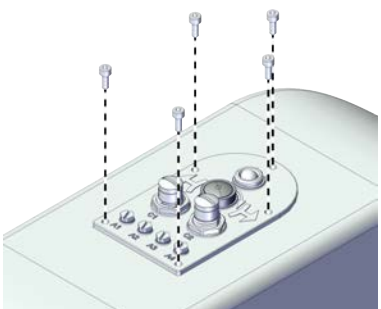

	Action	Note
1	 DANGER Make sure that all supplies for electrical power, hydraulic pressure, and air pressure are turned off.	
2	 CAUTION For robots with protection type Clean Room Always cut the paint with a knife and grind the paint edge when disassembling parts of the robot! See Cut the paint or surface on the robot before replacing parts on page 118 .	

Continues on next page

	Action	Note
3	<p>Remove the screws on the process hub.</p> <p> Note</p> <p>For robots with protection class IP54 (option 3350-540)</p> <p>For robots with protection type Clean Room (option 3351-1)</p> <p>Remove the screws on the process hub and take out the gasket.</p> <p> Tip</p> <p>Check the gasket and replace it if needed.</p>	<p>For robots with protection class IP30</p>  <p>xx2100000932</p> <p>For robots with protection class IP54 (option 3350-540)</p> <p>For robots with protection type Clean Room (option 3351-1)</p>  <p>xx2100000932</p>
4	Insert the process hub to the outer arm.	

For Clean Room/ IP54 robots

Removing the top cover and the flange with bearing



	Action	Note
1	<p> DANGER</p> <p>Make sure that all supplies for electrical power, hydraulic pressure, and air pressure are turned off.</p>	
2	<p> CAUTION</p> <p>For robots with protection type Clean Room</p> <p>Always cut the paint with a knife and grind the paint edge when disassembling parts of the robot!</p> <p>See Cut the paint or surface on the robot before replacing parts on page 118.</p>	

Continues on next page

5 Repair



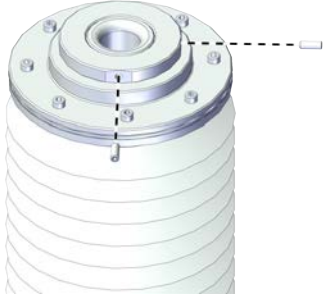

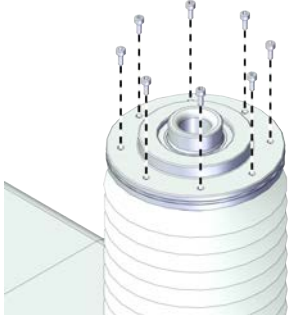
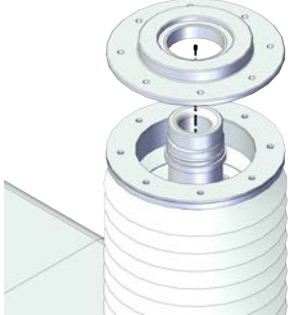
5.5.1 Replacing the inner arm

Continued

	Action	Note
3	<p>For robots with protection class IP54 (option 3350-540) For robots with protection type Clean Room (option 3351-1) Loose the locking screws.</p>	 <p>xx2100002398</p>
4	<p>For robots with protection class IP54 (option 3350-540) For robots with protection type Clean Room (option 3351-1) Remove the top cover from the ball screw.</p>	 <p>xx2100002399</p>
5	<p>For robots with protection class IP54 (option 3350-540) For robots with protection type Clean Room (option 3351-1) Remove the screws on the flange with bearing.</p>	 <p>xx2100002401</p>
6	<p>For robots with protection class IP54 (option 3350-540) For robots with protection type Clean Room (option 3351-1) Remove the flange with bearing.</p>	 <p>xx2100002402</p>

Continues on next page

Removing the cover of the outer arm

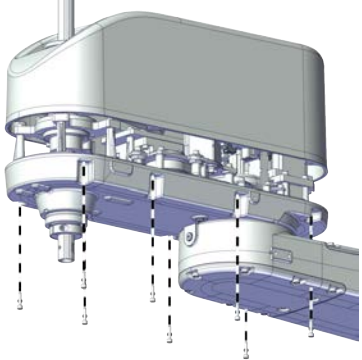
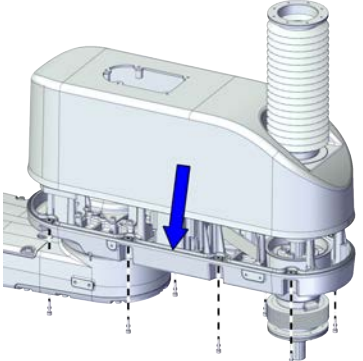
	Action	Note
1	 <p>DANGER</p> <p>Make sure that all supplies for electrical power, hydraulic pressure, and air pressure are turned off.</p>	
2	 <p>CAUTION</p> <p>For robots with protection type Clean Room Always cut the paint with a knife and grind the paint edge when disassembling parts of the robot! See Cut the paint or surface on the robot before replacing parts on page 118.</p>	
3	<p>Remove the screws on the cover of the outer arm and remove the cover.</p> <p> Note</p> <p>For robots with protection class IP54 (option 3350-540) For robots with protection type Clean Room (option 3351-1) Remove the cover with bellow and housing.</p> <p> Note</p> <p>The bellow does not need to be removed separately.</p> <p> Tip</p> <p>Check the gasket and replace it if needed.</p>	<p>For robots with protection class IP30</p>  <p>xx210000933</p> <p>For robots with protection class IP54 (option 3350-540) For robots with protection type Clean Room (option 3351-1)</p>  <p>xx2100002427</p>



Continues on next page

5 Repair





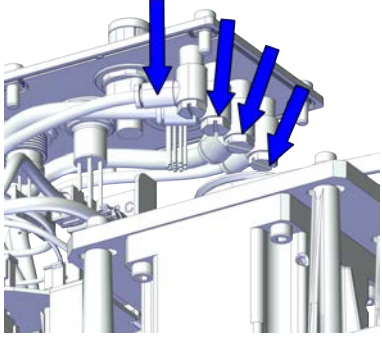

5.5.1 Replacing the inner arm

Continued

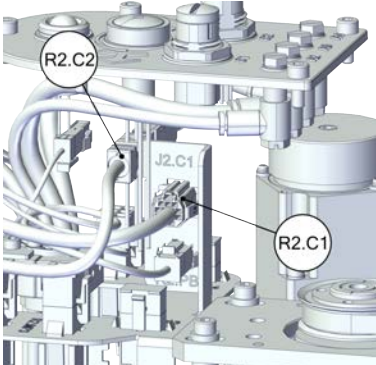
Disconnecting the air hoses, C1 cabling and C2 cabling (if equipped)

	Action	Note
1	 DANGER Make sure that all supplies for electrical power, hydraulic pressure, and air pressure are turned off.	
2	 CAUTION For robots with protection type Clean Room Always cut the paint with a knife and grind the paint edge when disassembling parts of the robot! See <i>Cut the paint or surface on the robot before replacing parts on page 118.</i>	
3	Disconnect the air hoses from the L-shaped connectors.	 xx2100001032

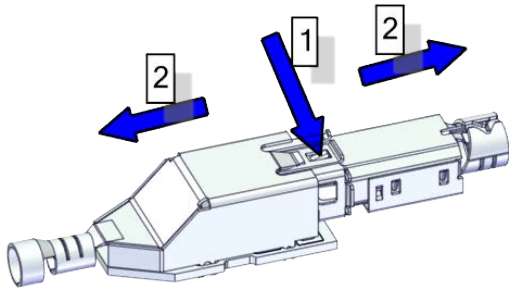
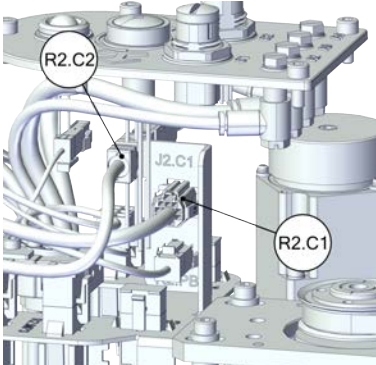
Continues on next page

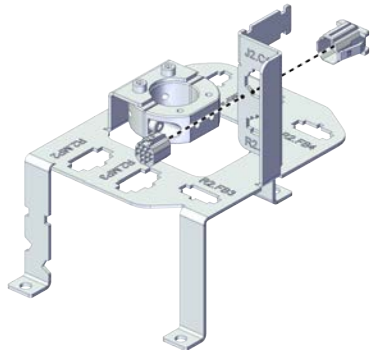



	Action	Note
4	<p>For robots with C1 cabling Disconnect the connector.</p> <ul style="list-style-type: none"> • R2.C1 	
5	<p>For robots with C2 cabling Disconnect the connector.</p> <ul style="list-style-type: none"> • R1.C2 <p> Tip</p> <p>Cut the cable straps for the R1.C2 at the same time.</p> <p> Tip</p> <p>Take photos of the connector and cable position before disconnecting them, to have as a reference when reconnecting.</p> <p> Tip</p> <p>The connector clip has to be pressed (1) and pushed forward (2) to separate the R1.C2 (for C2 cabling).</p> 	 <p>xx2100001033</p>
6	<p>Snap loose and remove the female head of the connectors from the bracket.</p> <p> Note</p> <p>The harness are not visible due to the cleanliness requirements of the illustration. They are still existing inside the cable ferrule in the actual situation.</p>	 <p>xx2100001034</p>

5 Repair

5.5.1 Replacing the inner arm

Continued

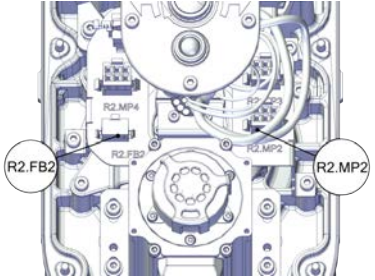

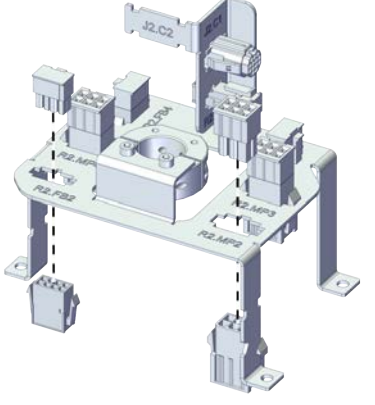
Disconnecting the connectors for axis-2 motor

	Action	Note
1	 DANGER Make sure that all supplies for electrical power, hydraulic pressure, and air pressure are turned off.	
2	 CAUTION For robots with protection type Clean Room Always cut the paint with a knife and grind the paint edge when disassembling parts of the robot! See Cut the paint or surface on the robot before replacing parts on page 118 .	
3	Disconnect the connectors. <ul style="list-style-type: none"> • R2.MP2 • R2.FB2 	 xx2100000934
4	Snap loose and remove the female head of the connectors from the bracket.  Note The harness are not visible due to the cleanliness requirements of the illustration. They are still existing inside the cable ferrule in the actual situation.	 xx2100000935

Disconnecting the connectors for axis-3 motor

	Action	Note
1	 DANGER Make sure that all supplies for electrical power, hydraulic pressure, and air pressure are turned off.	

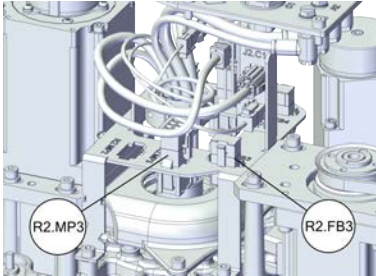
Continues on next page

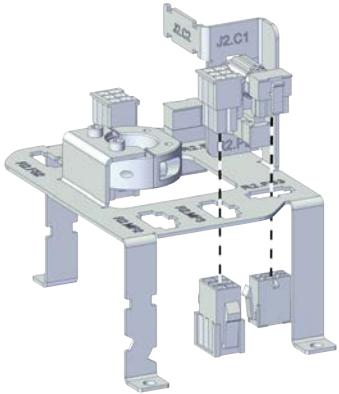
	Action	Note
2	<p> CAUTION</p> <p>For robots with protection type Clean Room Always cut the paint with a knife and grind the paint edge when disassembling parts of the robot! See Cut the paint or surface on the robot before replacing parts on page 118.</p>	
3	<p>Disconnect the connectors.</p> <ul style="list-style-type: none"> • R2.MP3 • R2.FB3 	 <p>xx2100000936</p>
4	<p>Snap loose and remove the female head of the connectors from the bracket.</p> <p> Note</p> <p>The harness are not visible due to the cleanness requirements of the illustration. They are still existing inside the cable ferrule in the actual situation.</p>	 <p>xx2100000937</p>



Disconnecting the connectors for axis-4 motor

	Action	Note
1	<p>For robots with protection type Clean Room: Clean the joints that have been opened and wipe the parts free from particles with spirit on a lint free. See Cut the paint or surface on the robot before replacing parts on page 118</p> <p> Note</p> <p>After all repair work, wipe the Clean Room robot free from particles with spirit on a lint free cloth.</p>	

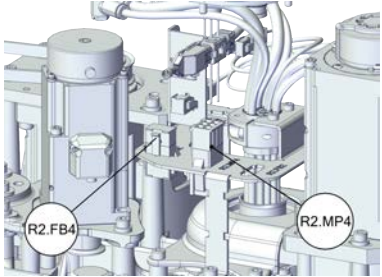

5 Repair

5.5.1 Replacing the inner arm

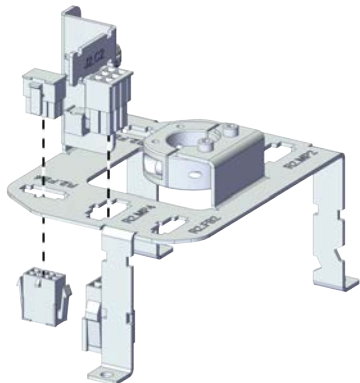

Continued

	Action	Note
2	Disconnect the axis-4 motor connectors. <ul style="list-style-type: none"> • R2.MP4 • R2.FB4 	 <p>xx2100000938</p>
3	Snap loose and remove the female head of the connectors from the bracket.  Note The harness are not visible due to the cleanness requirements of the illustration. They are still existing inside the cable ferrule in the actual situation.	 <p>xx2100000939</p>

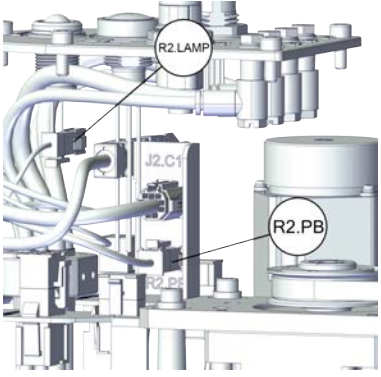

Disconnecting the connector for PB

	Action	Note
1	 DANGER Make sure that all supplies for electrical power, hydraulic pressure, and air pressure are turned off.	
2	 CAUTION For robots with protection type Clean Room Always cut the paint with a knife and grind the paint edge when disassembling parts of the robot! See Cut the paint or surface on the robot before replacing parts on page 118 .	

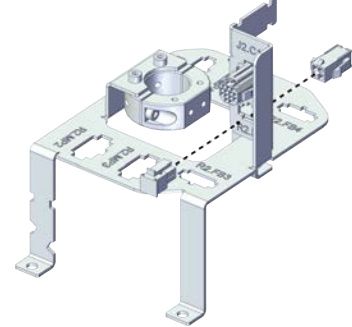
Continues on next page

	Action	Note
3	Disconnect the connector. <ul style="list-style-type: none"> • R2.PB • R2.LAMP 	 <p>xx2100001030</p>
4	Snap loose and remove the female head of the connector from the bracket.  Note The harness are not visible due to the cleanness requirements of the illustration. They are still existing inside the cable ferrule in the actual situation.	 <p>xx2100001031</p>

Pull out the process hub



	Action	Note
1	 DANGER Make sure that all supplies for electrical power, hydraulic pressure, and air pressure are turned off.	
2	 CAUTION For robots with protection type Clean Room Always cut the paint with a knife and grind the paint edge when disassembling parts of the robot! See Cut the paint or surface on the robot before replacing parts on page 118.	

Continues on next page



5 Repair

5.5.1 Replacing the inner arm

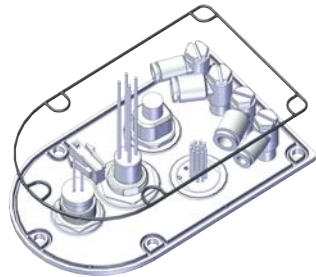
Continued

	Action	Note
3	<p>Take out the process hub.</p> <p> Note</p> <p>For robots with protection class IP54 (option 3350-540)</p> <p>For robots with protection type Clean Room (option 3351-1)</p> <p>Check the gasket for the process hub.</p> <p> Tip</p> <p>Replace the gasket if needed.</p> <p> CAUTION</p> <p>Be aware of the cabling that is attached to the cover! The cover can not be removed completely until the connectors are disconnected, as shown in following steps.</p>	<p>For robots with protection class IP54 (option 3350-540)</p> <p>For robots with protection type Clean Room (option 3351-1)</p>  <p>xx2100002438</p>

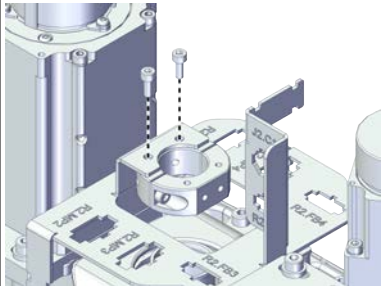

Removing the cable ferrule and bracket

	Action	Note
1	<p> DANGER</p> <p>Make sure that all supplies for electrical power, hydraulic pressure, and air pressure are turned off.</p>	
2	<p> CAUTION</p> <p>For robots with protection type Clean Room</p> <p>Always cut the paint with a knife and grind the paint edge when disassembling parts of the robot! See Cut the paint or surface on the robot before replacing parts on page 118.</p>	
3	<p>Remove the screws on the bracket to the cable ferrule to release the cable ferrule with cable.</p> <p> Note</p> <p>The harness are not visible due to the cleanness requirements of the illustration. They are still existing inside the cable ferrule in the actual situation.</p>	 <p>xx2100000940</p>

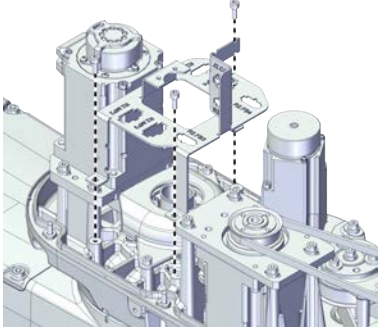
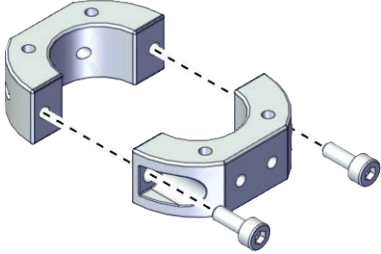
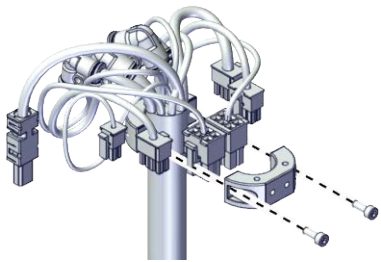
Continues on next page

	Action	Note
4	<p>Remove the screws on the bracket.</p> <p> Note</p> <p>The harness are not visible due to the cleanness requirements of the illustration. They are still existing inside the cable ferrule in the actual situation.</p>	 <p>xx210000941</p>
5	<p>Remove the screws on the cable ferrule and take the cable ferrule out.</p>	 <p>xx1800002842</p>  <p>xx1800002849</p>

Removing the gear-2 pulley protection cover

	Action	Note
1	<p> DANGER</p> <p>Make sure that all supplies for electrical power, hydraulic pressure, and air pressure are turned off.</p>	
2	<p> CAUTION</p> <p>For robots with protection type Clean Room Always cut the paint with a knife and grind the paint edge when disassembling parts of the robot! See Cut the paint or surface on the robot before replacing parts on page 118.</p>	

Continues on next page



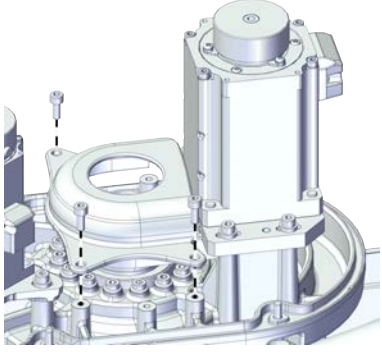

5 Repair

5.5.1 Replacing the inner arm

Continued

	Action	Note
3	Remove the screws on the pulley protection cover to release the pulley protection cover.	 <p>xx2100001047</p>

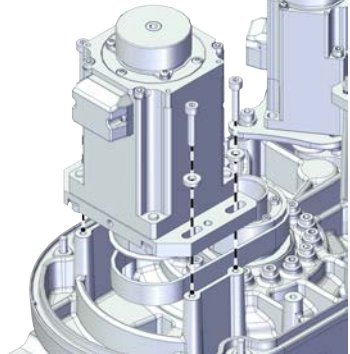
Removing the axis-2 motor sub-assembly

	Action	Note
1	 DANGER Make sure that all supplies for electrical power, hydraulic pressure, and air pressure are turned off.	
2	 CAUTION For robots with protection type Clean Room Always cut the paint with a knife and grind the paint edge when disassembling parts of the robot! See Cut the paint or surface on the robot before replacing parts on page 118 .	
3	Remove the screws and washers.	 <p>xx2100001046</p>
4	Remove the motor.  Tip Move the internal harness out of the way.	



Removing the axis-2 timing belt

	Action	Note
1	 DANGER Make sure that all supplies for electrical power, hydraulic pressure, and air pressure are turned off.	

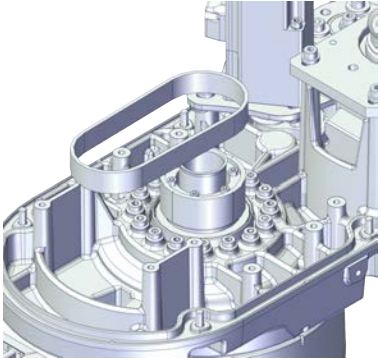
Continues on next page

	Action	Note
2	<p> CAUTION</p> <p>For robots with protection type Clean Room Always cut the paint with a knife and grind the paint edge when disassembling parts of the robot! See <i>Cut the paint or surface on the robot before replacing parts on page 118.</i></p>	
3	Remove the timing belt from the outer arm.	 <p>xx2100001048</p>

Removing the outer arm assembly

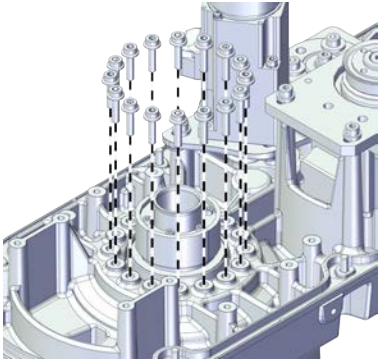
	Action	Note
1	<p> DANGER</p> <p>Make sure that all supplies for electrical power, hydraulic pressure, and air pressure are turned off.</p>	
2	<p> CAUTION</p> <p>For robots with protection type Clean Room Always cut the paint with a knife and grind the paint edge when disassembling parts of the robot! See <i>Cut the paint or surface on the robot before replacing parts on page 118.</i></p>	
3	Remove the screws on the axis -2 gear inside the outer arm.	 <p>xx2100001049</p>

Continues on next page



5 Repair

5.5.1 Replacing the inner arm

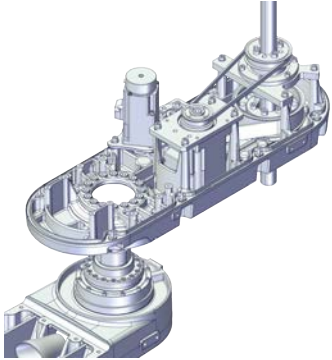

Continued

	Action	Note
4	Remove the outer arm assembly slightly.	 xx2100001050



Removing the axis-1 cover

	Action	Note
1	 DANGER Make sure that all supplies for electrical power, hydraulic pressure, and air pressure are turned off.	
2	 CAUTION For robots with protection type Clean Room Always cut the paint with a knife and grind the paint edge when disassembling parts of the robot! See Cut the paint or surface on the robot before replacing parts on page 118 .	

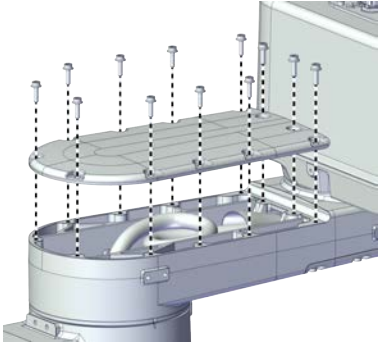
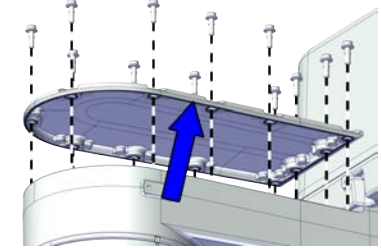
Continues on next page

	Action	Note
3	Remove the screws.	
4	<p>Remove the cover.</p> <p> Note</p> <p>For robots with protection class IP54 (option 3350-540)</p> <p>For robots with protection type Clean Room (option 3351-1)</p> <p>Remove the cover and check the gasket.</p> <p> Tip</p> <p>Replace the gasket if needed.</p>	<p>For robots with protection class IP30 (option 3350-300)</p>  <p>xx2100000942</p> <p>For robots with protection class IP54 (option 3350-540)</p> <p>For robots with protection type Clean Room (option 3351-1)</p>  <p>xx2100002428</p>

Removing the axis-2 cover



	Action	Note
1	<p> DANGER</p> <p>Make sure that all supplies for electrical power, hydraulic pressure, and air pressure are turned off.</p>	
2	<p> CAUTION</p> <p>For robots with protection type Clean Room</p> <p>Always cut the paint with a knife and grind the paint edge when disassembling parts of the robot! See Cut the paint or surface on the robot before replacing parts on page 118.</p>	

Continues on next page



5 Repair

5.5.1 Replacing the inner arm

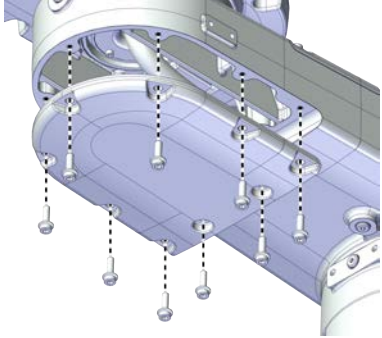
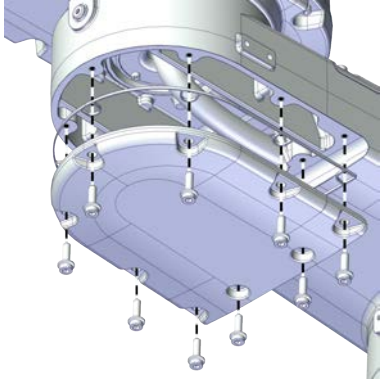



Continued

	Action	Note
3	Remove the screws.	For robots with protection class IP30 (option 3350-300)
4	Remove the cover.  Note For robots with protection class IP54 (option 3350-540) For robots with protection type Clean Room (option 3351-1) Remove the cover and check the gasket.  Tip Replace the gasket if needed.	 xx2100000943 For robots with protection class IP54 (option 3350-540) For robots with protection type Clean Room (option 3351-1)  xx2100002451

Removing the SMB cover

	Action	Note
1	 DANGER Make sure that all supplies for electrical power, hydraulic pressure, and air pressure are turned off.	
2	 ELECTROSTATIC DISCHARGE (ESD) The unit is sensitive to ESD. Before handling the unit read the safety information in section The unit is sensitive to ESD on page 49 .	

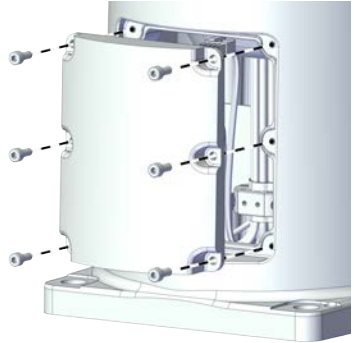
Continues on next page

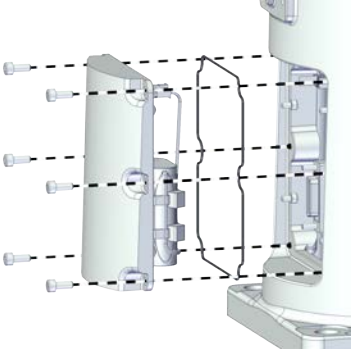
	Action	Note
3	<p> CAUTION</p> <p>For robots with protection type Clean Room Always cut the paint with a knife and grind the paint edge when disassembling parts of the robot! See <i>Cut the paint or surface on the robot before replacing parts on page 118.</i></p>	
4	<p>Remove the screws on the SMB cover to the base.</p> <p> Note</p> <p>For robots with protection type Clean Room (option 3351-1) Remove the stainless screws on the SMB cover to the base.</p>	<p>For robots with protection class IP30 (option 3350-300)</p> 
5	<p>Pull the SMB cover with the SMB unit assembly out together.</p> <p> Note</p> <p>For robots with protection class IP54 (option 3350-540) For robots with protection type Clean Room (option 3351-1) Check the gasket for the SMB cover.</p> <p> Tip</p> <p>Replace the gasket if needed.</p>	<p>xx2100000944</p> <p>For robots with protection class IP54 (option 3350-540) For robots with protection type Clean Room (option 3351-1)</p>  <p>xx2100002433</p>

Disconnecting the SMB cabling



	Action	Note
1	<p> DANGER</p> <p>Make sure that all supplies for electrical power, hydraulic pressure, and air pressure are turned off.</p>	

Continues on next page



5 Repair

5.5.1 Replacing the inner arm

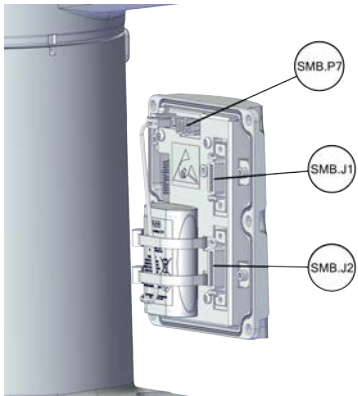

Continued

	Action	Note
2	 ELECTROSTATIC DISCHARGE (ESD) The unit is sensitive to ESD. Before handling the unit read the safety information in section The unit is sensitive to ESD on page 49 .	
3	 CAUTION For robots with protection type Clean Room Always cut the paint with a knife and grind the paint edge when disassembling parts of the robot! See Cut the paint or surface on the robot before replacing parts on page 118 .	
4	Cut the strips.	
5	Disconnect the connectors. <ul style="list-style-type: none"> • SMB.P7 • SMB.J1 • SMB.J2  Tip Take photos of the connector and cable position before disconnecting them, to have as a reference when reconnecting.	 xx2100000945

Removing the base plate/ rear plate

	Action	Note
1	 DANGER Make sure that all supplies for electrical power, hydraulic pressure, and air pressure are turned off.	
2	 CAUTION For robots with protection type Clean Room Always cut the paint with a knife and grind the paint edge when disassembling parts of the robot! See Cut the paint or surface on the robot before replacing parts on page 118 .	
3	Remove the screws on the base to the ground.	
4	Lay down the robot.	

Continues on next page

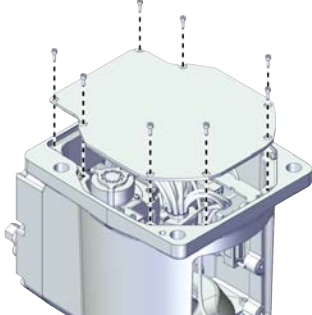
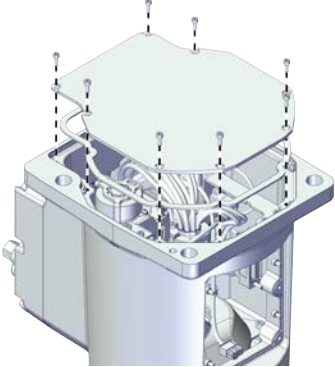

	Action	Note
5	For robot with rear outlet cable version, remove the screws on the base plate.	For rear outlet cable version:
6	<p>Remove the base plate.</p> <p> Note</p> <p>For robots with protection class IP54 (option 3350-540)</p> <p>For robots with protection type Clean Room (option 3351-1)</p> <p>Check the gasket for the base plate.</p> <p> Tip</p> <p>Replace the gasket if needed.</p>	<p>For robots with protection class IP30 (option 3350-300)</p>  <p>xx2100000946</p> <p>For robots with protection class IP54 (option 3350-540)</p> <p>For robots with protection type Clean Room (option 3351-1)</p>  <p>xx2100002434</p>

Continues on next page



5 Repair

5.5.1 Replacing the inner arm

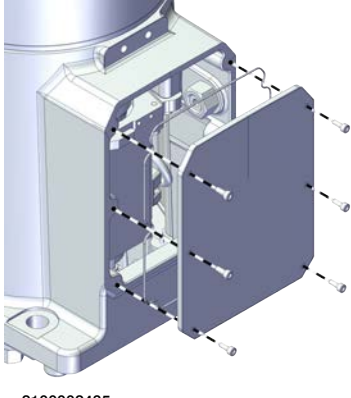
Continued

	Action	Note
7	For robot with underneath outlet cable version, remove the screws on the rear plate.	For underneath outlet cable version: For robots with protection class IP30 (option 3350-300)
8	Remove the rear plate.  Note For robots with protection class IP54 (option 3350-540) For robots with protection type Clean Room (option 3351-1) Check the gasket for the rear plate.  Tip Replace the gasket if needed.	
		 xx2100002435



Releasing the base bracket

	Action	Note
1	 DANGER Make sure that all supplies for electrical power, hydraulic pressure, and air pressure are turned off.	
2	 CAUTION For robots with protection type Clean Room Always cut the paint with a knife and grind the paint edge when disassembling parts of the robot! See Cut the paint or surface on the robot before replacing parts on page 118 .	

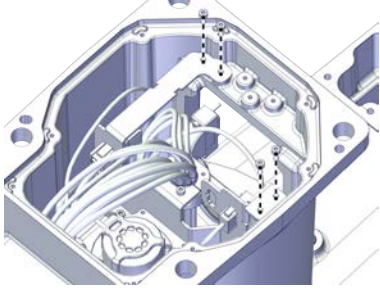
Continues on next page

	Action	Note
3	Remove the screws on the base bracket to the base.	 <p>xx210000948</p>

Disconnecting the grounding cable connectors

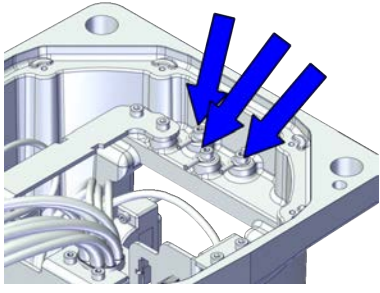
	Action	Note
1	 DANGER Make sure that all supplies for electrical power, hydraulic pressure, and air pressure are turned off.	
2	 CAUTION For robots with protection type Clean Room Always cut the paint with a knife and grind the paint edge when disassembling parts of the robot! See Cut the paint or surface on the robot before replacing parts on page 118 .	
3	Remove the three grounding cables from the bracket by unscrew the screws.	 <p>xx210000947</p>

Disconnecting the connectors for axis-1 motor



	Action	Note
1	 DANGER Make sure that all supplies for electrical power, hydraulic pressure, and air pressure are turned off.	

Continues on next page

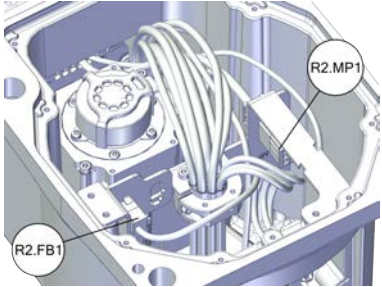

5 Repair

5.5.1 Replacing the inner arm

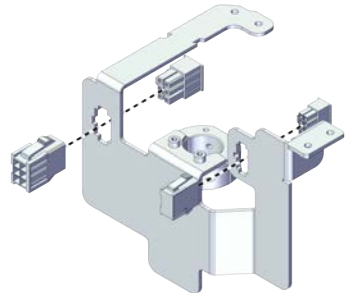
Continued

	Action	Note
2	 CAUTION For robots with protection type Clean Room Always cut the paint with a knife and grind the paint edge when disassembling parts of the robot! See <i>Cut the paint or surface on the robot before replacing parts on page 118.</i>	
3	Disconnect the connectors. <ul style="list-style-type: none"> • R2.MP1 • R2.FB1 	 <p>xx2100000949</p>
4	Snap loose and remove the female head of the connectors from the bracket.  Note The harness are not visible due to the cleanliness requirements of the illustration. They are still existing inside the cable ferrule in the actual situation.	 <p>xx2100000950</p>



Removing the bracket

	Action	Note
1	 DANGER Make sure that all supplies for electrical power, hydraulic pressure, and air pressure are turned off.	
2	 CAUTION For robots with protection type Clean Room Always cut the paint with a knife and grind the paint edge when disassembling parts of the robot! See <i>Cut the paint or surface on the robot before replacing parts on page 118.</i>	

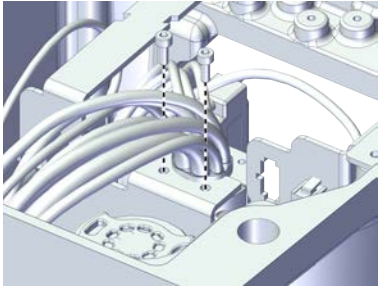
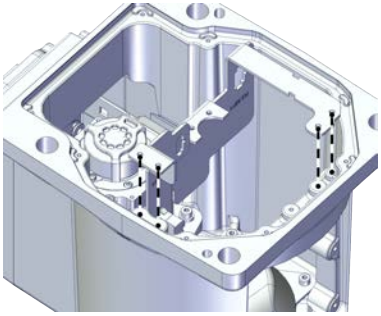
Continues on next page

	Action	Note
3	Release the cable ferrule from the bracket.	 <p>xx2100000951</p>
4	Remove the bracket.	 <p>xx2100000952</p>



Removing the main harness from the axis -2 gearbox position

	Action	Note
1	 <p>DANGER</p> <p>Make sure that all supplies for electrical power, hydraulic pressure, and air pressure are turned off.</p>	
2	 <p>CAUTION</p> <p>For robots with protection type Clean Room Always cut the paint with a knife and grind the paint edge when disassembling parts of the robot! See Cut the paint or surface on the robot before replacing parts on page 118.</p>	



5 Repair

5.5.1 Replacing the inner arm

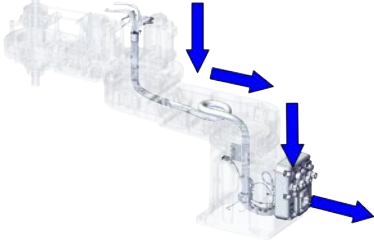
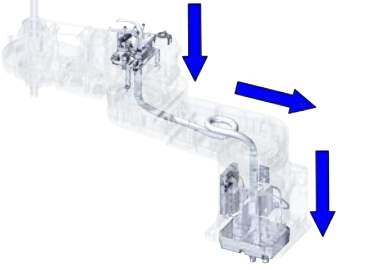
Continued

	Action	Note
3	<p>Pull the internal harness out of the outer arm from the centre of the axis-2 gearbox.</p> <p> Tip Wrap the connectors with the masking tape.</p> <p> Tip Take photos of the connector and cable position before disconnecting them, to have as a reference when reconnecting.</p>	<p>For rear outlet cable version:</p>  <p>xx2100000954</p> <p>For underneath outlet cable version:</p>  <p>xx2100001203</p>



Removing the main harness from the axis -1 gearbox position

	Action	Note
1	<p> DANGER</p> <p>Make sure that all supplies for electrical power, hydraulic pressure, and air pressure are turned off.</p>	
2	<p> CAUTION</p> <p>For robots with protection type Clean Room Always cut the paint with a knife and grind the paint edge when disassembling parts of the robot! See Cut the paint or surface on the robot before replacing parts on page 118.</p>	

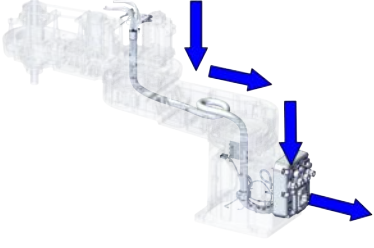
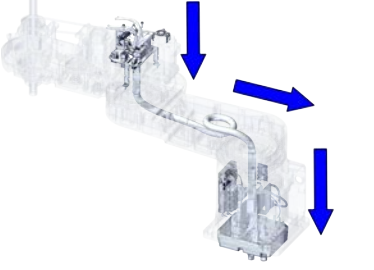
Continues on next page

	Action	Note
3	<p>Pull the internal harness out of the inner arm from the sleeve of the axis-1 gearbox.</p> <p> Tip</p> <p>Wrap the connectors with the masking tape.</p>	<p>For rear outlet cable version:</p>  <p>xx2100000954</p> <p>For underneath outlet cable version:</p>  <p>xx2100001203</p>

Removing the main harness



	Action	Note
1	<p> DANGER</p> <p>Make sure that all supplies for electrical power, hydraulic pressure, and air pressure are turned off.</p>	
2	<p> CAUTION</p> <p>For robots with protection type Clean Room</p> <p>Always cut the paint with a knife and grind the paint edge when disassembling parts of the robot! See Cut the paint or surface on the robot before replacing parts on page 118.</p>	

Continues on next page



5 Repair

5.5.1 Replacing the inner arm

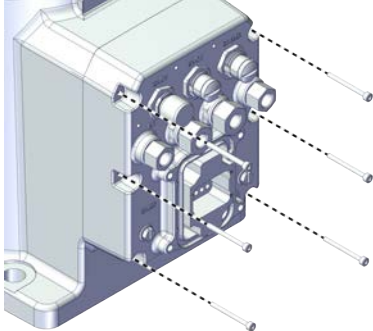
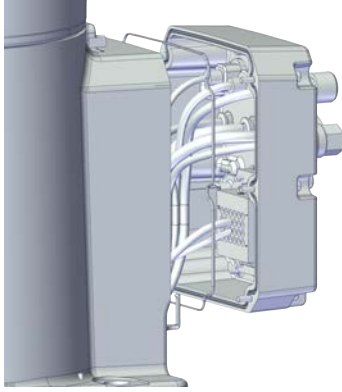
Continued

	Action	Note
3	For robot with rear outlet cable version, remove the screws on the main harness to the base.	For rear outlet cable version:
4	<p>Remove the main harness.</p> <p> Note</p> <p>For robots with protection class IP54 (option 3350-540)</p> <p>For robots with protection type Clean Room (option 3351-1)</p> <p>Check the gasket for the main harness.</p> <p> Tip</p> <p>Replace the gasket if needed.</p>	<p>For robots with protection class IP30 (option 3350-300)</p>  <p>xx2100000953</p> <p>For robots with protection class IP54 (option 3350-540)</p> <p>For robots with protection type Clean Room (option 3351-1)</p>  <p>xx2100002436</p>

Continues on next page

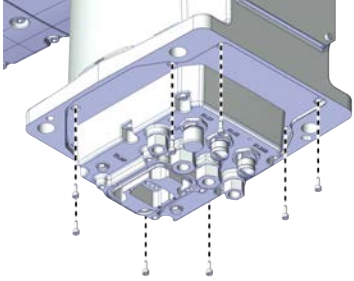
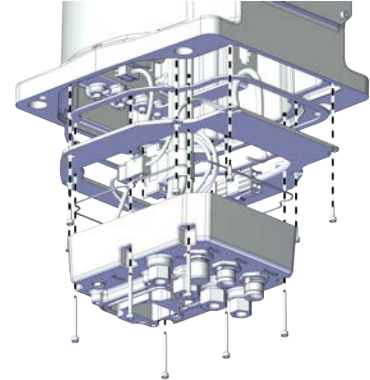
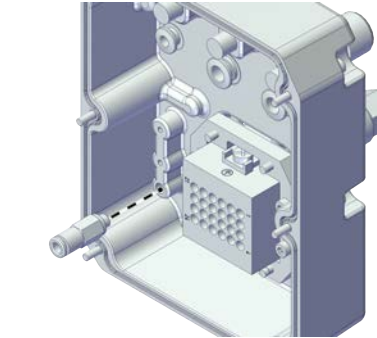
	Action	Note
5	For robot with underneath outlet cable version, remove the screws on the main harness assembly.	For underneath outlet cable version:
6	<p>Remove the main harness assembly.</p> <p> Note</p> <p>For robots with protection class IP54 (option 3350-540)</p> <p>For robots with protection type Clean Room (option 3351-1)</p> <p>Check the gasket for the main harness assembly.</p> <p> Tip</p> <p>Replace the gasket if needed.</p> <p> Note</p> <p>Remove the bottom plate from the main harness if needed.</p>	<p>For robots with protection class IP30 (option 3350-300)</p>  <p>xx2100001204</p> <p>For robots with protection class IP54 (option 3350-540)</p> <p>For robots with protection type Clean Room (option 3351-1)</p>  <p>xx2100002437</p>
7	<p>For robots with protection type Clean Room (option 3351-1)</p> <p>Remove the one way valve by unscrewing it.</p>	 <p>xx2200000281</p>

Removing the pulley protection cover

	Action	Note
1	<p> DANGER</p> <p>Make sure that all supplies for electrical power, hydraulic pressure, and air pressure are turned off.</p>	

Continues on next page



5 Repair

5.5.1 Replacing the inner arm

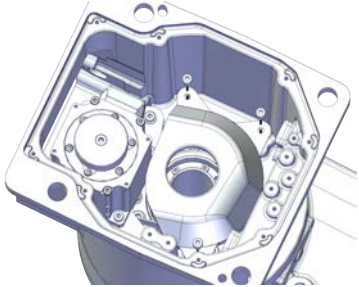
Continued

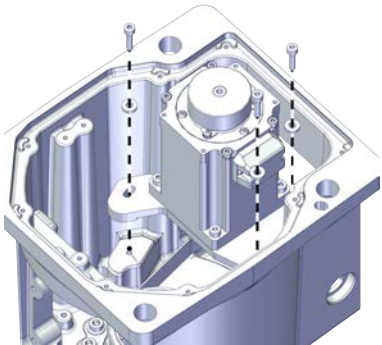

	Action	Note
2	 CAUTION For robots with protection type Clean Room Always cut the paint with a knife and grind the paint edge when disassembling parts of the robot! See Cut the paint or surface on the robot before replacing parts on page 118 .	
3	Remove the screws on the pulley protection cover to the base.	 xx2100001037
4	Remove the pulley protection cover.	

Removing the axis-1 motor sub-assembly



	Action	Note
1	 DANGER Make sure that all supplies for electrical power, hydraulic pressure, and air pressure are turned off.	
2	 CAUTION For robots with protection type Clean Room Always cut the paint with a knife and grind the paint edge when disassembling parts of the robot! See Cut the paint or surface on the robot before replacing parts on page 118 .	
3	Remove the screws and washers.	 xx2100001038
4	Remove the motor.	

Continues on next page

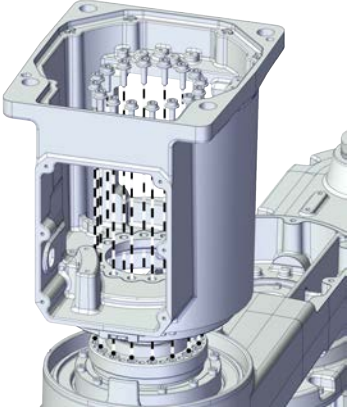
Removing the base from the axis-1 gear unit sub-assembly

	Action	Note
1	 DANGER Make sure that all supplies for electrical power, hydraulic pressure, and air pressure are turned off.	
2	 CAUTION For robots with protection type Clean Room Always cut the paint with a knife and grind the paint edge when disassembling parts of the robot! See Cut the paint or surface on the robot before replacing parts on page 118 .	
3	Remove the screws and washers on the base to the axis-1 gear unit.	 xx2100001039
4	Remove the base.	

Removing the axis-2 gear unit sub-assembly



	Action	Note
1	 DANGER Make sure that all supplies for electrical power, hydraulic pressure, and air pressure are turned off.	
2	 CAUTION For robots with protection type Clean Room Always cut the paint with a knife and grind the paint edge when disassembling parts of the robot! See Cut the paint or surface on the robot before replacing parts on page 118 .	

Continues on next page

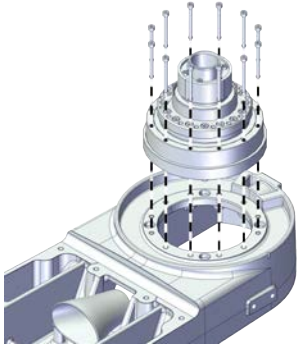

5 Repair

5.5.1 Replacing the inner arm

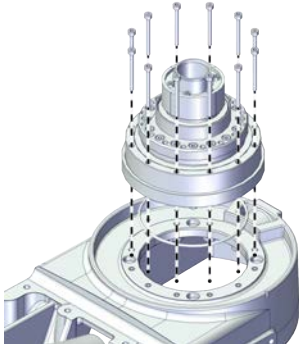



Continued

	Action	Note
3	Remove the screws on the gear to the inner arm.	<p>For robots with protection class IP30 (option 3350-300)</p>  <p>xx2100001182</p> <p>For robots with protection class IP54 (option 3350-540) For robots with protection type Clean Room (option 3351-1) Remove the gear unit and the O-ring through the cable slightly.</p> <p> Tip</p> <p>Check the O-ring and replace it if needed.</p> <p> Tip</p> <p>Wrap the connectors with the masking tape.</p>  <p>xx2100002439</p>
4	Remove the gear unit.	

Removing the axis-1 gear unit sub-assembly

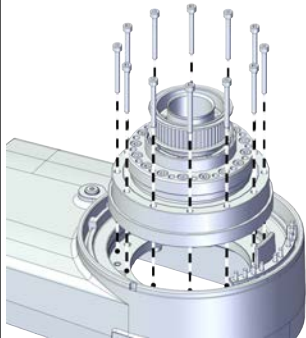
	Action	Note
1	 DANGER Make sure that all supplies for electrical power, hydraulic pressure, and air pressure are turned off.	
2	 CAUTION For robots with protection type Clean Room Always cut the paint with a knife and grind the paint edge when disassembling parts of the robot! See Cut the paint or surface on the robot before replacing parts on page 118 .	

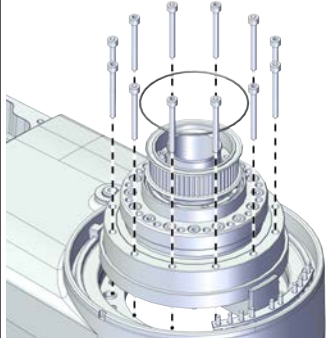

Continues on next page

	Action	Note
3	Remove the screws on the gear to the inner arm.	<p>For robots with protection class IP30 (option 3350-300)</p>  <p>xx2100001130</p> <p>For robots with protection class IP54 (option 3350-540) For robots with protection type Clean Room (option 3351-1) Remove the gear unit and the O-ring through the cable slightly.</p> <p> Note</p> <p>For robots with protection class IP54 (option 3350-540) For robots with protection type Clean Room (option 3351-1) Remove the gear unit and the O-ring through the cable slightly.</p> <p> Tip</p> <p>Check the O-ring and replace it if needed.</p> <p> Tip</p> <p>Wrap the connectors with the masking tape.</p> <p>For robots with protection class IP54 (option 3350-540) For robots with protection type Clean Room (option 3351-1)</p>  <p>xx2100002440</p>
4	Remove the gear unit.	

Refitting the inner arm

Use these procedures to refit the inner arm.

Refitting the axis-2 gear unit sub-assembly to the inner arm



	Action	Note
1	<p>For robots with protection type Clean Room: Clean the joints that have been opened and wipe the parts free from particles with spirit on a lint free. See Cut the paint or surface on the robot before replacing parts on page 118</p> <p> Note</p> <p>After all repair work, wipe the Clean Room robot free from particles with spirit on a lint free cloth.</p>	
2	<p> CAUTION</p> <p>Whenever parting/mating motor and gearbox, the gears may be damaged if excessive force is used.</p>	

Continues on next page

5 Repair

5.5.1 Replacing the inner arm

Continued

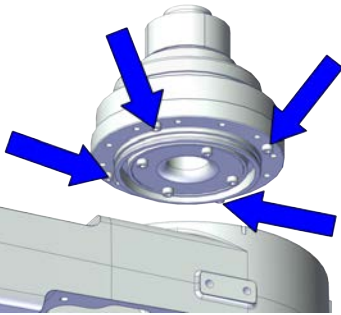
	Action	Note
3	<p>Refit the gear unit according to the location screws.</p> <p> Note</p> <p>For robots with protection class IP54 (option 3350-540) For robots with protection type Clean Room (option 3351-1) Refit the gear unit and the O-ring according to the location pin.</p> <p> Tip</p> <p>Check the O-ring and replace it if needed.</p> <p> Tip</p> <p>When the gear unit is in the right position, you can hear a clear "Click".</p>	 <p>xx2100001183</p>

Continues on next page

5.5.1 Replacing the inner arm

Continued

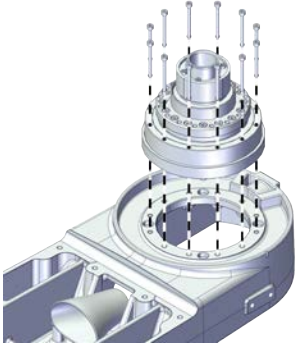
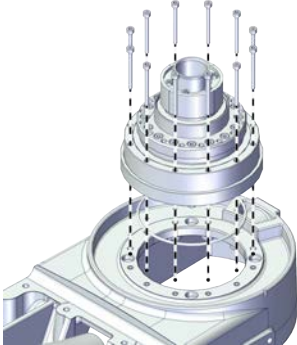
	Action	Note
4	Refit the screws.	<p>Screws: Hex socket head cap screw M3x30 12.9 Lafre 2C2B/FC6.9 (12 pcs)</p> <p>For 450: Tightening torque: 1.6 Nm ±3%</p> <p>For 550/650: Tightening torque: 1.8 Nm ±3%</p> <p>For robots with protection class IP30 (option 3350-300)</p>  <p>xx2100001182</p> <p>For robots with protection class IP54 (option 3350-540)</p> <p>For robots with protection type Clean Room (option 3351-1)</p>  <p>xx2100002439</p>

Refitting the axis-1 gear unit sub-assembly to the inner arm





	Action	Note
1	<p>For robots with protection type Clean Room: Clean the joints that have been opened and wipe the parts free from particles with spirit on a lint free. See Cut the paint or surface on the robot before replacing parts on page 118</p> <p> Note</p> <p>After all repair work, wipe the Clean Room robot free from particles with spirit on a lint free cloth.</p>	

Continues on next page

5 Repair

5.5.1 Replacing the inner arm

Continued

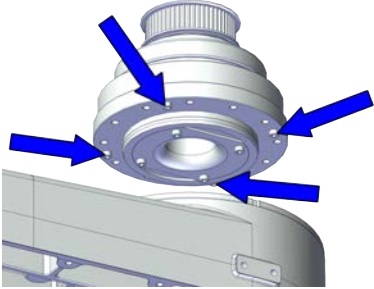
	Action	Note
2	 CAUTION Whenever parting/mating motor and gearbox, the gears may be damaged if excessive force is used.	
3	<p>Refit the gear unit according to the location screws through the cable.</p>  Note For robots with protection class IP54 (option 3350-540) For robots with protection type Clean Room (option 3351-1) Refit the gear unit and the O-ring according to the location pin through the cable.  Tip Check the O-ring and replace it if needed.  Tip When the gear unit is in the right position, you can hear a clear "Click".  Tip Wrap the connectors with the masking tape.	 xx2100001131

Continues on next page

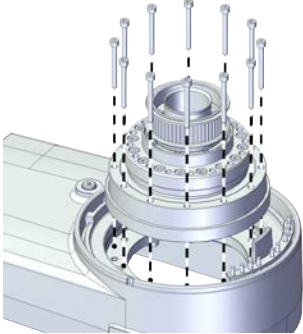
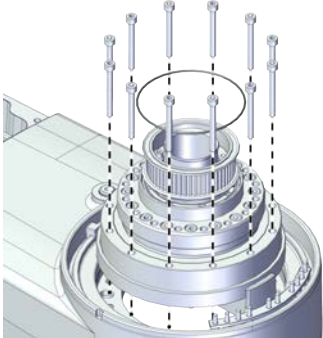
	Action	Note
4	Refit the screws.	<p>Screws: Hex socket head cap screw M4x35 12.9 Lafre 2C2B/FC6.9 (12 pcs) Tightening torque: 4.7 Nm \pm3% For robots with protection class IP30 (option 3350-300)</p>  <p>xx2100001130</p> <p>For robots with protection class IP54 (option 3350-540) For robots with protection type Clean Room (option 3351-1)</p>  <p>xx2100002440</p>

Refitting the base

	Action	Note
1	<p>For robots with protection type Clean Room: Clean the joints that have been opened and wipe the parts free from particles with spirit on a lint free. See Cut the paint or surface on the robot before replacing parts on page 118</p> <p> Note</p> <p>After all repair work, wipe the Clean Room robot free from particles with spirit on a lint free cloth.</p>	

Continues on next page

5 Repair

5.5.1 Replacing the inner arm

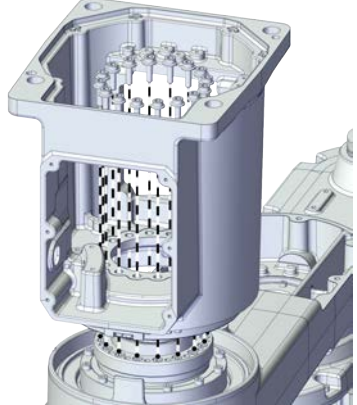

Continued

	Action	Note
2	Refit the base to the axis-1 gearbox as the illustration.	<p>Screws: Hex socket head cap screw M5x16 12.9 Lafre 2C2B/FC6.9 (16 pcs)</p> <p>Washers: Plain washer 11x5.3x1.2 Steel (16 pcs)</p> <p>Tightening torque: 8.5 Nm±10%</p>  <p>xx2100001039</p>
3	Refit the screws.	

Refitting the axis-1 motor sub-assembly

	Action	Note
1	<p>For robots with protection type Clean Room: Clean the joints that have been opened and wipe the parts free from particles with spirit on a lint free. See Cut the paint or surface on the robot before replacing parts on page 118</p> <p> Note</p> <p>After all repair work, wipe the Clean Room robot free from particles with spirit on a lint free cloth.</p>	
2	Put the timing belt into the pulley on the gear.	

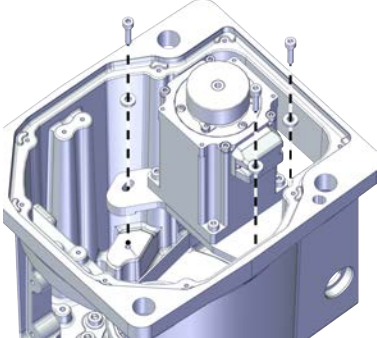
Continues on next page

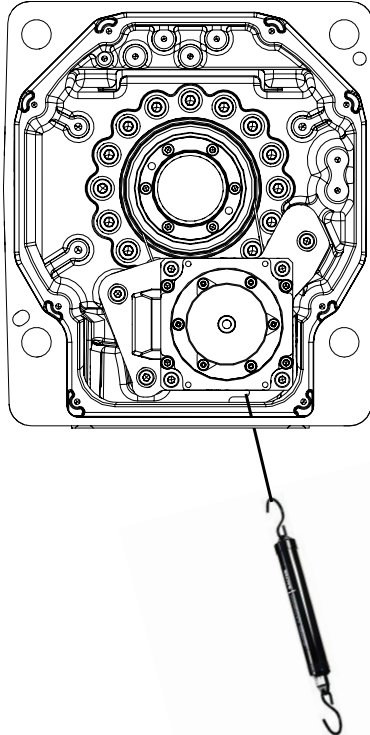
	Action	Note
3	Refit the motor and refit the timing belt to the motor. Ensure that the belt runs correctly in the grooves.	Screws: Hex socket head cap screw M4x16 12.9 Lafre 2C2B/FC6.9 (3 pcs) Washers: Plain washer machining 4.2x9x2 steel (3 pcs) Tightening torque: 2.8 Nm ±10%
4	Refit the screws and washers without fully tightened.	 <p>xx2100001038</p> <p>Timing belt A1: 3HAC070449-001</p>
5	Hang a strap to the hook on the motor.	
6	Use a handheld dynamometer hooking to the strap and pull the dynamometer to make the tension falling in the allowed force range.  Note During the measurement, make sure that all interferences that may affect the force are removed. Pay attention to the force application direction.	Used belt: 51.1 New belt:90  <p>xx2100001043</p>



5 Repair

5.5.1 Replacing the inner arm

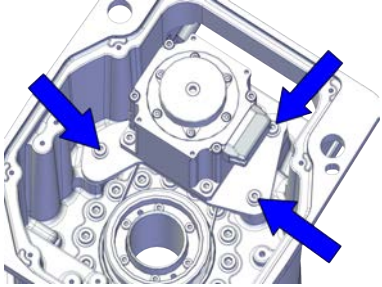
Continued



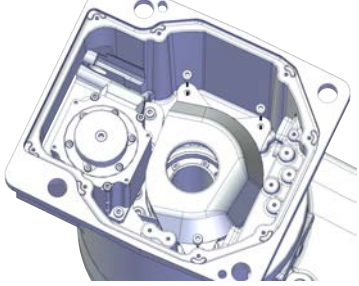

	Action	Note
7	Fasten the screws to the recommended tightening torque.	Tightening torque: 2.8 Nm \pm 10%  xx2100001044
8	Use a sonic tension meter to measure the timing belt tension.	Used belt: 308 New belt:250
9	If the timing belt tension does not meet the requirement, loosen the motor screws and readjust.	

Refitting the pulley protection cover

	Action	Note
1	 DANGER Make sure that all supplies for electrical power, hydraulic pressure, and air pressure are turned off.	
2	 CAUTION For robots with protection type Clean Room Always cut the paint with a knife and grind the paint edge when disassembling parts of the robot! See Cut the paint or surface on the robot before replacing parts on page 118 .	
3	Refit the pulley protection cover.	Screws: Hex socket head cap screw M4x10 12.9 Lafre 2C2B/FC6.9 (8 pcs) Tightening torque: 0.8 Nm  xx2100001037
4	Secure the screws on the pulley protection cover to the base.	

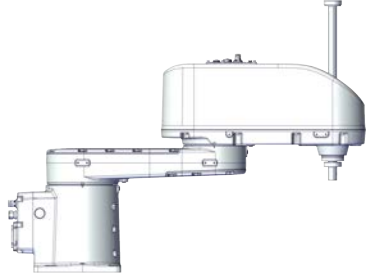
Continues on next page

Inserting the main harness through the axis -1 gearbox position

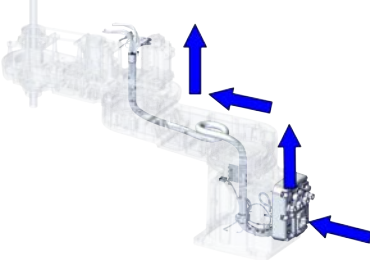
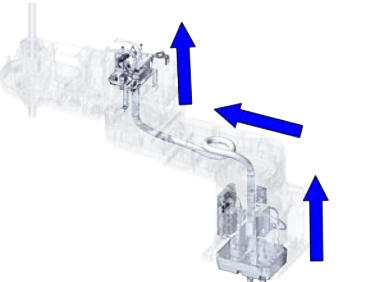
	Action	Note
1	<p>For robots with protection type Clean Room: Clean the joints that have been opened and wipe the parts free from particles with spirit on a lint free. See Cut the paint or surface on the robot before replacing parts on page 118</p> <p> Note</p> <p>After all repair work, wipe the Clean Room robot free from particles with spirit on a lint free cloth.</p>	
2	<p>Make sure that the robot is at zero position.</p>	 <p>xx2100000930</p>
3	<p>Insert the internal harness into the inner arm through the sleeve of the axis-1 gearbox from the base.</p> <p> Tip</p> <p>Wrap the connectors with the masking tape.</p> <p> Tip</p> <p>The air hoses should face the axis-1 motor.</p> <p> CAUTION</p> <p>Make sure that no cables or hoses are twisted or strained. Reroute if necessary.</p>	<p>For rear outlet cable version:</p>  <p>xx2100000955</p> <p>For underneath outlet cable version:</p>  <p>xx2100001206</p>







Continues on next page

5 Repair

5.5.1 Replacing the inner arm

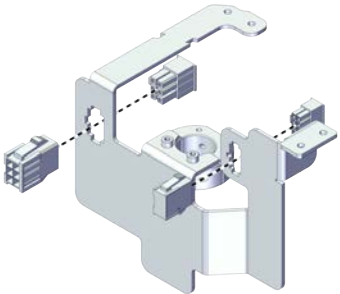

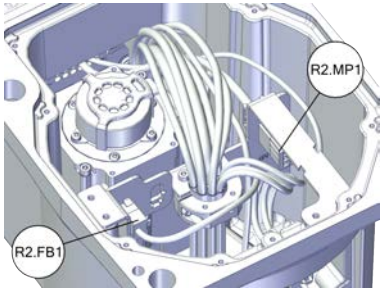
Continued

Reconnecting the connectors for axis-1 motor

	Action	Note
1	<p>For robots with protection type Clean Room: Clean the joints that have been opened and wipe the parts free from particles with spirit on a lint free. See Cut the paint or surface on the robot before replacing parts on page 118</p> <p> Note</p> <p>After all repair work, wipe the Clean Room robot free from particles with spirit on a lint free cloth.</p>	
2	<p>Insert the female head of the connectors to the bracket accordingly.</p> <p> Tip</p> <p>The mistake proofing measure has been applied to the connectors, the connectors may be damaged if excessive force is used.</p> <p> Note</p> <p>The harness are not visible due to the cleanness requirements of the illustration. They are still existing inside the cable ferrule in the actual situation.</p>	 <p>xx2100000950</p>
3	<p>Reconnect the connectors.</p> <ul style="list-style-type: none"> • R2.MP1 • R2.FB1 <p> Tip</p> <p>See the number markings on the connectors for help to find the corresponding connector.</p>	 <p>xx2100000949</p>
4	<p>Route the cabling behind the axis-1 motor.</p> <p> CAUTION</p> <p>Correct cable routing is highly important. If the cables are routed and secured incorrectly the cables can be damaged.</p>	

Continues on next page

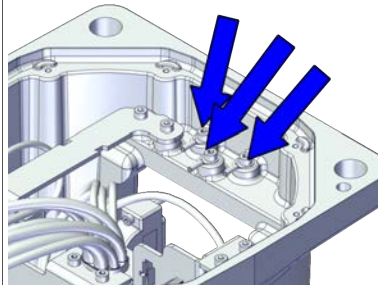
Reconnecting the grounding cable connectors

	Action	Note
1	<p>For robots with protection type Clean Room: Clean the joints that have been opened and wipe the parts free from particles with spirit on a lint free. See Cut the paint or surface on the robot before replacing parts on page 118</p> <p> Note</p> <p>After all repair work, wipe the Clean Room robot free from particles with spirit on a lint free cloth.</p>	
2	<p>Secure the three grounding cables to the bracket with the screw.</p>	<p>Screws: Hex socket head cap screw M3x5 12.9 Lafre 2C2B/FC6.9 (3 pcs) Tightening torque: 1.5 Nm \pm10%</p>  <p>xx2100000947</p>
3	<p>Route and secure the cabling with cable straps if needed.</p> <p> CAUTION</p> <p>Correct cable routing is highly important. If the cables are routed and secured incorrectly the cables can be damaged.</p>	

Refitting the cable ferrule in the base



	Action	Note
1	<p>For robots with protection type Clean Room: Clean the joints that have been opened and wipe the parts free from particles with spirit on a lint free. See Cut the paint or surface on the robot before replacing parts on page 118</p> <p> Note</p> <p>After all repair work, wipe the Clean Room robot free from particles with spirit on a lint free cloth.</p>	

Continues on next page



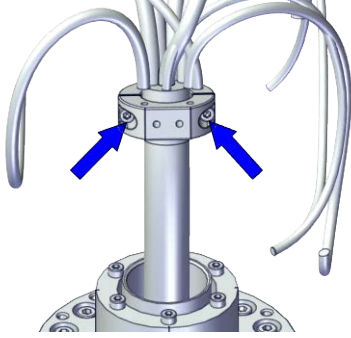

5 Repair

5.5.1 Replacing the inner arm

Continued

	Action	Note
2	<p>Refit the cable ferrule to the cable and secure it with the screw.</p> <p> Tip</p> <p>The cable ferrule should be refitted at the position where the tape is wrapped.</p> <p> Tip</p> <p>Align all the cable ferrules so that the cable is in a natural bending position to avoid twisting.</p>	<p>Screws: Hex socket head cap screw M3x8 12.9 Lafre 2C2B/FC6.9 (2 pcs)</p> <p>Tightening torque: 1.2 Nm \pm10%</p>  <p>xx1800002900</p>

Refitting the base bracket

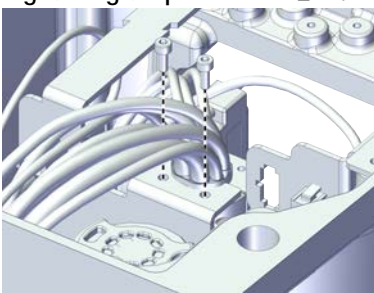

	Action	Note
1	<p> DANGER</p> <p>Make sure that all supplies for electrical power, hydraulic pressure, and air pressure are turned off.</p>	
2	<p> CAUTION</p> <p>For robots with protection type Clean Room</p> <p>Always cut the paint with a knife and grind the paint edge when disassembling parts of the robot! See Cut the paint or surface on the robot before replacing parts on page 118.</p>	
3	<p>Lay the main harness in a natural state without distortion.</p> <p>Secure the cable ferrule to the bracket.</p> <p> Tip</p> <p>Align all the cable ferrules so that the cable is in a natural bending position to avoid twisting.</p> <p> Note</p> <p>The harness are not visible due to the cleanliness requirements of the illustration. They are still existing inside the cable ferrule in the actual situation.</p>	<p>Screws: Hex socket head cap screw M3x8 12.9 Lafre 2C2B/FC6.9 (2 pcs)</p> <p>Tightening torque: 1.2 Nm \pm10%</p>  <p>xx2100000951</p>

Continues on next page

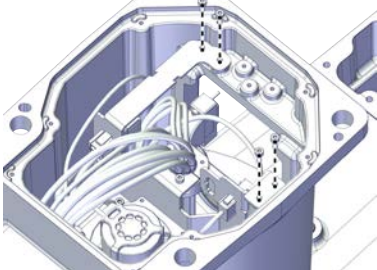
Continued

	Action	Note
4	Refit the base bracket to the base and secure with the screws.	Screws: Hex socket head cap screw M3x8 12.9 Lafre 2C2B/FC6.9 (4 pcs) Tightening torque: 1.2 Nm \pm 10%  xx2100000948

Refitting the SMB cover

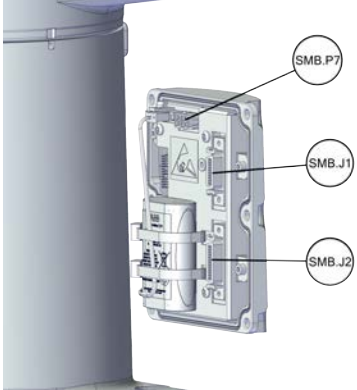

	Action	Note
1	For robots with protection type Clean Room: Clean the joints that have been opened and wipe the parts free from particles with spirit on a lint free. See Cut the paint or surface on the robot before replacing parts on page 118  Note After all repair work, wipe the Clean Room robot free from particles with spirit on a lint free cloth.	
2	Reconnect the connectors. <ul style="list-style-type: none"> • SMB.P7 • SMB.J1 • SMB.J2  Tip Take photos of the connector and cable position before disconnecting them, to have as a reference when reconnecting.	 xx2100000945

Continues on next page

5 Repair

5.5.1 Replacing the inner arm

Continued

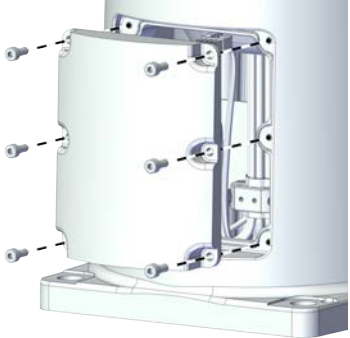
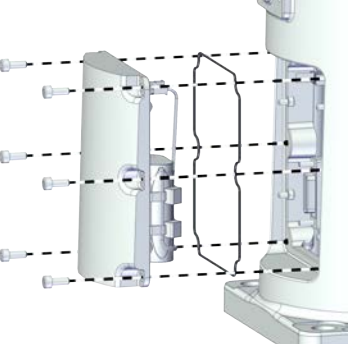
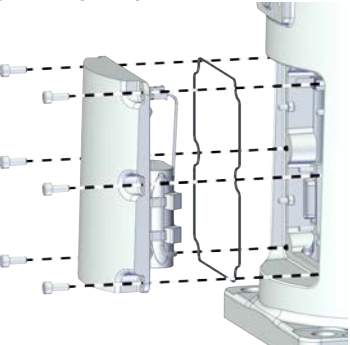
	Action	Note
3	<p>Refit the SMB cover assembly.</p> <p> Note</p> <p>For robots with protection class IP54 (option 3350-540)</p> <p>For robots with protection type Clean Room (option 3351-1)</p> <p>Check the gasket for the SMB cover.</p> <p> Tip</p> <p>Replace the gasket if needed.</p>	<p>For robots with protection class IP30 (option 3350-300)</p> <p>Screws: Hex socket head cap screw M4x10 12.9 Lafre 2C2B/FC6.9 (6 pcs)</p> <p>Tightening torque: 2.6 Nm</p> 
4	<p>Secure the SMB cover to the base with the screws.</p>	<p>xx210000944</p> <p>For robots with protection type Clean Room (option 3351-1)</p> <p>Screws: Stainless Screw Hexagon Socket Head Cap, Clean Room 3HAC075438-001 (6 pcs)</p> <p>Tightening torque: 2.6 Nm</p>  <p>xx2100002433</p> <p>For robots with protection class IP54 (option 3350-540)</p> <p>Screws: Hex socket head cap screw M4x10 12.9 Lafre 2C2B/FC6.9 (6 pcs)</p> <p>Tightening torque: 2.6 Nm</p>  <p>xx2100002433</p>

Continues on next page

Refitting the main harness

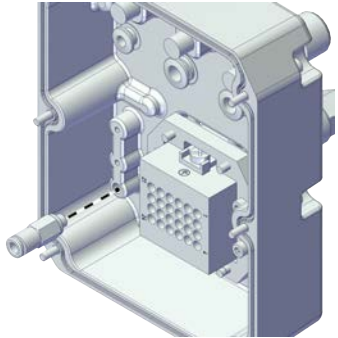
	Action	Note
1	<p>For robots with protection type Clean Room: Clean the joints that have been opened and wipe the parts free from particles with spirit on a lint free. See Cut the paint or surface on the robot before replacing parts on page 118</p> <p> Note</p> <p>After all repair work, wipe the Clean Room robot free from particles with spirit on a lint free cloth.</p>	
2	<p>For robots with protection type Clean Room (option 3351-1) Refit the one way valve by screwing it into the main harness assembly.</p>	 <p>xx2200000281</p>

Continues on next page

5 Repair

5.5.1 Replacing the inner arm

Continued

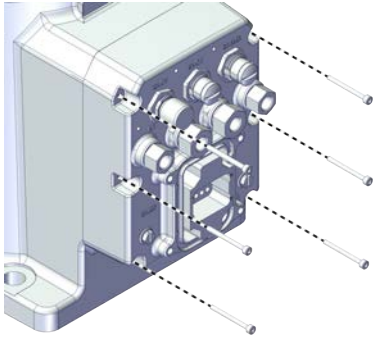
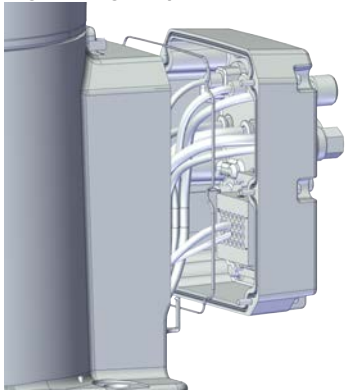
	Action	Note
3	For rear outlet cable version, refit the main harness to the base.	For rear outlet cable version: For robots with protection class IP30 (option 3350-300)
4	Secure with the screws.	Screws: Hex socket head cap screw M3x30 12.9 Lafre 2C2B/FC6.9 (6 pcs) Tightening torque: 1.2 Nm \pm 10%  xx2100000953 For robots with protection class IP54 (option 3350-540) For robots with protection type Clean Room (option 3351-1) Screws: Hex socket head cap screw M3x30 12.9 Lafre 2C2B/FC6.9 (6 pcs) Tightening torque: 1.2 Nm \pm 10%  xx2100002436

Continues on next page

5.5.1 Replacing the inner arm

Continued

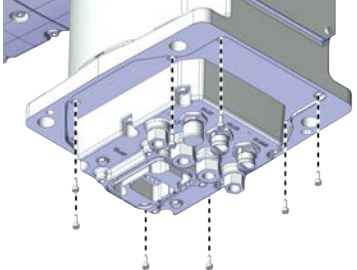
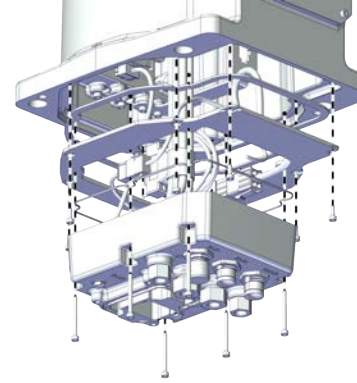
	Action	Note
5	<p>For underneath outlet cable version, refit the main harness assembly to the base.</p> <p> Note</p> <p>Refit the bottom plate to the main harness if needed.</p>	<p>For underneath outlet cable version:</p> <p>For robots with protection class IP30 (option 3350-300)</p> <p>Screws: Hex socket head cap screw M3x30 12.9 Lafre 2C2B/FC6.9 (8 pcs)</p> <p>Tightening torque: 1.2 Nm ±10%</p>
6	<p>Secure with the screws.</p>	 <p>xx2100001204</p> <p>For robots with protection class IP54 (option 3350-540)</p> <p>For robots with protection type Clean Room (option 3351-1)</p> <p>Screws: Hex socket head cap screw M3x30 12.9 Lafre 2C2B/FC6.9 (8 pcs)</p> <p>Tightening torque: 1.2 Nm ±10%</p>  <p>xx2100002437</p>

Refitting the base plate/ rear plate

	Action	Note
1	<p>For robots with protection type Clean Room:</p> <p>Clean the joints that have been opened and wipe the parts free from particles with spirit on a lint free. See Cut the paint or surface on the robot before replacing parts on page 118</p> <p> Note</p> <p>After all repair work, wipe the Clean Room robot free from particles with spirit on a lint free cloth.</p>	

Continues on next page





5 Repair

5.5.1 Replacing the inner arm

Continued

	Action	Note
2	Apply grease to the internal harness, cover all moving area of the harness.	

Continues on next page

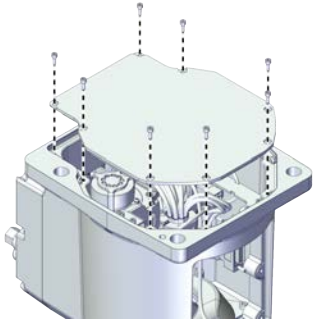
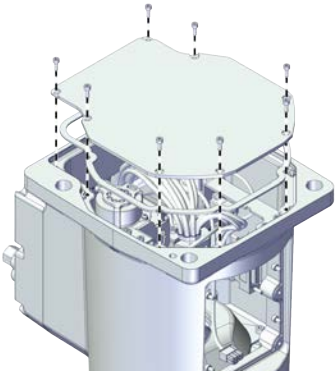
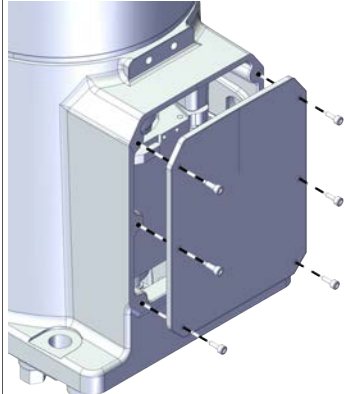
	Action	Note
3	<p>For rear outlet cable version, refit the base plate to the base.</p> <p> Note</p> <p>For robots with protection class IP54 (option 3350-540) For robots with protection type Clean Room (option 3351-1) Check the gasket for the base plate before refitting the base plate.</p> <p> Tip</p> <p>Replace the gasket if needed.</p> <p>For underneath outlet cable version, refit the rear plate to the base.</p> <p> Note</p> <p>For robots with protection class IP54 (option 3350-540) For robots with protection type Clean Room (option 3351-1) Check the gasket for the rear plate before refitting the rear plate.</p> <p> Tip</p> <p>Replace the gasket if needed.</p>	<p>Screws: Hex socket head cap screw M3x30 12.9 Lafre 2C2B/FC6.9 (6 pcs) Tightening torque: 1.2 Nm ±10% For rear outlet cable version: For robots with protection class IP30 (option 3350-300)</p>  <p>xx210000946</p> <p>For robots with protection class IP54 (option 3350-540) For robots with protection type Clean Room (option 3351-1)</p>  <p>xx2100002434</p> <p>For underneath outlet cable version: For robots with protection class IP30 (option 3350-300)</p>  <p>xx2100001202</p>
4	<p>Secure the base plate/ rear plate to the base with the screws.</p>	

Continues on next page



5 Repair

5.5.1 Replacing the inner arm

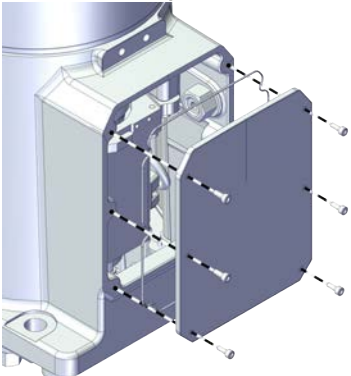

Continued

	Action	Note
		<p>For robots with protection class IP54 (option 3350-540) For robots with protection type Clean Room (option 3351-1)</p>  <p>xx2100002435</p>
5	Refit the robot back to the ground.	
6	Secure with the screws.	<p>Screws: Hex socket head cap screw M12x35 12.9 Gleitmo 603+Geomet 500 (4 pcs) Steel Washers: 24 mm x 13 mm x 2.5 mm (4 pcs) Tightening torque: 56 Nm ±10%</p>

Refitting the outer arm to the inner arm

	Action	Note
1	<p>For robots with protection type Clean Room: Clean the joints that have been opened and wipe the parts free from particles with spirit on a lint free. See Cut the paint or surface on the robot before replacing parts on page 118</p> <p> Note After all repair work, wipe the Clean Room robot free from particles with spirit on a lint free cloth.</p>	
2	<p> CAUTION Whenever parting/mating motor and gearbox, the gears may be damaged if excessive force is used.</p>	

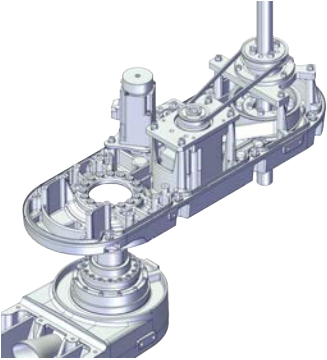
Continues on next page

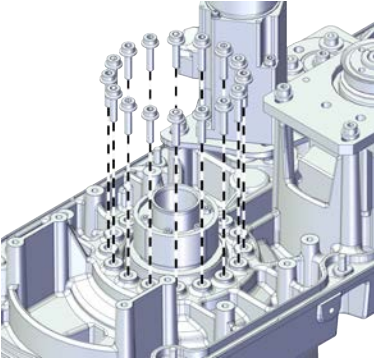
	Action	Note
3	<p>Refit the outer arm to the axis-2 gear unit on the inner arm. (Location pin?)</p> <p> Tip</p> <p>When the gear unit is in the right position, you can hear a clear "Click".</p>	 <p>xx2100001050</p>
4	<p>Refit the screws.</p> <p> Note</p> <p>The two screw holes under the axis-2 belt location are left empty.</p>	<p>Screws: Hex socket head cap screw M4x16 12.9 Lafre 2C2B/FC6.9 (14 pcs)</p> <p>Washers: Spring washer 9x4.3x1 Steel (14 pcs)</p> <p>Tightening torque: 3.5 Nm ±10%</p>  <p>xx2100001049</p>



Refitting the axis-2 motor sub-assembly

	Action	Note
1	<p>For robots with protection type Clean Room:</p> <p>Clean the joints that have been opened and wipe the parts free from particles with spirit on a lint free. See Cut the paint or surface on the robot before replacing parts on page 118</p> <p> Note</p> <p>After all repair work, wipe the Clean Room robot free from particles with spirit on a lint free cloth.</p>	

5 Repair

5.5.1 Replacing the inner arm

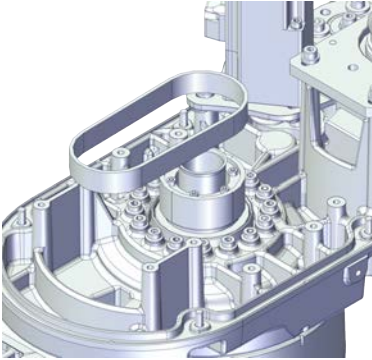
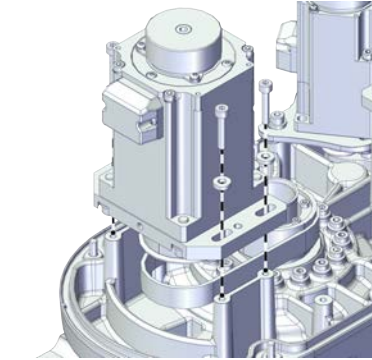
Continued

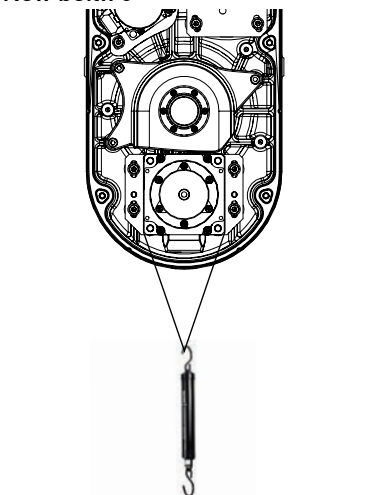
	Action	Note
2	Refit the axis-2 timing belt onto the pulley on the axis-2 gearbox.	 <p>xx2100001048</p>
3	Refit the motor and refit the timing belt to the motor. Ensure that the belt runs correctly in the grooves.	Screws: Hex socket head cap screw M4x20 12.9 Lafre 2C2B/FC6.9 (4 pcs)
4	Refit the screws and washers without fully tightened.	Washers: Plain washer machining 4.2x9x2 steel (4 pcs) Tightening torque: 2.3 Nm \pm 10%  <p>xx2100001046</p> Timing belt A2: 3HAC061861-001
5	Hang a strap to the motor.	
6	Use a handheld dynamometer hooking to the strap and pull the dynamometer to make the tension falling in the allowed force range.  Note During the measurement, make sure that all interferences that may affect the force are removed. Pay attention to the force application direction.  Tip If the ball screw will interfere with the handheld dynamometer, adjust the ball screw manually.	Used belt: 64.7 New belt:70  <p>xx2100001125</p>

Continues on next page

5.5.1 Replacing the inner arm
Continued

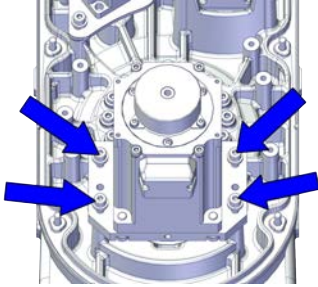
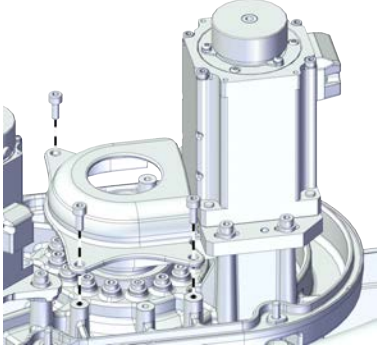
	Action	Note
7	Fasten the screws to the recommended tightening torque.	Tightening torque: 2.3 Nm ±10%  xx2100001176
8	Use a sonic tension meter to measure the timing belt tension.	Used belt: 315 New belt:260
9	If the timing belt tension does not meet the requirement, loosen the motor screws and readjust.	
10	Refit the pulley protection cover and secure with screws.	Screws: Hex socket head cap screw M4x10 12.9 Lafre 2C2B/FC6.9 (3 pcs) Tightening torque: 0.8 Nm  xx2100001047

Inserting the main harness through the axis -2 gearbox position

	Action	Note
1	For robots with protection type Clean Room: Clean the joints that have been opened and wipe the parts free from particles with spirit on a lint free. See Cut the paint or surface on the robot before replacing parts on page 118  Note After all repair work, wipe the Clean Room robot free from particles with spirit on a lint free cloth.	

Continues on next page

5 Repair

5.5.1 Replacing the inner arm



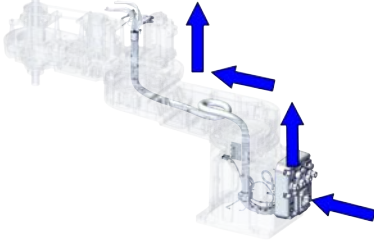
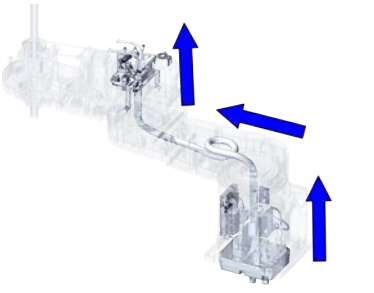



Continued

	Action	Note
2	<p>Insert the internal harness into the outer arm through the plastic protection tube and the centre of the axis-2 gearbox.</p> <p> Tip</p> <p>Wrap the connectors with the masking tape.</p>	<p>For rear outlet cable version:</p>  <p>xx2100000955</p> <p>For underneath outlet cable version:</p>  <p>xx2100001206</p>
3	Secure the R2.MP3 and R2.MP4 with cable straps.	

Refitting the cable ferrule and bracket in the outer arm

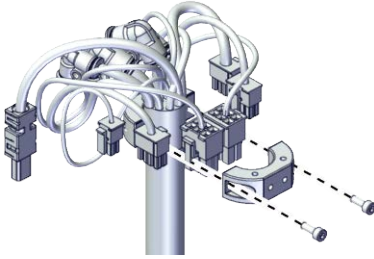
	Action	Note
1	<p>For robots with protection type Clean Room: Clean the joints that have been opened and wipe the parts free from particles with spirit on a lint free. See Cut the paint or surface on the robot before replacing parts on page 118</p> <p> Note</p> <p>After all repair work, wipe the Clean Room robot free from particles with spirit on a lint free cloth.</p>	
2	Lay the internal harness in a natural state without distortion.	

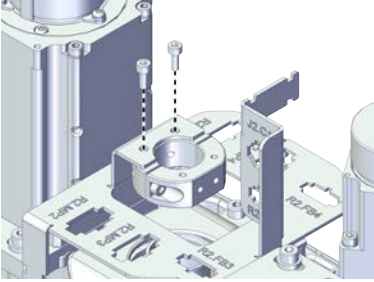
Continues on next page







	Action	Note
3	<p>Refit the cable ferrule and secure it with the screws.</p> <p> Tip</p> <p>The air hoses should face the process hub side.</p> <p> Tip</p> <p>The position with wrapped tape is the marked position for the cable ferrule.</p> <p> Tip</p> <p>Align all the cable ferrules so that the cable is in a natural bending position to avoid twisting.</p>	<p>Screws: Hex socket head cap screw M3x8 12.9 Lafre 2C2B/FC6.9 (2 pcs)</p> <p>Tightening torque: 1.2 Nm ±10%</p>  <p>xx1800002849</p>
4	<p>Secure the cable ferrule to the bracket.</p> <p> Tip</p> <p>Align all the cable ferrules so that the cable is in a natural bending position to avoid twisting.</p> <p> Note</p> <p>The harness are not visible due to the cleanness requirements of the illustration. They are still existing inside the cable ferrule in the actual situation.</p>	<p>Screws: Hex socket head cap screw M3x8 12.9 Lafre 2C2B/FC6.9 (2 pcs)</p> <p>Tightening torque: 1.2 Nm ±10%</p>  <p>xx2100000940</p>
5	<p>Refit the bracket without securing.</p> <p> Tip</p> <p>Do not secure it with the screws before the cable ferrule installed well.</p> <p> Note</p> <p>The harness are not visible due to the cleanness requirements of the illustration. They are still existing inside the cable ferrule in the actual situation.</p>	

5 Repair

5.5.1 Replacing the inner arm

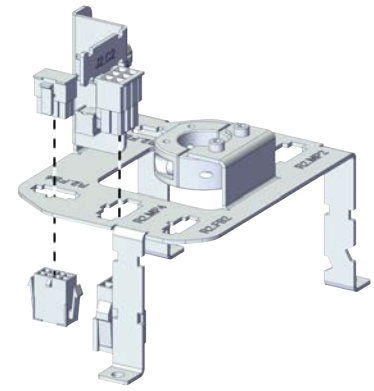

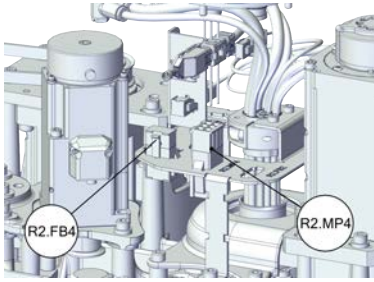



Continued

Reconnecting the connectors for axis-4 motor

	Action	Note
1	<p>For robots with protection type Clean Room: Clean the joints that have been opened and wipe the parts free from particles with spirit on a lint free. See Cut the paint or surface on the robot before replacing parts on page 118</p> <p> Note</p> <p>After all repair work, wipe the Clean Room robot free from particles with spirit on a lint free cloth.</p>	
	<p>Insert the female head of the connectors to the bracket accordingly.</p> <p> Tip</p> <p>The mistake proofing measure has been applied to the connectors, the connectors may be damaged if excessive force is used.</p> <p> Note</p> <p>The harness are not visible due to the cleanness requirements of the illustration. They are still existing inside the cable ferrule in the actual situation.</p>	 <p>xx210000939</p>
2	<p>Reconnect the connectors.</p> <ul style="list-style-type: none"> • R2.MP4 • R2.FB4 <p> Tip</p> <p>See the number markings on the connectors for help to find the corresponding connector.</p>	 <p>xx210000938</p>
3	<p>Route the cabling on the axis-4 motor.</p> <p> CAUTION</p> <p>Correct cable routing is highly important. If the cables are routed and secured incorrectly the cables can be damaged.</p>	

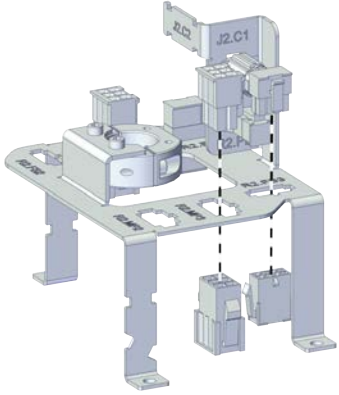
Continues on next page

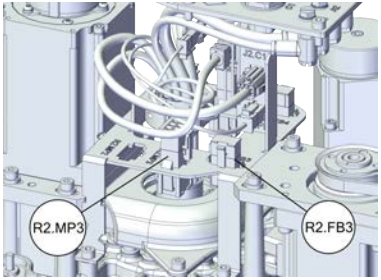
Reconnecting the connectors for axis-3 motor

	Action	Note
1	<p>For robots with protection type Clean Room: Clean the joints that have been opened and wipe the parts free from particles with spirit on a lint free. See Cut the paint or surface on the robot before replacing parts on page 118</p> <p> Note</p> <p>After all repair work, wipe the Clean Room robot free from particles with spirit on a lint free cloth.</p>	
2	<p>Insert the female head of the connectors to the bracket accordingly.</p> <p> Tip</p> <p>The mistake proofing measure has been applied to the connectors, the connectors may be damaged if excessive force is used.</p> <p> Note</p> <p>The harness are not visible due to the cleanness requirements of the illustration. They are still existing inside the cable ferrule in the actual situation.</p>	 <p>xx2100000937</p>
3	<p>Reconnect the connectors.</p> <ul style="list-style-type: none"> • R2.MP3 • R2.FB3 <p> Tip</p> <p>See the number markings on the connectors for help to find the corresponding connector.</p>	 <p>xx2100000936</p>
4	<p>Route the cabling on the axis-3 motor.</p> <p> CAUTION</p> <p>Correct cable routing is highly important. If the cables are routed and secured incorrectly the cables can be damaged.</p>	







Continues on next page

5 Repair

5.5.1 Replacing the inner arm

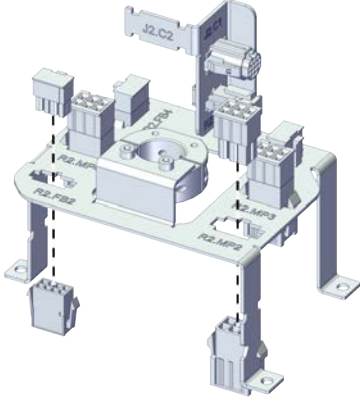

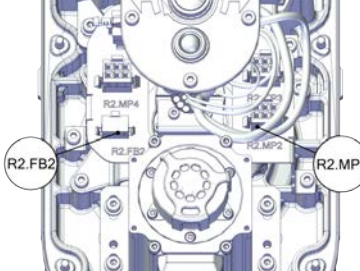



Continued

Reconnecting the connectors for axis-2 motor

	Action	Note
1	<p>For robots with protection type Clean Room: Clean the joints that have been opened and wipe the parts free from particles with spirit on a lint free. See Cut the paint or surface on the robot before replacing parts on page 118</p> <p> Note</p> <p>After all repair work, wipe the Clean Room robot free from particles with spirit on a lint free cloth.</p>	
2	<p>Insert the female head of the connectors to the bracket accordingly.</p> <p> Tip</p> <p>The mistake proofing measure has been applied to the connectors, the connectors may be damaged if excessive force is used.</p> <p> Note</p> <p>The harness are not visible due to the cleanness requirements of the illustration. They are still existing inside the cable ferrule in the actual situation.</p>	 <p>xx2100000935</p>
3	<p>Reconnect the connectors.</p> <ul style="list-style-type: none"> • R2.MP2 • R2.FB2 <p> Tip</p> <p>See the number markings on the connectors for help to find the corresponding connector.</p>	 <p>xx2100000934</p>
4	<p>Route the cabling behind the axis-2 motor.</p> <p> CAUTION</p> <p>Correct cable routing is highly important. If the cables are routed and secured incorrectly the cables can be damaged.</p>	

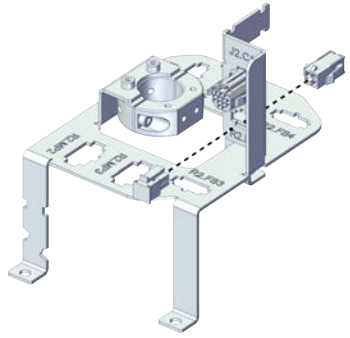
Continues on next page

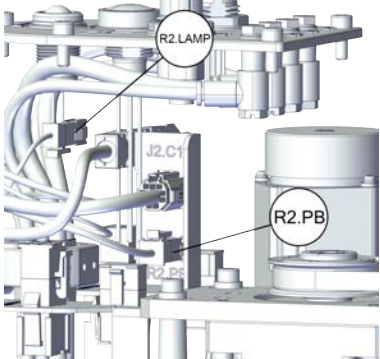
Reconnecting the connector for PB

	Action	Note
1	<p>For robots with protection type Clean Room: Clean the joints that have been opened and wipe the parts free from particles with spirit on a lint free. See Cut the paint or surface on the robot before replacing parts on page 118</p> <p> Note</p> <p>After all repair work, wipe the Clean Room robot free from particles with spirit on a lint free cloth.</p>	
2	<p>Insert the female head of the PB connector to the bracket accordingly.</p> <p> Tip</p> <p>The mistake proofing measure has been applied to the connectors, the connectors may be damaged if excessive force is used.</p> <p> Note</p> <p>The harness are not visible due to the cleanness requirements of the illustration. They are still existing inside the cable ferrule in the actual situation.</p>	 <p>xx2100001031</p>
3	<p>Reconnect the connector.</p> <ul style="list-style-type: none"> • R2.PB • R2.LAMP <p> Tip</p> <p>See the number markings on the connectors for help to find the corresponding connector.</p>	 <p>xx2100001030</p>
4	<p>Route and secure the cabling with cable straps if needed.</p> <p> CAUTION</p> <p>Correct cable routing is highly important. If the cables are routed incorrectly the cables can be damaged.</p>	



Continues on next page

5 Repair







5.5.1 Replacing the inner arm

Continued

Reconnecting the air hoses, CP/CS cabling and Ethernet cabling (if equipped)

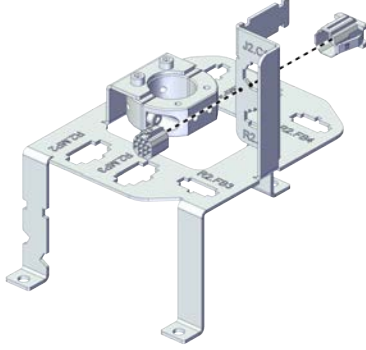
	Action	Note
1	<p>For robots with protection type Clean Room: Clean the joints that have been opened and wipe the parts free from particles with spirit on a lint free. See Cut the paint or surface on the robot before replacing parts on page 118</p> <p> Note</p> <p>After all repair work, wipe the Clean Room robot free from particles with spirit on a lint free cloth.</p>	
2	<p>Route the air hoses on the process hub behind the bracket.</p> <p> CAUTION</p> <p>Correct cable routing is highly important. If the cables are routed and secured incorrectly the cables can be damaged.</p>	

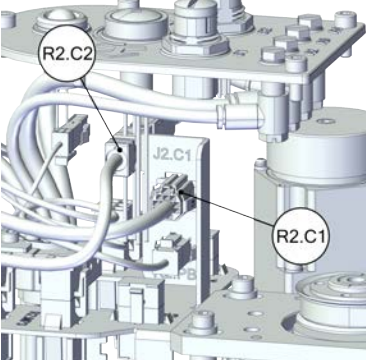
Continues on next page

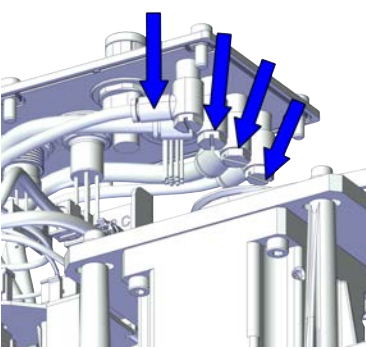
	Action	Note
3	<p>Insert the female head of the C1 cabling connector to the bracket accordingly.</p> <p> Tip</p> <p>The mistake proofing measure has been applied to the connectors, the connectors may be damaged if excessive force is used.</p> <p> Note</p> <p>The harness are not visible due to the cleanness requirements of the illustration. They are still existing inside the cable ferrule in the actual situation.</p>	 <p>xx2100001034</p>
4	<p>For robots with C1 cabling</p> <p>Reconnect the connector.</p> <ul style="list-style-type: none"> • R2.C1 <p> Tip</p> <p>See the number markings on the air hoses for help to find the corresponding air hoses.</p> <p>The air hoses with the same number connect to the same L-shaped connector.</p>	 <p>xx2100001033</p>
5	<p>For robots with C2 cabling</p> <p>Reconnect the connector.</p> <ul style="list-style-type: none"> • R1.C2 <p> Tip</p> <p>See the number markings on the air hoses for help to find the corresponding air hoses.</p> <p>The air hoses with the same number connect to the same L-shaped connector.</p>	
6	<p>Secure the C2 cabling to the C2 bracket with the cable straps.</p>	
7	<p>Reconnect the air hoses in a cross pattern with the L-shaped connectors.</p> <p> Tip</p> <p>See the number markings on the air hoses for help to find the corresponding air hoses.</p> <p>The air hoses with the same number connect to the same Y-shaped connector.</p>	 <p>xx2100001032</p>

Continues on next page



5 Repair

5.5.1 Replacing the inner arm

Continued

	Action	Note
8	<p>Route and secure the cabling with cable straps if needed.</p> <p> CAUTION</p> <p>Correct cable routing is highly important. If the cables are routed and secured incorrectly the cables can be damaged.</p>	

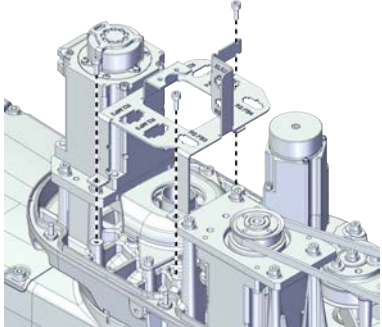

Securing the bracket in the outer arm

	Action	Note
1	<p>For robots with protection type Clean Room: Clean the joints that have been opened and wipe the parts free from particles with spirit on a lint free. See Cut the paint or surface on the robot before replacing parts on page 118</p> <p> Note</p> <p>After all repair work, wipe the Clean Room robot free from particles with spirit on a lint free cloth.</p>	
2	<p>Refit the bracket.</p> <p> Tip</p> <p>Do not secure it with the screws before the cable ferrule installed well.</p> <p> Note</p> <p>The harness are not visible due to the cleanness requirements of the illustration. They are still existing inside the cable ferrule in the actual situation.</p>	<p>Screws: Hex socket head cap screw M4x10 12.9 Lafre 2C2B/FC6.9 (3 pcs)</p> <p>Tightening torque: 1.2 Nm \pm10%</p>  <p>xx2100000941</p>

Refitting the cover of the outer arm

	Action	Note
1	<p>For robots with protection type Clean Room: Clean the joints that have been opened and wipe the parts free from particles with spirit on a lint free. See Cut the paint or surface on the robot before replacing parts on page 118</p> <p> Note</p> <p>After all repair work, wipe the Clean Room robot free from particles with spirit on a lint free cloth.</p>	

Continues on next page

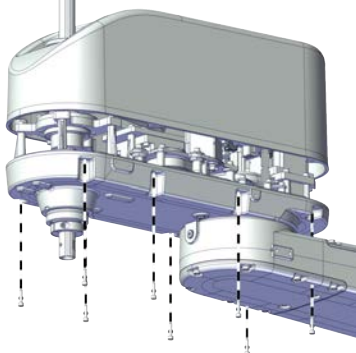
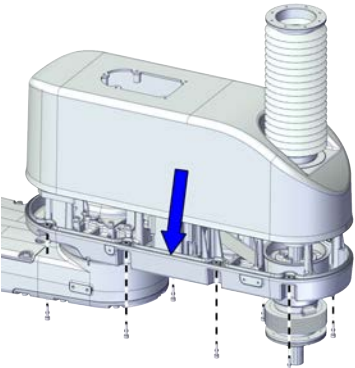
	Action	Note
2	<p>Refit the cover.</p> <p> Note</p> <p>For robots with protection class IP54 (option 3350-540)</p> <p>For robots with protection type Clean Room (option 3351-1)</p> <p>Refit the cover with bellow.</p> <p>Check the gasket for the outer arm cover.</p> <p> Tip</p> <p>Replace the gasket if needed.</p> <p> CAUTION</p> <p>The gasket is in the outer arm.</p>	<p>Screw: Hex socket head cap screw M4x16 12.9 Lafre 2C2B/FC6.9 (8 pcs)</p> <p>Tightening torque: 2 Nm ±10%</p> <p>For robots with protection class IP30 (option 3350-300)</p>  <p>xx210000933</p>
3	<p>Refit the screws.</p>	<p>For robots with protection class IP54 (option 3350-540)</p> <p>For robots with protection type Clean Room (option 3351-1)</p>  <p>xx2100002427</p>

For Clean Room/ IP54 robots

Refitting the top cover and the flange with bearing



	Action	Note
1	<p>For robots with protection type Clean Room:</p> <p>Clean the joints that have been opened and wipe the parts free from particles with spirit on a lint free. See Cut the paint or surface on the robot before replacing parts on page 118</p> <p> Note</p> <p>After all repair work, wipe the Clean Room robot free from particles with spirit on a lint free cloth.</p>	

Continues on next page

5 Repair

5.5.1 Replacing the inner arm

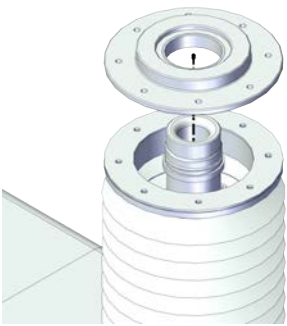
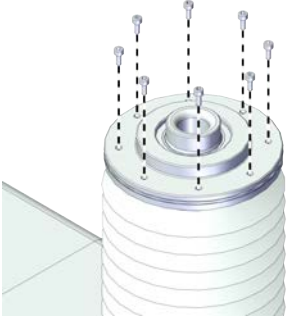
Continued

	Action	Note
2	<p>For robots with protection class IP54 (option 3350-540)</p> <p>For robots with protection type Clean Room (option 3351-1)</p> <p>Install the flange with bearing to the extension shaft.</p>	 <p>xx2100002402</p>
3	<p>For robots with protection class IP54 (option 3350-540)</p> <p>For robots with protection type Clean Room (option 3351-1)</p> <p>Refit the screws to the flange with bearing.</p>	<p>Screws: Hex socket head cap screw M2.5x6 12.9 Lafre 2C2B/FC6.9 (8 pcs)</p> <p>Tightening torque: 0.8 Nm \pm10%</p>  <p>xx2100002401</p>
4	<p>For robots with protection class IP54 (option 3350-540)</p> <p>For robots with protection type Clean Room (option 3351-1)</p> <p>Refit the top cover to the ball screw.</p> <p> Tip</p> <p>The top surface of the cover should be flush with the top end of the ball screw.</p>	 <p>xx2100002399</p>

Continues on next page

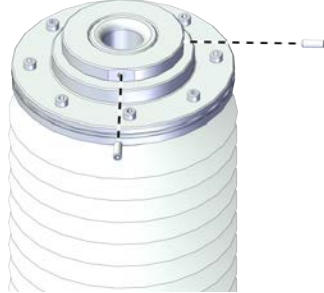
	Action	Note
5	<p>For robots with protection class IP54 (option 3350-540)</p> <p>For robots with protection type Clean Room (option 3351-1)</p> <p>Refit the locking screws.</p>	<p>Screws: Hexagon socket set screws with flat point, ISO 4026 stainless steel M3x8 (2 pcs)</p> <p>Tightening torque: 0.4 Nm \pm10%</p>  <p>xx2100002398</p>



Securing the process hub to outer arm cover

	Action	Note
1	<p>For robots with protection type Clean Room:</p> <p>Clean the joints that have been opened and wipe the parts free from particles with spirit on a lint free. See Cut the paint or surface on the robot before replacing parts on page 118</p> <p> Note</p> <p>After all repair work, wipe the Clean Room robot free from particles with spirit on a lint free cloth.</p>	
2	Insert the process hub from the outer arm cover.	

5 Repair

5.5.1 Replacing the inner arm

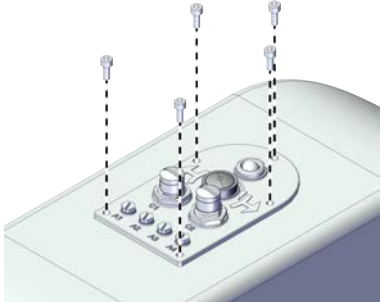
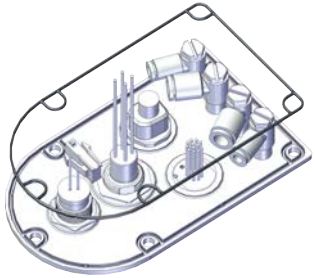

Continued

	Action	Note
3	<p>Secure the process hub to the outer arm cover with the screws.</p> <p> Note</p> <p>For robots with protection class IP54 (option 3350-540)</p> <p>For robots with protection type Clean Room (option 3351-1)</p> <p>Check the gasket for the process hub.</p> <p> Tip</p> <p>Replace the gasket if needed.</p> <p> CAUTION</p> <p>Be aware of the cabling that is attached to the cover! The cover can not be removed completely until the connectors are disconnected, as shown in following steps.</p>	<p>Screws: Hex socket head cap screw M4x10 12.9 Lafre 2C2B/FC6.9 (5 pcs)</p> <p>Tightening torque: 2.6 Nm±10%</p> <p>For robots with protection class IP30 (option 3350-300)</p>  <p>xx2100000932</p> <p>For robots with protection class IP54 (option 3350-540)</p> <p>For robots with protection type Clean Room (option 3351-1)</p>  <p>xx2100002438</p>

Refitting the axis-1 cover

	Action	Note
1	<p>For robots with protection type Clean Room:</p> <p>Clean the joints that have been opened and wipe the parts free from particles with spirit on a lint free. See Cut the paint or surface on the robot before replacing parts on page 118</p> <p> Note</p> <p>After all repair work, wipe the Clean Room robot free from particles with spirit on a lint free cloth.</p>	

Continues on next page

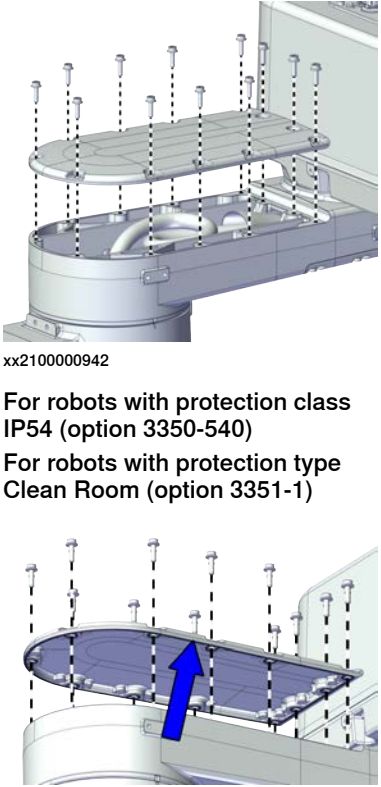
	Action	Note
2	<p>Refit the cover.</p> <p> Note</p> <p>For robots with protection class IP54 (option 3350-540)</p> <p>For robots with protection type Clean Room (option 3351-1)</p> <p>Check the gasket for the cover before refitting the cover.</p> <p> Tip</p> <p>Replace the gasket if needed.</p>	<p>For IRB 920T-6/0.45 : Screw: Hex socket head cap flange screw M5x16 12.9 Lafre 2C2B/FC6.9+PrO-COat111 (10 pcs)</p> <p>For IRB 920T-6/0.55 : Screw: Hex socket head cap flange screw M5x16 12.9 Lafre 2C2B/FC6.9+PrO-COat111 (12 pcs)</p> <p>For IRB 920T-6/0.65 : Screw: Hex socket head cap flange screw M5x16 12.9 Lafre 2C2B/FC6.9+PrO-COat111 (16 pcs)</p> <p>Tightening torque: 5.4 Nm ±3%</p> <p>For robots with protection class IP30 (option 3350-300)</p>
3	<p>Refit the screws.</p>	 <p>xx2100000942</p> <p>For robots with protection class IP54 (option 3350-540)</p> <p>For robots with protection type Clean Room (option 3351-1)</p> <p>xx2100002428</p>

Refitting the axis-2 cover



	Action	Note
1	<p> DANGER</p> <p>Make sure that all supplies for electrical power, hydraulic pressure, and air pressure are turned off.</p>	

Continues on next page

5 Repair

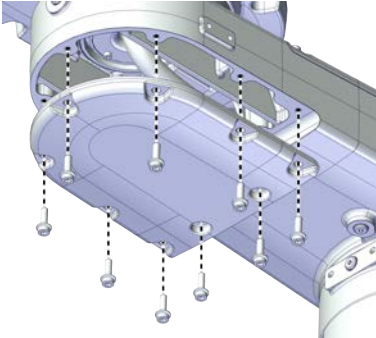
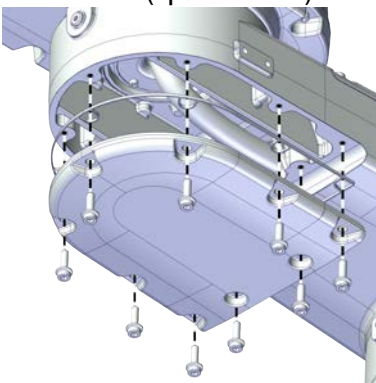

5.5.1 Replacing the inner arm

Continued

	Action	Note
2	<p> CAUTION</p> <p>For robots with protection type Clean Room Always cut the paint with a knife and grind the paint edge when disassembling parts of the robot! See Cut the paint or surface on the robot before replacing parts on page 118.</p>	
3	<p>Refit the cover.</p> <p> Note</p> <p>For robots with protection class IP54 (option 3350-540) For robots with protection type Clean Room (option 3351-1) Check the gasket for the cover before refitting the cover.</p> <p> Tip</p> <p>Replace the gasket if needed.</p>	<p>Screws: Hex socket head cap flange screw M5x16 12.9 Lafre 2C2B/FC6.9+PrO-COat111 (9 pcs) Tightening torque: 1.2 Nm \pm10%</p> <p>For robots with protection class IP30 (option 3350-300)</p>  <p>xx210000943</p>
4	<p>Refit the screws.</p>	<p>For robots with protection class IP54 (option 3350-540) For robots with protection type Clean Room (option 3351-1)</p>  <p>xx2100002451</p>

Continues on next page

Concluding procedure

	Action	Note
1	<p>For robots with protection type Clean Room: Seal and paint the joints that have been opened. See Cut the paint or surface on the robot before replacing parts on page 118</p> <p> Note</p> <p>After all repair work, wipe the Clean Room robot free from particles with spirit on a lint free cloth.</p>	
2	Recalibrate the robot.	Calibration is detailed in section Calibration on page 945 .
3	<p> DANGER</p> <p>Make sure all safety requirements are met when performing the first test run.</p>	

5 Repair

5.6.1 Replacing the mechanical stopper

5.6 Outer arm

5.6.1 Replacing the mechanical stopper

Location of the mechanical stoppers

The mechanical stoppers are located as shown in the figure.

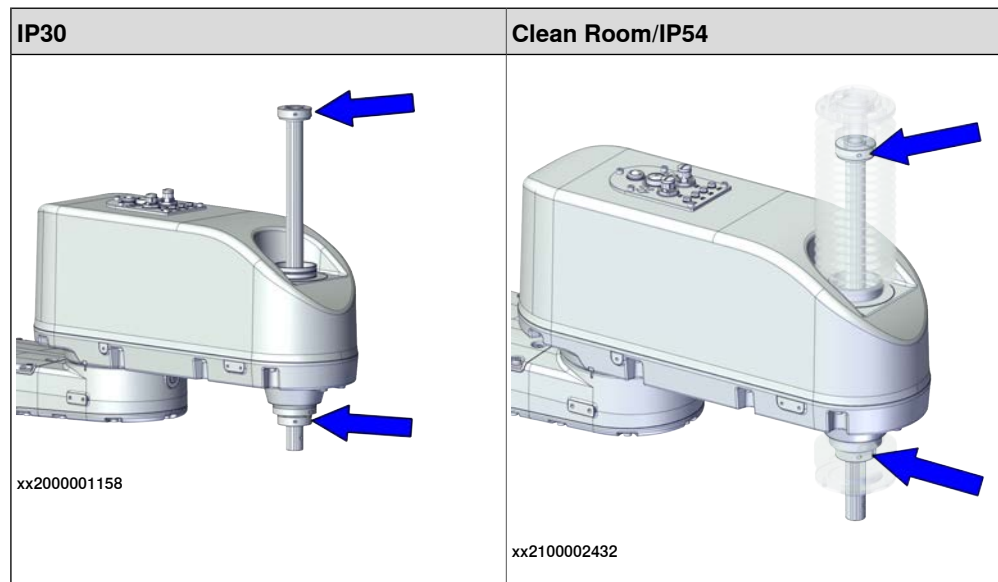

CAUTION

For the robots with protection type Clean Room and protection class IP54, the mechanical stops are inside the bellows. If needed, remove the bellows to inspect the ball screw spline unit.

For the details on removing the bellows, refer to [Replacing the bellows](#).

Required spare parts



Note

The spare part numbers that are listed in the table can be out of date. See the latest spare parts of the IRB 920 via myABB Business Portal, www.abb.com/myABB.

Spare part	Article number	Note
Mechanical-Stop top, D20	3HAC073068-001	With bolt
Mechanical-Stop bottom, D20	3HAC073069-001	With bolt

Required tools and equipment

Equipment	Article number	Note
Standard toolkit	-	Content is defined in section Standard toolkit on page 996 .

Continues on next page

Equipment	Article number	Note
Calibration toolbox, Axis Calibration	3HAC055412-001	Delivered as a set of calibration tools. Required if Axis Calibration is the valid calibration method for the robot.
24 VDC power supply	-	Used to release the motor brakes.

Required consumables

Consumable	Article number	Note
Cable straps	-	
Grease	-	THK AFA

Deciding calibration routine

Decide which calibration routine to be used, based on the information in the table. Depending on which routine is chosen, action might be required prior to beginning the repair work of the robot, see the table.

	Action	Note
1	Decide which calibration routine to use for calibrating the robot. <ul style="list-style-type: none"> Reference calibration. External cable packages (DressPack) and tools can stay fitted on the robot. Fine calibration. All external cable packages (DressPack) and tools must be removed from the robot. 	
	<p>If the robot is to be calibrated with reference calibration:</p> <p>Find previous reference values for the axis or create new reference values. These values are to be used after the repair procedure is completed, for calibration of the robot.</p> <p>If no previous reference values exist, and no new reference values can be created, then reference calibration is not possible.</p>	<p>Follow the instructions given in the reference calibration routine on the FlexPendant to create reference values.</p> <p>Creating new values requires possibility to move the robot.</p> <p>Read more about reference calibration for Axis Calibration in Reference calibration routine on page 957.</p>
	<p>If the robot is to be calibrated with fine calibration:</p> <p>Remove all external cable packages (DressPack) and tools from the robot.</p>	

Removing the upper mechanical stopper

Use these procedures to remove the upper mechanical stopper.

Preparations before removing the upper mechanical stopper



	Action	Note
1	Decide which calibration routine to use, and take actions accordingly prior to beginning the repair procedure.	

Continues on next page



5 Repair

5.6.1 Replacing the mechanical stopper

Continued

	Action	Note
2	 DANGER Turn off all: <ul style="list-style-type: none"> • electric power supply • hydraulic pressure supply • air pressure supply to the robot, before entering the safeguarded space.	
3	 CAUTION For robots with protection type Clean Room Always cut the paint with a knife and grind the paint edge when disassembling parts of the robot! See Cut the paint or surface on the robot before replacing parts on page 118 .	

Removing the top cover and the flange with bearing

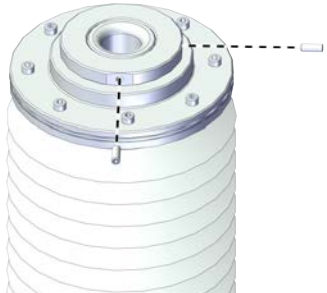
	Action	Note
1	 DANGER Make sure that all supplies for electrical power, hydraulic pressure, and air pressure are turned off.	
2	 CAUTION For robots with protection type Clean Room Always cut the paint with a knife and grind the paint edge when disassembling parts of the robot! See Cut the paint or surface on the robot before replacing parts on page 118 .	
3	For robots with protection class IP54 (option 3350-540) For robots with protection type Clean Room (option 3351-1) Loose the locking screws.	 xx2100002398

Continues on next page

5.6.1 Replacing the mechanical stopper
Continued

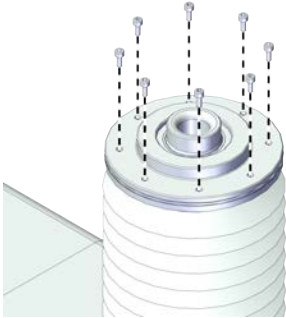
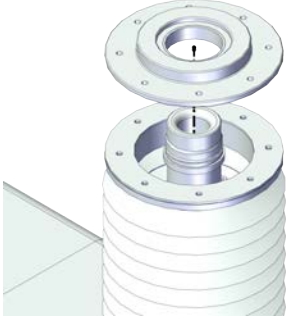
	Action	Note
4	<p>For robots with protection class IP54 (option 3350-540) For robots with protection type Clean Room (option 3351-1) Remove the top cover from the ball screw.</p>	 <p>xx2100002399</p>
5	<p>For robots with protection class IP54 (option 3350-540) For robots with protection type Clean Room (option 3351-1) Remove the screws on the flange with bearing.</p>	 <p>xx2100002401</p>
6	<p>For robots with protection class IP54 (option 3350-540) For robots with protection type Clean Room (option 3351-1) Remove the flange with bearing.</p>	 <p>xx2100002402</p>

Removing the extension shaft for Clean Room/ IP54 robots





	Action	Note
1	 <p>DANGER</p> <p>Make sure that all supplies for electrical power, hydraulic pressure, and air pressure are turned off.</p>	

Continues on next page

5 Repair

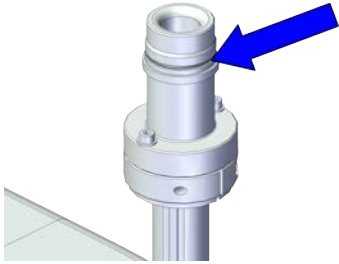

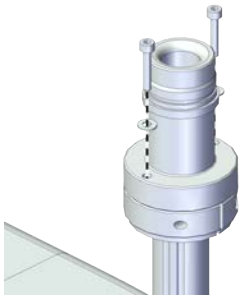

5.6.1 Replacing the mechanical stopper

Continued

	Action	Note
2	<p> CAUTION</p> <p>For robots with protection type Clean Room Always cut the paint with a knife and grind the paint edge when disassembling parts of the robot! See Cut the paint or surface on the robot before replacing parts on page 118.</p>	
3	<p>For robots with protection class IP54 (option 3350-540) For robots with protection type Clean Room (option 3351-1) Remove the O-ring from the upper housing.</p>	 <p>xx2100002419</p>
4	<p>For robots with protection class IP54 (option 3350-540) For robots with protection type Clean Room (option 3351-1) Loose the attachment screws.</p> <p> Note</p> <p>For robots with protection class IP54 (option 3350-540) Clean the upper housing from the glue if it will be reused.</p>	 <p>xx2100002420</p>
5	<p>For robots with protection class IP54 (option 3350-540) For robots with protection type Clean Room (option 3351-1) Remove the extension shaft from the mechanical stopper.</p> <p> Note</p> <p>For robots with protection class IP54 (option 3350-540) Check the gasket for the extension shaft and replace it if needed.</p>	 <p>xx2100002421</p>

Continues on next page

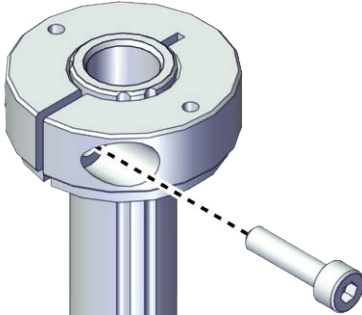
Removing the upper mechanical stopper

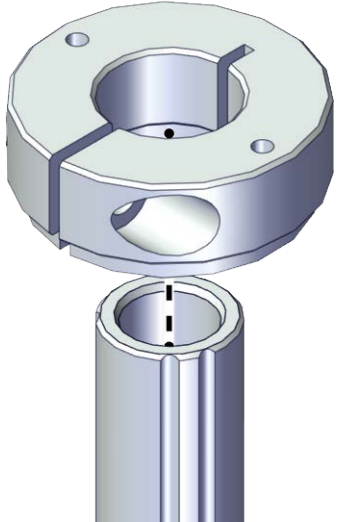
	Action	Note
1	 DANGER Make sure that all supplies for electrical power, hydraulic pressure, and air pressure are turned off.	
2	 CAUTION For robots with protection type Clean Room Always cut the paint with a knife and grind the paint edge when disassembling parts of the robot! See <i>Cut the paint or surface on the robot before replacing parts on page 118.</i>	
3	Remove the screw.	 <p>xx1800002858</p>
4	Remove the mechanical stopper.  Tip Hold the ball screw to prevent it from dropping. Or the ball screw may be destroyed.  CAUTION If the ball screw nut or ball screw spline nut go out of the screw shaft, the ball screw is destroyed. Be careful when you do any work that may cause this.	 <p>xx1800002859</p>

Continues on next page

5 Repair

5.6.1 Replacing the mechanical stopper

Continued

Refitting the upper mechanical stopper



Use these procedures to refit the upper mechanical stopper.

Refitting the upper mechanical stopper

	Action	Note
1	<p>For robots with protection type Clean Room: Clean the joints that have been opened and wipe the parts free from particles with spirit on a lint free. See Cut the paint or surface on the robot before replacing parts on page 118</p> <p> Note</p> <p>After all repair work, wipe the Clean Room robot free from particles with spirit on a lint free cloth.</p>	

Continues on next page

5.6.1 Replacing the mechanical stopper
Continued

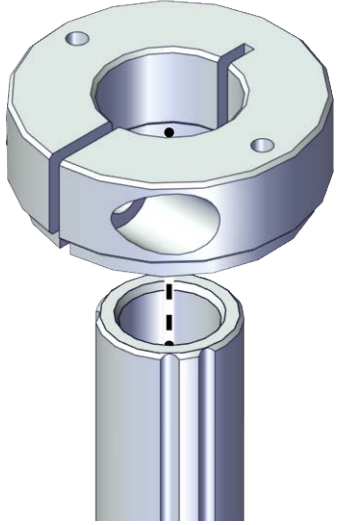
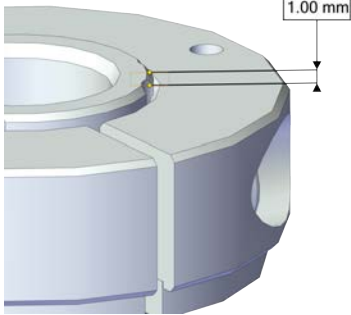
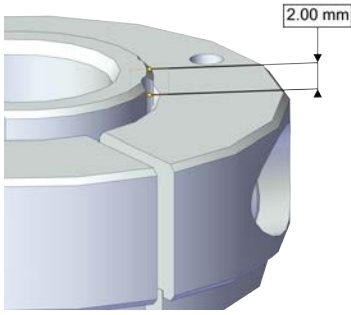
	Action	Note
2	<p>Refit the mechanical stopper to the ball screw at 1 mm position to the upper of the ball screw.</p> <p> Note</p> <p>For robots with protection class IP54 (option 3350-540) For robots with protection type Clean Room (option 3351-1) Refit the mechanical stopper to the ball screw at 2 mm position to the upper of the ball screw.</p> <p> Tip</p> <p>Hold the ball screw to prevent it from dropping. Or the ball screw may be destroyed.</p> <p> CAUTION</p> <p>If the ball screw nut or ball screw spline nut go out of the screw shaft, the ball screw is destroyed. Be careful when you do any work that may cause this.</p>	 <p>xx1800002859</p> <p>For robots with protection class IP30 (option 3350-300)</p>  <p>xx1900002012</p> <p>For robots with protection class IP54 (option 3350-540) For robots with protection type Clean Room (option 3351-1)</p>  <p>xx1900002011</p>

Continues on next page



5 Repair

5.6.1 Replacing the mechanical stopper

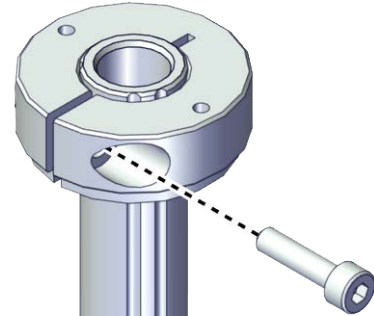
Continued



	Action	Note
3	Refit the screw.	<p>Screws: Hex socket head cap screw M4x16 12.9 Lafre 2C2B/FC6.9 (1 pcs) Tightening torque: 6.5 Nm</p>  <p>xx1800002858</p>

Refitting the extension shaft for Clean Room/ IP54 robots

	Action	Note
1	<p>For robots with protection type Clean Room: Clean the joints that have been opened and wipe the parts free from particles with spirit on a lint free. See Cut the paint or surface on the robot before replacing parts on page 118</p> <p> Note</p> <p>After all repair work, wipe the Clean Room robot free from particles with spirit on a lint free cloth.</p>	
2	<p>For robots with protection class IP54 (option 3350-540) For robots with protection type Clean Room (option 3351-1) Install the extension shaft to the ball screw on the upper side of the mechanical stopper.</p> <p> Note</p> <p>For robots with protection class IP54 (option 3350-540) Check the gasket for the extension shaft and replace it if needed.</p>	 <p>xx2100002421</p>

Continues on next page

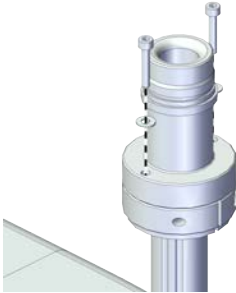
5.6.1 Replacing the mechanical stopper Continued

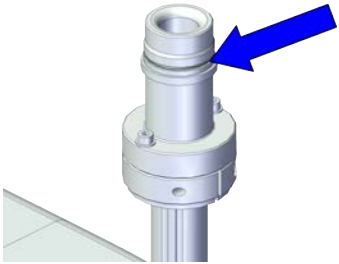
	Action	Note
3	<p>For robots with protection class IP54 (option 3350-540)</p> <p>For robots with protection type Clean Room (option 3351-1)</p> <p>Secure the extension shaft to the mechanical stopper with the screws.</p>	<p>Screws: Hex socket head cap screw M3x16 12.9 Lafre 2C2B/FC6.9 (2 pcs)</p> <p>Tightening torque: 1.2 Nm \pm10%</p>  <p>xx2100002420</p>
4	<p>For robots with protection class IP54 (option 3350-540)</p> <p>For robots with protection type Clean Room (option 3351-1)</p> <p>Insert the O-ring to the extension shaft.</p> <p> Note</p> <p>Replace the o-ring if needed.</p>	 <p>xx2100002419</p>

Refitting the top cover and the flange with bearing



	Action	Note
1	<p>For robots with protection type Clean Room:</p> <p>Clean the joints that have been opened and wipe the parts free from particles with spirit on a lint free. See Cut the paint or surface on the robot before replacing parts on page 118</p> <p> Note</p> <p>After all repair work, wipe the Clean Room robot free from particles with spirit on a lint free cloth.</p>	

Continues on next page

5 Repair

5.6.1 Replacing the mechanical stopper

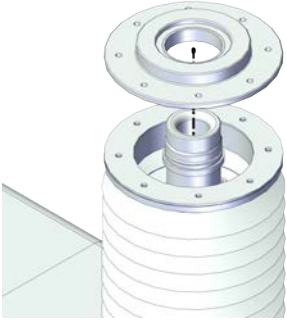
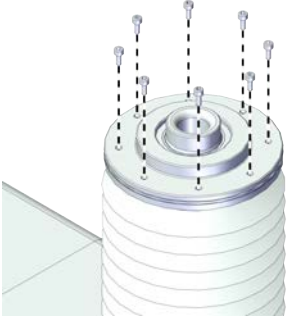
Continued



	Action	Note
2	<p>For robots with protection class IP54 (option 3350-540)</p> <p>For robots with protection type Clean Room (option 3351-1)</p> <p>Install the flange with bearing to the extension shaft.</p>	 <p>xx2100002402</p>
3	<p>For robots with protection class IP54 (option 3350-540)</p> <p>For robots with protection type Clean Room (option 3351-1)</p> <p>Refit the screws to the flange with bearing.</p>	<p>Screws: Hex socket head cap screw M2.5x6 12.9 Lafre 2C2B/FC6.9 (8 pcs)</p> <p>Tightening torque: 0.8 Nm \pm10%</p>  <p>xx2100002401</p>
4	<p>For robots with protection class IP54 (option 3350-540)</p> <p>For robots with protection type Clean Room (option 3351-1)</p> <p>Refit the top cover to the ball screw.</p> <p> Tip</p> <p>The top surface of the cover should be flush with the top end of the ball screw.</p>	 <p>xx2100002399</p>

Continues on next page

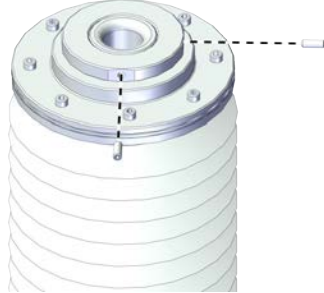
5.6.1 Replacing the mechanical stopper
Continued

	Action	Note
5	<p>For robots with protection class IP54 (option 3350-540)</p> <p>For robots with protection type Clean Room (option 3351-1)</p> <p>Refit the locking screws.</p>	<p>Screws: Hexagon socket set screws with flat point, ISO 4026 stainless steel M3x8 (2 pcs)</p> <p>Tightening torque: 0.4 Nm \pm10%</p>  <p>xx2100002398</p>

Concluding procedure

	Action	Note
1	<p>For robots with protection type Clean Room: Seal and paint the joints that have been opened. See Cut the paint or surface on the robot before replacing parts on page 118</p> <p> Note</p> <p>After all repair work, wipe the Clean Room robot free from particles with spirit on a lint free cloth.</p>	
2	<p> DANGER</p> <p>Make sure all safety requirements are met when performing the first test run.</p>	

Removing the lower mechanical stopper

Use these procedures to remove the lower mechanical stopper.

Preparations before removing the lower mechanical stopper



	Action	Note
1	Decide which calibration routine to use, and take actions accordingly prior to beginning the repair procedure.	
2	Move the ball screw to lower position.	

Continues on next page



5 Repair

5.6.1 Replacing the mechanical stopper

Continued

	Action	Note
3	 DANGER Turn off all: <ul style="list-style-type: none"> • electric power supply • hydraulic pressure supply • air pressure supply to the robot, before entering the safeguarded space.	
4	 CAUTION For robots with protection type Clean Room Always cut the paint with a knife and grind the paint edge when disassembling parts of the robot! See Cut the paint or surface on the robot before replacing parts on page 118 .	

Removing the lower cover and the flange with bearing

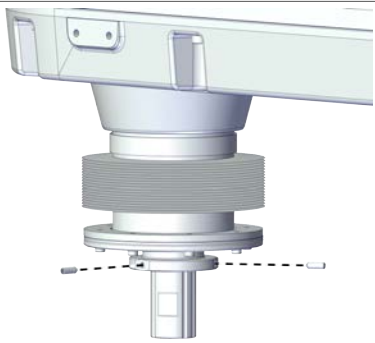
	Action	Note
1	 DANGER Make sure that all supplies for electrical power, hydraulic pressure, and air pressure are turned off.	
2	 CAUTION For robots with protection type Clean Room Always cut the paint with a knife and grind the paint edge when disassembling parts of the robot! See Cut the paint or surface on the robot before replacing parts on page 118 .	
3	For robots with protection class IP54 (option 3350-540) For robots with protection type Clean Room (option 3351-1) Loose the locking screws.	 xx2100002404

Continues on next page

5.6.1 Replacing the mechanical stopper
Continued

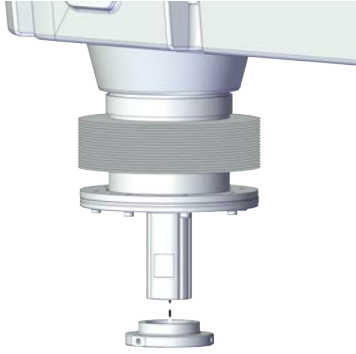
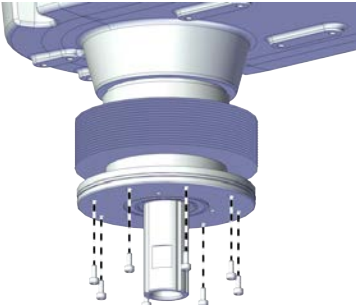
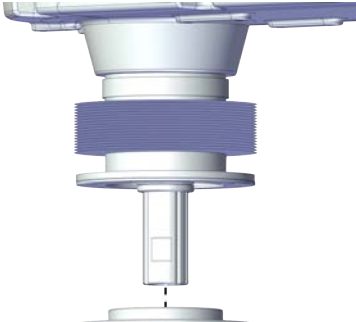
	Action	Note
4	For robots with protection class IP54 (option 3350-540) For robots with protection type Clean Room (option 3351-1) Remove the lower cover from the ball screw.	 <p>xx2100002405</p>
5	For robots with protection class IP54 (option 3350-540) For robots with protection type Clean Room (option 3351-1) Remove the screws on the flange with bearing.	 <p>xx2100002406</p>
6	For robots with protection class IP54 (option 3350-540) For robots with protection type Clean Room (option 3351-1) Remove the flange with bearing.	 <p>xx2100002407</p>

Removing the shaft for Clean Room/ IP54 robots



	Action	Note
1	 <p>DANGER</p> <p>Make sure that all supplies for electrical power, hydraulic pressure, and air pressure are turned off.</p>	

Continues on next page

5 Repair

5.6.1 Replacing the mechanical stopper

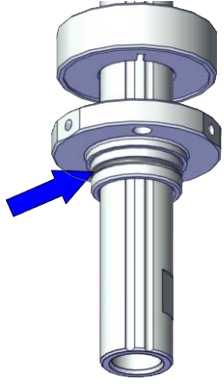
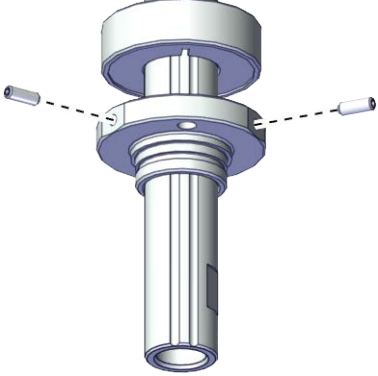

Continued

	Action	Note
2	 CAUTION For robots with protection type Clean Room Always cut the paint with a knife and grind the paint edge when disassembling parts of the robot! See Cut the paint or surface on the robot before replacing parts on page 118 .	
3	For robots with protection class IP54 (option 3350-540) For robots with protection type Clean Room (option 3351-1) Remove the O-ring from the lower housing.	 xx1900001615
4	For robots with protection class IP54 (option 3350-540) For robots with protection type Clean Room (option 3351-1) Loosen the attachment screws.	 xx1900001616
5	For robots with protection class IP54 (option 3350-540) For robots with protection type Clean Room (option 3351-1) Remove the shaft from the mechanical stopper.  Note The shaft is glued to the ball screw. Be careful with the glue when removing the shaft.	

Removing the lower mechanical stopper

	Action	Note
1	 DANGER Make sure that all supplies for electrical power, hydraulic pressure, and air pressure are turned off.	

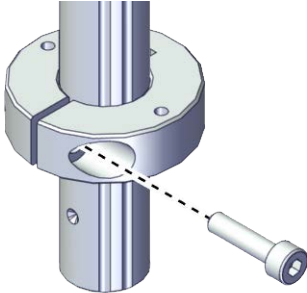
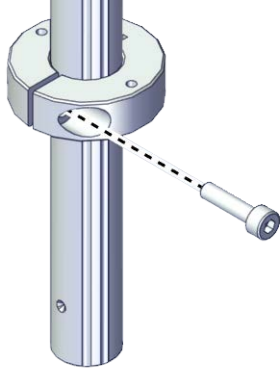
Continues on next page

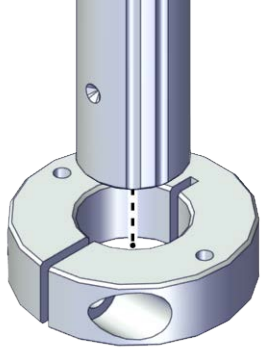
	Action	Note
2	<p> CAUTION</p> <p>For robots with protection type Clean Room Always cut the paint with a knife and grind the paint edge when disassembling parts of the robot! See <i>Cut the paint or surface on the robot before replacing parts on page 118.</i></p>	
3	Remove the screw.	<p>For robots with protection class IP30 (option 3350-300)</p>  <p>xx1800002860</p> <p>For robots with protection class IP54 (option 3350-540) For robots with protection type Clean Room (option 3351-1)</p>  <p>xx1900001642</p>
4	<p>Remove the mechanical stopper.</p> <p> CAUTION</p> <p>If the ball screw nut or ball screw spline nut go out of the screw shaft, the ball screw is destroyed. Be careful when you do any work that may cause this.</p>	 <p>xx1800002861</p>

Continues on next page

5 Repair

5.6.1 Replacing the mechanical stopper

Continued

Refitting the lower mechanical stopper





Use these procedures to refit the lower mechanical stopper.

Refitting the mechanical stopper

	Action	Note
1	<p>For robots with protection type Clean Room: Clean the joints that have been opened and wipe the parts free from particles with spirit on a lint free. See Cut the paint or surface on the robot before replacing parts on page 118</p> <p> Note</p> <p>After all repair work, wipe the Clean Room robot free from particles with spirit on a lint free cloth.</p>	

Continues on next page

5.6.1 Replacing the mechanical stopper
Continued

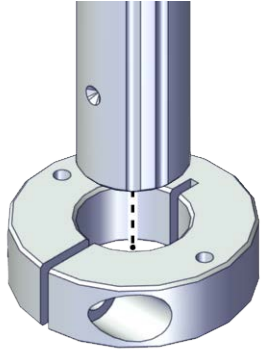
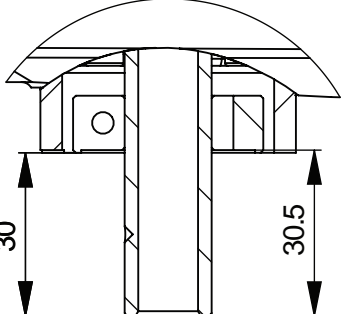
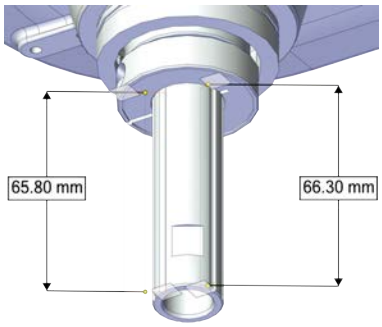
	Action	Note
2	<p>Refit the mechanical stopper to the ball screw at 30.5 mm position to the lower of the ball screw.</p> <p> Note</p> <p>For robots with protection class IP54 (option 3350-540) For robots with protection type Clean Room (option 3351-1) For 180 mm ball screw, refit the mechanical stopper to the ball screw at 65.8 mm position to the lower of the ball screw. For 300 mm ball screw, refit the mechanical stopper to the ball screw at 80.8 mm position to the lower of the ball screw.</p> <p> Tip</p> <p>Make sure that the limit block opening gap is aligned with the ball screw origin point.</p> <p> CAUTION</p> <p>If the ball screw nut or ball screw spline nut go out of the screw shaft, the ball screw is destroyed. Be careful when you do any work that may cause this.</p> <p> Note</p> <p>Be careful with the orientation of the mechanical stopper. The flat side is on the upper side.</p>	 <p>xx1800002861</p> <p>For robots with protection class IP30 (option 3350-300)</p>  <p>xx1900000144</p> <p>For robots with protection class IP54 (option 3350-540) For robots with protection type Clean Room (option 3351-1) For 180 mm ball screw</p>  <p>xx2100002425</p> <p>For 300 mm ball screw</p>

Continues on next page

5 Repair

5.6.1 Replacing the mechanical stopper

Continued

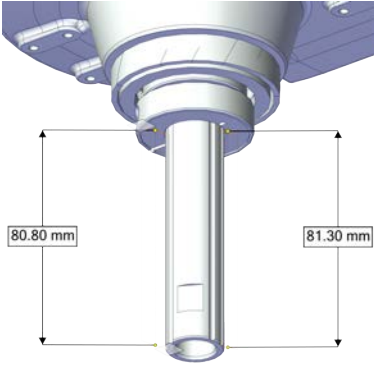
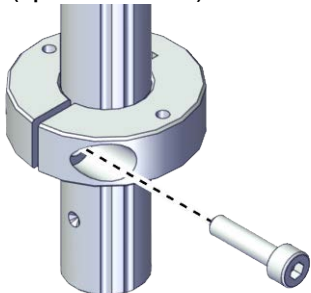
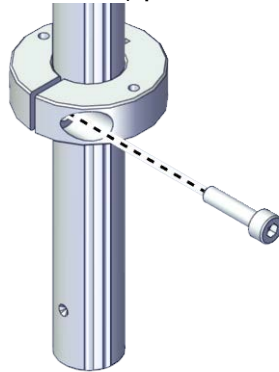
	Action	Note
		 <p>xx2100002426</p>
3	Refit the screw.	<p>Screws: Hex socket head cap screw M4x16 12.9 Lafre 2C2B/FC6.9 (1 pcs) Tightening torque: 6.5 Nm For robots with protection class IP30 (option 3350-300)</p>  <p>xx1800002860</p> <p>For robots with protection class IP54 (option 3350-540) For robots with protection type Clean Room (option 3351-1)</p>  <p>xx1900001642</p>

Continues on next page

Refitting the shaft for Clean Room/ IP54 robots

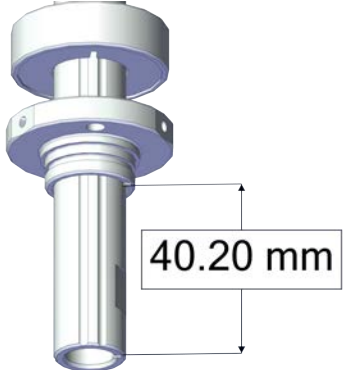
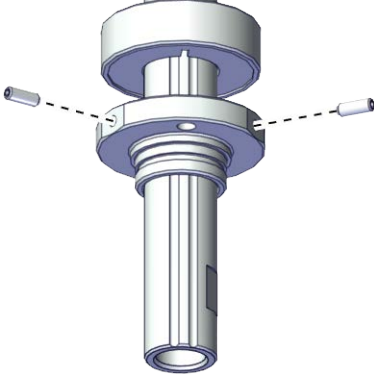

	Action	Note
1	<p>For robots with protection type Clean Room: Clean the joints that have been opened and wipe the parts free from particles with spirit on a lint free. See Cut the paint or surface on the robot before replacing parts on page 118</p> <p> Note</p> <p>After all repair work, wipe the Clean Room robot free from particles with spirit on a lint free cloth.</p>	
2	<p>For robots with protection class IP54 (option 3350-540)</p> <p>For robots with protection type Clean Room (option 3351-1)</p> <p>Install the shaft to the ball screw at 40.2 mm position to the lower of the ball screw.</p>	 <p>xx1900001617</p>
3	<p>For robots with protection class IP54 (option 3350-540)</p> <p>For robots with protection type Clean Room (option 3351-1)</p> <p>Secure the shaft to the ball screw with the screws.</p>	<p>Screws: Hexagon socket set screws with flat point, ISO 4026 stainless steel M3x8 (2 pcs)</p> <p>Tightening torque: 0.4 Nm ±10%</p>  <p>xx1900001616</p>

Continues on next page

5 Repair

5.6.1 Replacing the mechanical stopper

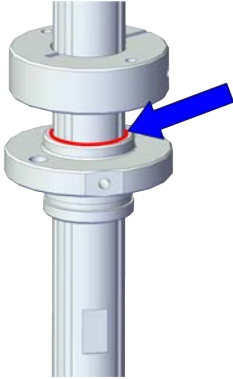
Continued

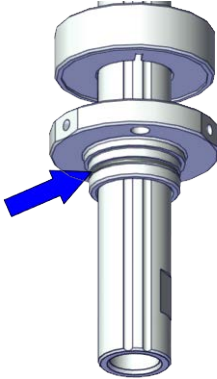
	Action	Note
4	<p>For robots with protection class IP54 (option 3350-540)</p> <p>Apply the glue to the upper contacted zone between the shaft and the ball screw.</p> <p> Note</p> <p>Fulfill the gaps on the ball screw in this contacted zone to make a sealing structure.</p>	 <p>xx1900001805</p>
5	<p>For robots with protection class IP54 (option 3350-540)</p> <p>For robots with protection type Clean Room (option 3351-1)</p> <p>Insert the O-ring to the shaft.</p> <p> Note</p> <p>Replace the o-ring if needed.</p>	 <p>xx1900001615</p>

Refitting the lower cover and the flange with bearing

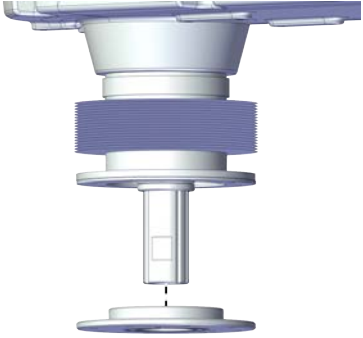
	Action	Note
1	<p>For robots with protection type Clean Room:</p> <p>Clean the joints that have been opened and wipe the parts free from particles with spirit on a lint free. See Cut the paint or surface on the robot before replacing parts on page 118</p> <p> Note</p> <p>After all repair work, wipe the Clean Room robot free from particles with spirit on a lint free cloth.</p>	
2	<p>For robots with protection class IP54 (option 3350-540)</p> <p>For robots with protection type Clean Room (option 3351-1)</p> <p>Install the flange with bearing to the shaft.</p>	 <p>xx2100002407</p>

Continues on next page

5.6.1 Replacing the mechanical stopper
Continued

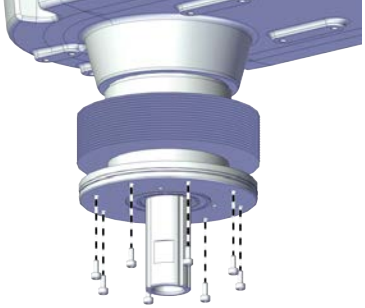
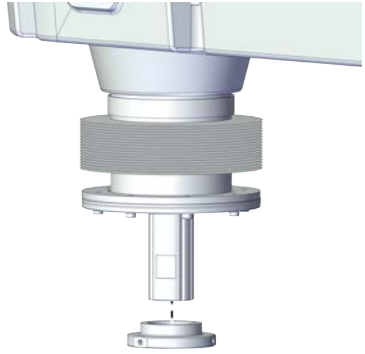
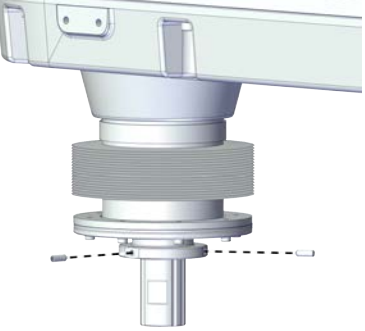
	Action	Note
3	<p>For robots with protection class IP54 (option 3350-540) For robots with protection type Clean Room (option 3351-1) Refit the screws to the flange with bearing.</p>	<p>Screws: Hex socket head cap screw M2.5x6 12.9 Lafre 2C2B/FC6.9 (8 pcs) Tightening torque: 0.8 Nm ±10%</p>  <p>xx2100002406</p>
4	<p>For robots with protection class IP54 (option 3350-540) For robots with protection type Clean Room (option 3351-1) Refit the lower cover to the ball screw.</p>	 <p>xx2100002405</p>
5	<p>For robots with protection class IP54 (option 3350-540) For robots with protection type Clean Room (option 3351-1) Refit the locking screws.</p>	<p>Screws: Hexagon socket set screws with flat point, ISO 4026 stainless steel M3x8 (2 pcs) Tightening torque: 0.4 Nm ±10%</p>  <p>xx2100002404</p>



Continues on next page

5 Repair

5.6.1 Replacing the mechanical stopper

Continued

Concluding procedure

	Action	Note
1	<p>For robots with protection type Clean Room: Seal and paint the joints that have been opened. See Cut the paint or surface on the robot before replacing parts on page 118</p> <p> Note</p> <p>After all repair work, wipe the Clean Room robot free from particles with spirit on a lint free cloth.</p>	
2	<p> DANGER</p> <p>Make sure all safety requirements are met when performing the first test run.</p>	

5.6.2 Replacing the bellows

Location of the bellows

The bellows are located as shown in the figure.

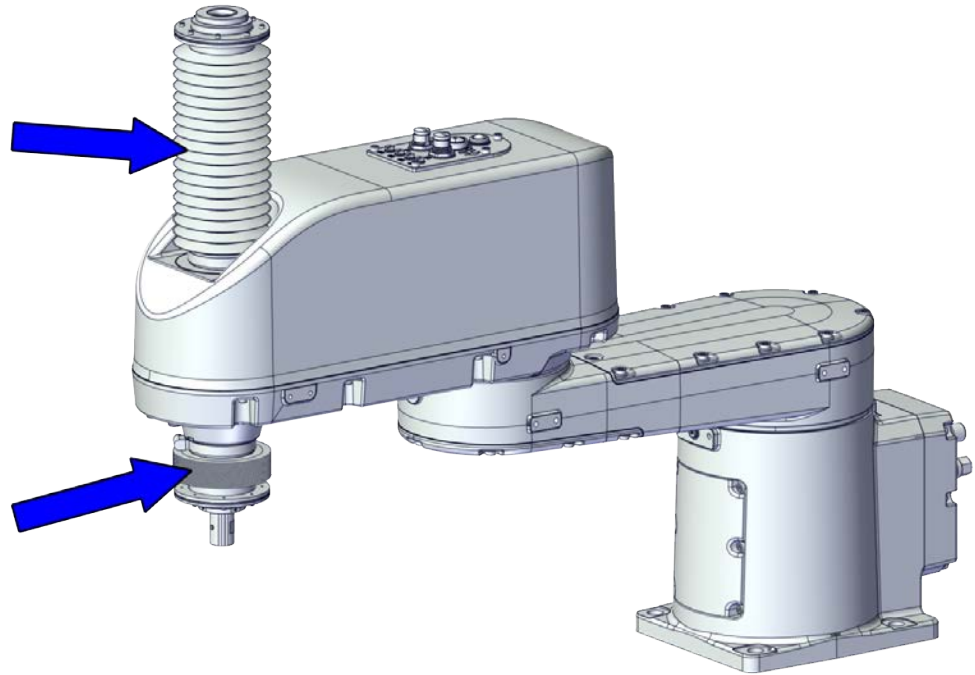

xx2100002397

Required spare parts



Note

The spare part numbers that are listed in the table can be out of date. See the latest spare parts of the IRB 920 via myABB Business Portal, www.abb.com/myABB.

Spare part	Article number	Note
Bellow 140	3HAC073494-001	Used with protection type Clean Room.
Below, Long stroke	3HAC073495-001	Used with protection type Clean Room.
Bellow Gasket	3HAC071547-001	Replace if damaged.
Top Cover	3HAC073487-001	Replace if damaged.
Lower Cover	3HAC073491-001	Replace if damaged.
Extension shaft	3HAC073489-001	Replace if damaged.
Extension shaft, Long stroke	3HAC073492-001	Replace if damaged.
Gasket	3HAC066658-001	Used with protection class IP54.
Shaft	3HAC073490-001	Replace if damaged.

Continues on next page

5 Repair

5.6.2 Replacing the bellows

Continued

Spare part	Article number	Note
O-ring	3HAC061327-023	Replace if damaged.
Flange with bearing	3HAC081473-001	Replace if damaged.

Required tools and equipment

Equipment	Article number	Note
Standard toolkit	-	Content is defined in section Standard toolkit on page 996 .
Calibration toolbox, Axis Calibration	3HAC055412-001	Delivered as a set of calibration tools. Required if Axis Calibration is the valid calibration method for the robot.
24 VDC power supply	-	Used to release the motor brakes.
Sonic tension meter	-	Used for measuring the timing belt tension.

Required consumables

Consumable	Article number	Note
Cable straps	-	
Grease	-	THK AFA
Locking liquid	3HAB7116-1	Loctite 243
Sealing compound	3HAC026759-002	Sikaflex 521 FC For robots with protection type Clean Room.

Deciding calibration routine

Decide which calibration routine to be used, based on the information in the table. Depending on which routine is chosen, action might be required prior to beginning the repair work of the robot, see the table.

	Action	Note
1	Decide which calibration routine to use for calibrating the robot. <ul style="list-style-type: none">Reference calibration. External cable packages (DressPack) and tools can stay fitted on the robot.Fine calibration. All external cable packages (DressPack) and tools must be removed from the robot.	
	If the robot is to be calibrated with reference calibration: Find previous reference values for the axis or create new reference values. These values are to be used after the repair procedure is completed, for calibration of the robot. If no previous reference values exist, and no new reference values can be created, then reference calibration is not possible.	Follow the instructions given in the reference calibration routine on the FlexPendant to create reference values. Creating new values requires possibility to move the robot. Read more about reference calibration for Axis Calibration in Reference calibration routine on page 957 .



Continues on next page

Action	Note
<p>If the robot is to be calibrated with fine calibration:</p> <p>Remove all external cable packages (DressPack) and tools from the robot.</p>	



Removing the upper bellow parts

Use these procedures to remove the upper bellow parts.

Preparations before removing the upper bellow parts

	Action	Note
1	Decide which calibration routine to use, and take actions accordingly prior to beginning the repair procedure.	
2	 DANGER Turn off all: <ul style="list-style-type: none"> • electric power supply • hydraulic pressure supply • air pressure supply to the robot, before entering the safeguarded space.	
3	 CAUTION For robots with protection type Clean Room Always cut the paint with a knife and grind the paint edge when disassembling parts of the robot! See Cut the paint or surface on the robot before replacing parts on page 118 .	

Removing the top cover and the flange with bearing



	Action	Note
1	 DANGER Make sure that all supplies for electrical power, hydraulic pressure, and air pressure are turned off.	
2	 CAUTION For robots with protection type Clean Room Always cut the paint with a knife and grind the paint edge when disassembling parts of the robot! See Cut the paint or surface on the robot before replacing parts on page 118 .	

Continues on next page

5 Repair



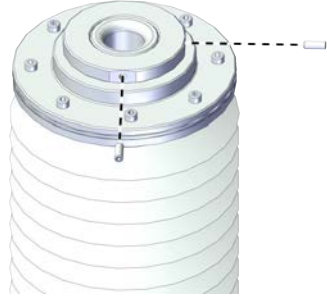

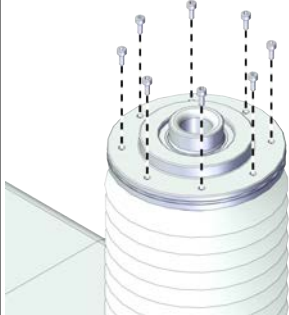
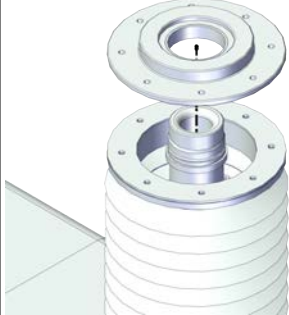
5.6.2 Replacing the bellows

Continued

	Action	Note
3	<p>For robots with protection class IP54 (option 3350-540) For robots with protection type Clean Room (option 3351-1) Loose the locking screws.</p>	 <p>xx2100002398</p>
4	<p>For robots with protection class IP54 (option 3350-540) For robots with protection type Clean Room (option 3351-1) Remove the top cover from the ball screw.</p>	 <p>xx2100002399</p>
5	<p>For robots with protection class IP54 (option 3350-540) For robots with protection type Clean Room (option 3351-1) Remove the screws on the flange with bearing.</p>	 <p>xx2100002401</p>
6	<p>For robots with protection class IP54 (option 3350-540) For robots with protection type Clean Room (option 3351-1) Remove the flange with bearing.</p>	 <p>xx2100002402</p>

Continues on next page

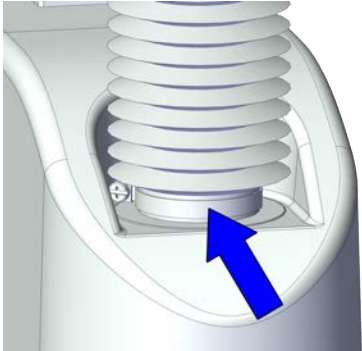
Removing the upper bellow

	Action	Note
1	 DANGER Make sure that all supplies for electrical power, hydraulic pressure, and air pressure are turned off.	
2	 CAUTION For robots with protection type Clean Room Always cut the paint with a knife and grind the paint edge when disassembling parts of the robot! See Cut the paint or surface on the robot before replacing parts on page 118 .	
3	For robots with protection class IP54 (option 3350-540) For robots with protection type Clean Room (option 3351-1) Loosen the lower bellow clamp by loosening the screw and pull the clamp apart slightly.	 xx2100002400
4	For robots with protection class IP54 (option 3350-540) For robots with protection type Clean Room (option 3351-1) Remove the bellow from the outer arm cover.  Note For robots with protection class IP54 (option 3350-540) Clean the outer arm casting cover from the glue if it will be reused.	
5	For robots with protection class IP54 (option 3350-540) For robots with protection type Clean Room (option 3351-1) Take out the released the bellow.  Note For robots with protection class IP54 (option 3350-540) Clean the bellow from the glue if it will be reused.	

Continues on next page

5 Repair

5.6.2 Replacing the bellows

Continued



Refitting the upper bellow parts

Use these procedures to refit the upper bellow parts.

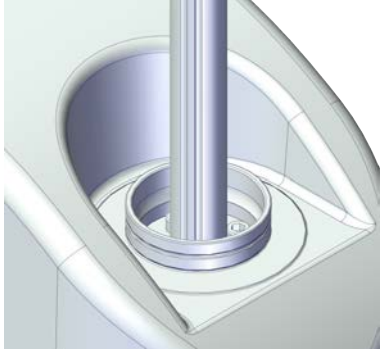
Refitting the upper bellow to outer arm

	Action	Note
1	<p>For robots with protection type Clean Room: Clean the joints that have been opened and wipe the parts free from particles with spirit on a lint free. See Cut the paint or surface on the robot before replacing parts on page 118</p> <p> Note</p> <p>After all repair work, wipe the Clean Room robot free from particles with spirit on a lint free cloth.</p>	
2	<p>For robots with protection class IP54 (option 3350-540) Apply the glue to the outer arm.</p>	 xx2100002403
3	<p>For robots with protection class IP54 (option 3350-540) For robots with protection type Clean Room (option 3351-1) Install the bellow to the extension shaft.</p>	

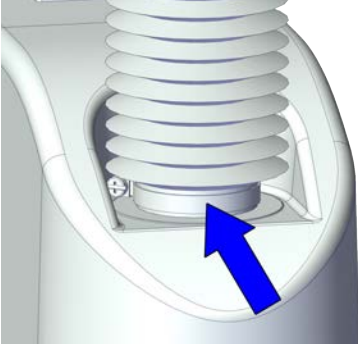
Continues on next page

	Action	Note
4	<p>For robots with protection class IP54 (option 3350-540) For robots with protection type Clean Room (option 3351-1) Pull the lower end of the bellow to the outer arm.</p> <p> Tip</p> <p>For robots with protection class IP54 (option 3350-540) Hold the bellow for a little while until it's attached to the housing.</p>	<p>Tightening torque: 2.5 Nm \pm10%</p> 
5	<p>For robots with protection class IP54 (option 3350-540) For robots with protection type Clean Room (option 3351-1) Secure them with the clamp.</p> <p> Tip</p> <p>The opening part of the clamp should be in the opposite position to the gap on the bellow gasket.</p>	<p>xx2100002400</p>

Refitting the top cover and the flange with bearing

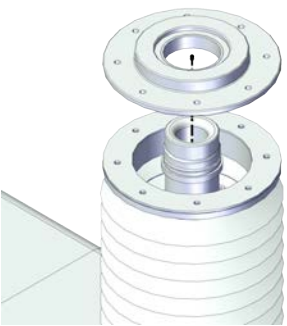

	Action	Note
1	<p>For robots with protection type Clean Room: Clean the joints that have been opened and wipe the parts free from particles with spirit on a lint free. See Cut the paint or surface on the robot before replacing parts on page 118</p> <p> Note</p> <p>After all repair work, wipe the Clean Room robot free from particles with spirit on a lint free cloth.</p>	
2	<p>For robots with protection class IP54 (option 3350-540) For robots with protection type Clean Room (option 3351-1) Install the flange with bearing to the extension shaft.</p>	 <p>xx2100002402</p>

Continues on next page

5 Repair

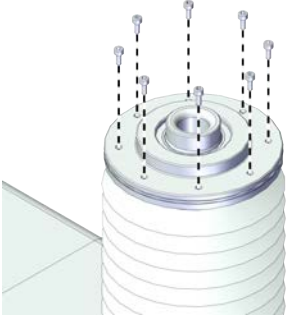

5.6.2 Replacing the bellows

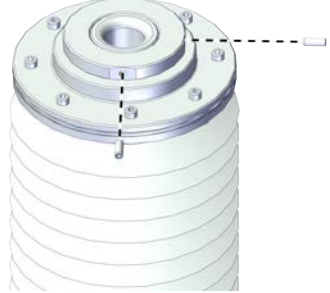
Continued

	Action	Note
3	<p>For robots with protection class IP54 (option 3350-540) For robots with protection type Clean Room (option 3351-1) Refit the screws to the flange with bearing.</p>	<p>Screws: Hex socket head cap screw M2.5x6 12.9 Lafre 2C2B/FC6.9 (8 pcs) Tightening torque: 0.8 Nm \pm10%</p>  <p>xx2100002401</p>
4	<p>For robots with protection class IP54 (option 3350-540) For robots with protection type Clean Room (option 3351-1) Refit the top cover to the ball screw.</p> <p> Tip</p> <p>The top surface of the cover should be flush with the top end of the ball screw.</p>	 <p>xx2100002399</p>
5	<p>For robots with protection class IP54 (option 3350-540) For robots with protection type Clean Room (option 3351-1) Refit the locking screws.</p>	<p>Screws: Hexagon socket set screws with flat point, ISO 4026 stainless steel M3x8 (2 pcs) Tightening torque: 0.4 Nm \pm10%</p>  <p>xx2100002398</p>

Continues on next page



Concluding procedure

	Action	Note
1	<p>For robots with protection type Clean Room: Seal and paint the joints that have been opened. See Cut the paint or surface on the robot before replacing parts on page 118</p> <p> Note</p> <p>After all repair work, wipe the Clean Room robot free from particles with spirit on a lint free cloth.</p>	
2	<p> DANGER</p> <p>Make sure all safety requirements are met when performing the first test run.</p>	

Removing the lower bellow parts

Use these procedures to remove the lower bellow parts.

Preparations before removing the lower bellow parts

	Action	Note
1	Decide which calibration routine to use, and take actions accordingly prior to beginning the repair procedure.	
2	<p> DANGER</p> <p>Turn off all:</p> <ul style="list-style-type: none"> • electric power supply • hydraulic pressure supply • air pressure supply <p>to the robot, before entering the safeguarded space.</p>	
3	<p> CAUTION</p> <p>For robots with protection type Clean Room Always cut the paint with a knife and grind the paint edge when disassembling parts of the robot! See Cut the paint or surface on the robot before replacing parts on page 118.</p>	

Removing the lower cover and the flange with bearing

	Action	Note
1	<p> DANGER</p> <p>Make sure that all supplies for electrical power, hydraulic pressure, and air pressure are turned off.</p>	

Continues on next page

5 Repair

5.6.2 Replacing the bellows



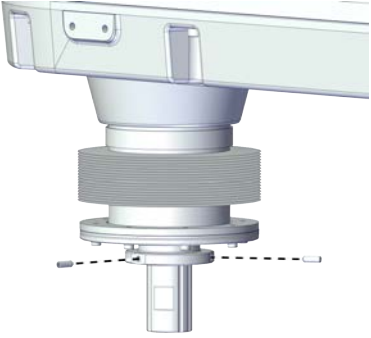
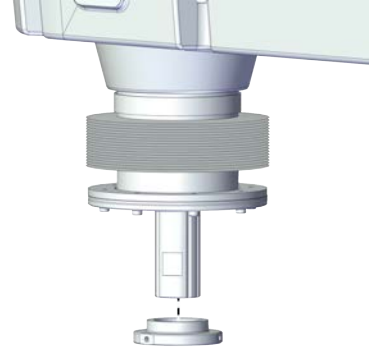
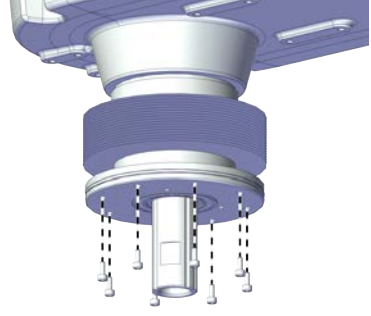

Continued

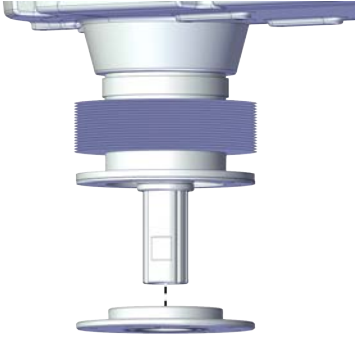
	Action	Note
2	<p> CAUTION</p> <p>For robots with protection type Clean Room Always cut the paint with a knife and grind the paint edge when disassembling parts of the robot! See Cut the paint or surface on the robot before replacing parts on page 118.</p>	
3	<p>For robots with protection class IP54 (option 3350-540) For robots with protection type Clean Room (option 3351-1) Loose the locking screws.</p>	 <p>xx2100002404</p>
4	<p>For robots with protection class IP54 (option 3350-540) For robots with protection type Clean Room (option 3351-1) Remove the lower cover from the ball screw.</p>	 <p>xx2100002405</p>
5	<p>For robots with protection class IP54 (option 3350-540) For robots with protection type Clean Room (option 3351-1) Remove the screws on the flange with bearing.</p>	 <p>xx2100002406</p>

Continues on next page

	Action	Note
6	<p>For robots with protection class IP54 (option 3350-540)</p> <p>For robots with protection type Clean Room (option 3351-1)</p> <p>Remove the flange with bearing.</p>	 <p>xx2100002407</p>

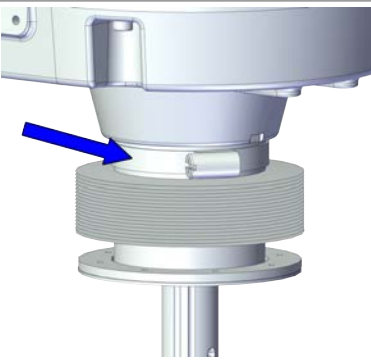

Removing the lower bellow

	Action	Note
1	 <p>DANGER</p> <p>Make sure that all supplies for electrical power, hydraulic pressure, and air pressure are turned off.</p>	
2	 <p>CAUTION</p> <p>For robots with protection type Clean Room</p> <p>Always cut the paint with a knife and grind the paint edge when disassembling parts of the robot! See Cut the paint or surface on the robot before replacing parts on page 118.</p>	
3	<p>For robots with protection class IP54 (option 3350-540)</p> <p>For robots with protection type Clean Room (option 3351-1)</p> <p>Loosen the upper bellow clamp by loosening the screw and pull the clamp apart slightly.</p>	
4	<p>For robots with protection class IP54 (option 3350-540)</p> <p>For robots with protection type Clean Room (option 3351-1)</p> <p>Remove the bellow from the outer arm.</p>  <p>Note</p> <p>For robots with protection class IP54 (option 3350-540)</p> <p>Clean the bellow from the glue if it will be reused.</p>	<p>xx2100002408</p>

5 Repair

5.6.2 Replacing the bellows

Continued

	Action	Note
5	<p>For robots with protection class IP54 (option 3350-540)</p> <p>Remove the bellow gasket from the bellow.</p> <p> Note</p> <p>Clean the bellow gasket from the glue if it will be reused.</p> <p> Note</p> <p>Be careful when removing the bellow gaskets. If any broken, replace it.</p>	



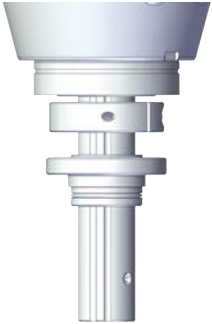

Refitting the lower bellow parts

Use these procedures to refit the lower bellow parts.

Refitting the lower bellow to outer arm

	Action	Note
1	<p>For robots with protection type Clean Room:</p> <p>Clean the joints that have been opened and wipe the parts free from particles with spirit on a lint free. See Cut the paint or surface on the robot before replacing parts on page 118</p> <p> Note</p> <p>After all repair work, wipe the Clean Room robot free from particles with spirit on a lint free cloth.</p>	
2	<p>For robots with protection class IP54 (option 3350-540)</p> <p>Apply the glue to the outer arm.</p>	 <p>xx2100002409</p>
3	<p>For robots with protection class IP54 (option 3350-540)</p> <p>For robots with protection type Clean Room (option 3351-1)</p> <p>Install the bellow to the shaft.</p>	

Continues on next page

	Action	Note
4	<p>For robots with protection class IP54 (option 3350-540)</p> <p>For robots with protection type Clean Room (option 3351-1)</p> <p>Pull the upper end of the bellow to the outer arm.</p> <p> Tip</p> <p>For robots with protection class IP54 (option 3350-540)</p> <p>Hold the bellow for a little while until it's attached to the housing.</p>	<p>Tightening torque: 2.5 Nm \pm10%</p> 
5	<p>For robots with protection class IP54 (option 3350-540)</p> <p>Install the bellow gaskets to the bellow.</p> <p> Tip</p> <p>The angle between the gap on the bellow gasket and gap on the inner bellow gasket should be 90 degrees.</p>	xx2100002408
6	<p>For robots with protection class IP54 (option 3350-540)</p> <p>For robots with protection type Clean Room (option 3351-1)</p> <p>Secure them with the clamp.</p> <p> Tip</p> <p>The opening part of the clamp should be in the opposite position to the gap on the bellow gasket.</p>	

Refitting the lower cover and the flange with bearing

	Action	Note
1	<p>For robots with protection type Clean Room:</p> <p>Clean the joints that have been opened and wipe the parts free from particles with spirit on a lint free. See Cut the paint or surface on the robot before replacing parts on page 118</p> <p> Note</p> <p>After all repair work, wipe the Clean Room robot free from particles with spirit on a lint free cloth.</p>	

Continues on next page

5 Repair

5.6.2 Replacing the bellows

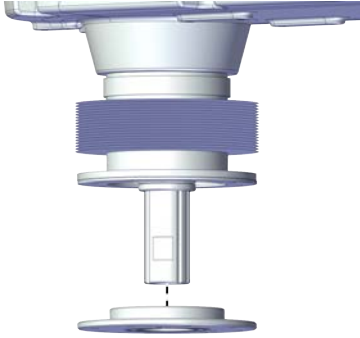
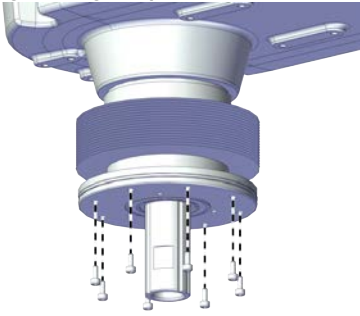
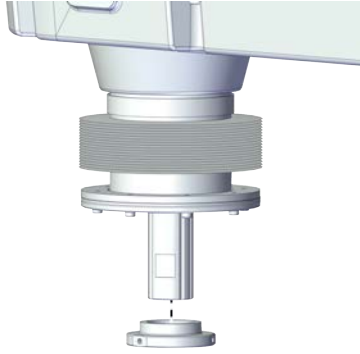

Continued

	Action	Note
2	<p>For robots with protection class IP54 (option 3350-540)</p> <p>For robots with protection type Clean Room (option 3351-1)</p> <p>Install the flange with bearing to the shaft.</p>	 <p>xx2100002407</p>
3	<p>For robots with protection class IP54 (option 3350-540)</p> <p>For robots with protection type Clean Room (option 3351-1)</p> <p>Refit the screws to the flange with bearing.</p>	<p>Screws: Hex socket head cap screw M2.5x6 12.9 Lafre 2C2B/FC6.9 (8 pcs)</p> <p>Tightening torque: 0.8 Nm \pm10%</p>  <p>xx2100002406</p>
4	<p>For robots with protection class IP54 (option 3350-540)</p> <p>For robots with protection type Clean Room (option 3351-1)</p> <p>Refit the lower cover to the ball screw.</p>	 <p>xx2100002405</p>

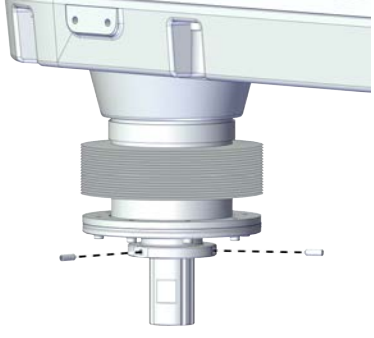
Continues on next page

	Action	Note
5	<p>For robots with protection class IP54 (option 3350-540)</p> <p>For robots with protection type Clean Room (option 3351-1)</p> <p>Refit the locking screws.</p>	<p>Screws: Hexagon socket set screws with flat point, ISO 4026 stainless steel M3x8 (2 pcs)</p> <p>Tightening torque: 0.4 Nm \pm10%</p>  <p>xx2100002404</p>

Concluding procedure

	Action	Note
1	<p>For robots with protection type Clean Room:</p> <p>Seal and paint the joints that have been opened. See Cut the paint or surface on the robot before replacing parts on page 118</p> <p> Note</p> <p>After all repair work, wipe the Clean Room robot free from particles with spirit on a lint free cloth.</p>	
2	<p> DANGER</p> <p>Make sure all safety requirements are met when performing the first test run.</p>	

5 Repair

5.6.3 Replacing the pulley on the ball screw upper position

5.6.3 Replacing the pulley on the ball screw upper position

Location of the pulley

The pulley is located as shown in the figure.

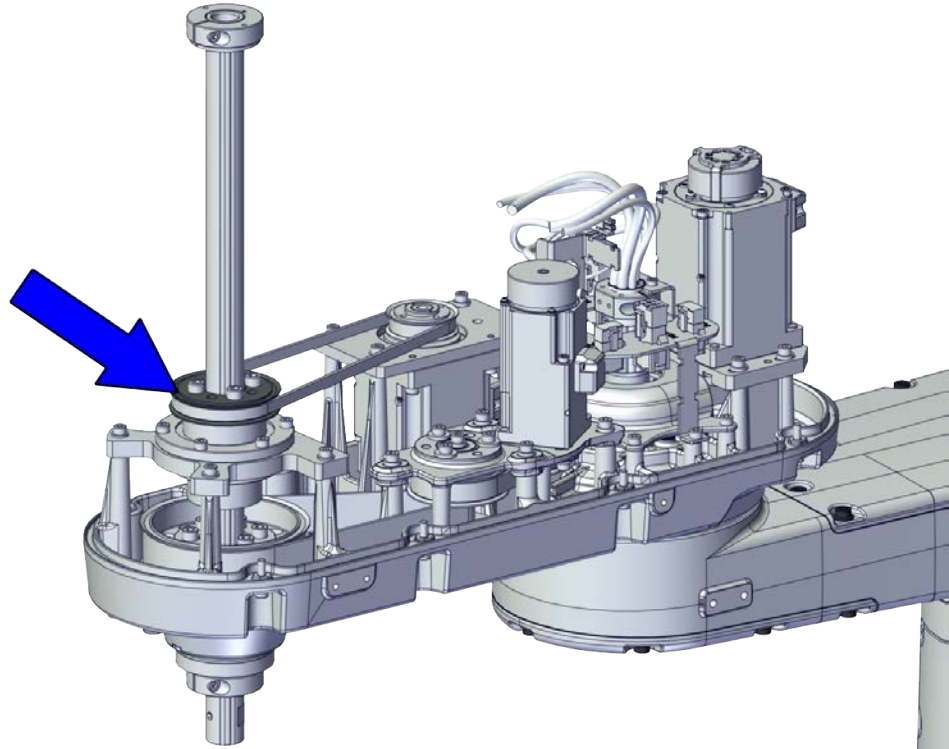

xx2100001016

Required spare parts



Note

The spare part numbers that are listed in the table can be out of date. See the latest spare parts of the IRB 920 via myABB Business Portal, www.abb.com/myABB.

Spare part	Article number	Note
Ax3 pulley Z2	3HAC070480-001	
Mechanical-Stop top, D20	3HAC073068-001	With bolt
Timing belt A3	3HAC070464-001	

Required tools and equipment

Equipment	Article number	Note
Standard toolkit	-	Content is defined in section Standard toolkit on page 996 .

Continues on next page

5.6.3 Replacing the pulley on the ball screw upper position

Continued

Equipment	Article number	Note
Calibration toolbox, Axis Calibration	3HAC055412-001	Delivered as a set of calibration tools. Required if Axis Calibration is the valid calibration method for the robot.
24 VDC power supply	-	Used to release the motor brakes.
Sonic tension meter	-	Used for measuring the timing belt tension.

Required consumables

Consumable	Article number	Note
Cable straps	-	
Grease	-	THK AFA

Deciding calibration routine

Decide which calibration routine to be used, based on the information in the table. Depending on which routine is chosen, action might be required prior to beginning the repair work of the robot, see the table.

	Action	Note
1	Decide which calibration routine to use for calibrating the robot. <ul style="list-style-type: none"> Reference calibration. External cable packages (DressPack) and tools can stay fitted on the robot. Fine calibration. All external cable packages (DressPack) and tools must be removed from the robot. 	
	If the robot is to be calibrated with reference calibration: Find previous reference values for the axis or create new reference values. These values are to be used after the repair procedure is completed, for calibration of the robot. If no previous reference values exist, and no new reference values can be created, then reference calibration is not possible.	Follow the instructions given in the reference calibration routine on the FlexPendant to create reference values. Creating new values requires possibility to move the robot. Read more about reference calibration for Axis Calibration in Reference calibration routine on page 957 .
	If the robot is to be calibrated with fine calibration: Remove all external cable packages (DressPack) and tools from the robot.	

Removing the pulley on the ball screw upper position

Use these procedures to remove the pulley.

Preparations before removing the pulley



	Action	Note
1	Decide which calibration routine to use, and take actions accordingly prior to beginning the repair procedure.	

Continues on next page



5 Repair

5.6.3 Replacing the pulley on the ball screw upper position

Continued

	Action	Note
2	<p>If there is no enough space for the maintenance work, remove the robot from the wall and place it on the maintenance bracket.</p> <p> CAUTION</p> <p>Do not lay down the robot during the transportation, always keep it straight. If the robot lay down in any situation, the grease may come out from gearbox.</p>	
3	<p> DANGER</p> <p>Turn off all:</p> <ul style="list-style-type: none"> • electric power supply • hydraulic pressure supply • air pressure supply <p>to the robot, before entering the safeguarded space.</p>	
4	<p> CAUTION</p> <p>For robots with protection type Clean Room Always cut the paint with a knife and grind the paint edge when disassembling parts of the robot! See Cut the paint or surface on the robot before replacing parts on page 118.</p>	



Removing the process hub screws

	Action	Note
1	<p> DANGER</p> <p>Make sure that all supplies for electrical power, hydraulic pressure, and air pressure are turned off.</p>	
2	<p> CAUTION</p> <p>For robots with protection type Clean Room Always cut the paint with a knife and grind the paint edge when disassembling parts of the robot! See Cut the paint or surface on the robot before replacing parts on page 118.</p>	

Continues on next page

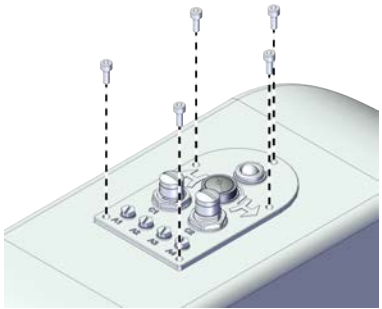
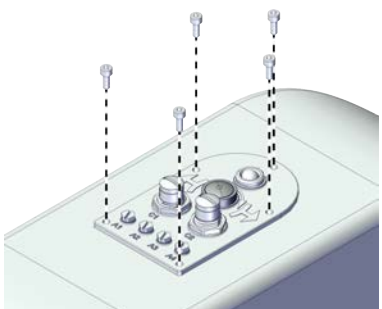

5.6.3 Replacing the pulley on the ball screw upper position

Continued

	Action	Note
3	<p>Remove the screws on the process hub.</p> <p> Note</p> <p>For robots with protection class IP54 (option 3350-540)</p> <p>For robots with protection type Clean Room (option 3351-1)</p> <p>Remove the screws on the process hub and take out the gasket.</p> <p> Tip</p> <p>Check the gasket and replace it if needed.</p>	<p>For robots with protection class IP30</p>  <p>xx2100000932</p> <p>For robots with protection class IP54 (option 3350-540)</p> <p>For robots with protection type Clean Room (option 3351-1)</p>  <p>xx2100000932</p>
4	Insert the process hub to the outer arm.	

For Clean Room/ IP54 robots

Removing the top cover and the flange with bearing



	Action	Note
1	<p> DANGER</p> <p>Make sure that all supplies for electrical power, hydraulic pressure, and air pressure are turned off.</p>	
2	<p> CAUTION</p> <p>For robots with protection type Clean Room</p> <p>Always cut the paint with a knife and grind the paint edge when disassembling parts of the robot!</p> <p>See Cut the paint or surface on the robot before replacing parts on page 118.</p>	

Continues on next page

5 Repair

5.6.3 Replacing the pulley on the ball screw upper position

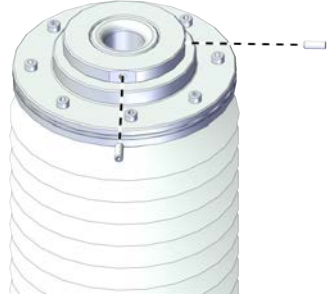

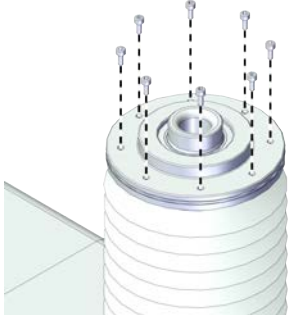
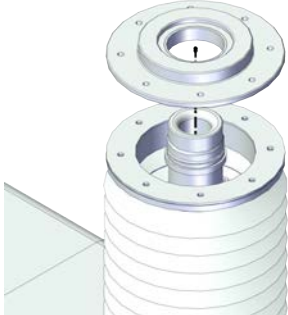

Continued

	Action	Note
3	<p>For robots with protection class IP54 (option 3350-540) For robots with protection type Clean Room (option 3351-1) Loose the locking screws.</p>	 <p>xx2100002398</p>
4	<p>For robots with protection class IP54 (option 3350-540) For robots with protection type Clean Room (option 3351-1) Remove the top cover from the ball screw.</p>	 <p>xx2100002399</p>
5	<p>For robots with protection class IP54 (option 3350-540) For robots with protection type Clean Room (option 3351-1) Remove the screws on the flange with bearing.</p>	 <p>xx2100002401</p>
6	<p>For robots with protection class IP54 (option 3350-540) For robots with protection type Clean Room (option 3351-1) Remove the flange with bearing.</p>	 <p>xx2100002402</p>

Continues on next page

5.6.3 Replacing the pulley on the ball screw upper position
Continued

Removing the cover of the outer arm

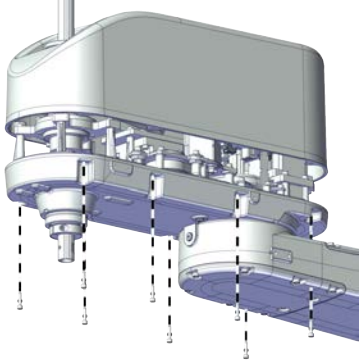
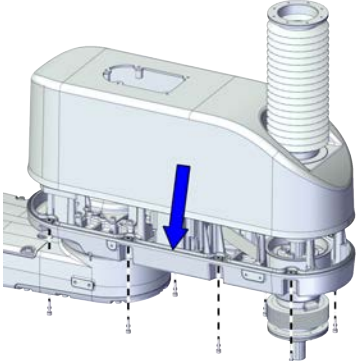
	Action	Note
1	 DANGER Make sure that all supplies for electrical power, hydraulic pressure, and air pressure are turned off.	
2	 CAUTION For robots with protection type Clean Room Always cut the paint with a knife and grind the paint edge when disassembling parts of the robot! See <i>Cut the paint or surface on the robot before replacing parts on page 118.</i>	
3	<p>Remove the screws on the cover of the outer arm and remove the cover.</p>  Note For robots with protection class IP54 (option 3350-540) For robots with protection type Clean Room (option 3351-1) Remove the cover with bellow and housing.  Note The bellow does not need to be removed separately.  Tip Check the gasket and replace it if needed.	<p>For robots with protection class IP30</p>  <p>xx210000933</p> <p>For robots with protection class IP54 (option 3350-540) For robots with protection type Clean Room (option 3351-1)</p>  <p>xx2100002427</p>



Continues on next page

5 Repair

5.6.3 Replacing the pulley on the ball screw upper position



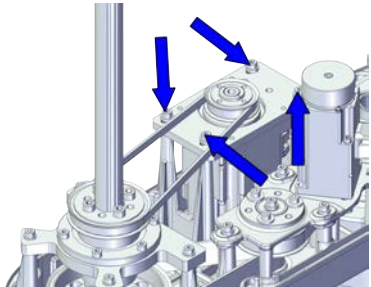
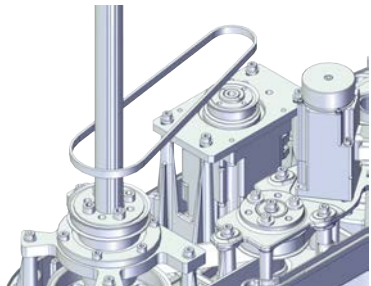

Continued

Removing the axis-3 timing belt

	Action	Note
1	 DANGER Make sure that all supplies for electrical power, hydraulic pressure, and air pressure are turned off.	
2	 CAUTION For robots with protection type Clean Room Always cut the paint with a knife and grind the paint edge when disassembling parts of the robot! See Cut the paint or surface on the robot before replacing parts on page 118 .	
3	 DANGER Make sure that the ball screw is supported with something. The sudden drop of the ball screw due the lost of the axis-3 motor may cause danger.	
4	Loosen the screws of the axis-3 motor sub-assembly to let the axis-3 timing belt free.	 xx2100001078
5	Remove the timing belt.	 xx2100001079

Continues on next page

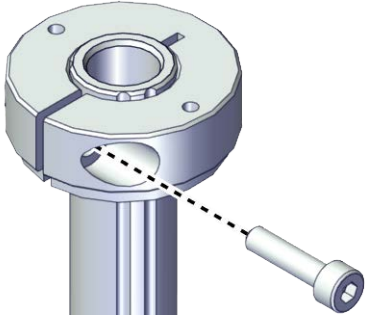
Removing the upper mechanical stopper

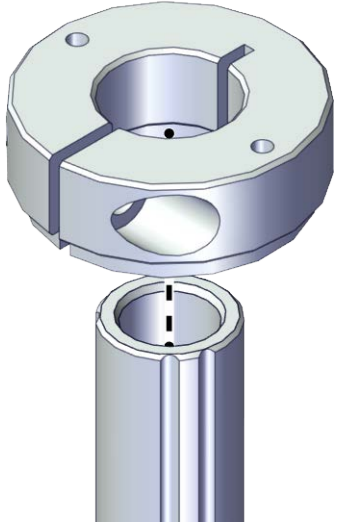
	Action	Note
1	 <p>DANGER</p> <p>Make sure that all supplies for electrical power, hydraulic pressure, and air pressure are turned off.</p>	
2	 <p>CAUTION</p> <p>For robots with protection type Clean Room Always cut the paint with a knife and grind the paint edge when disassembling parts of the robot! See Cut the paint or surface on the robot before replacing parts on page 118.</p>	
3	<p>Remove the screw.</p>	 <p>xx1800002858</p>
4	<p>Remove the mechanical stopper.</p>  <p>Tip</p> <p>Hold the ball screw to prevent it from dropping. Or the ball screw may be destroyed.</p>  <p>CAUTION</p> <p>If the ball screw nut or ball screw spline nut go out of the screw shaft, the ball screw is destroyed. Be careful when you do any work that may cause this.</p>	 <p>xx1800002859</p>





Continues on next page

5 Repair

5.6.3 Replacing the pulley on the ball screw upper position

Continued

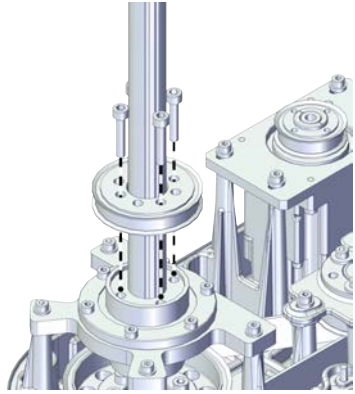
Removing the pulley on the ball screw upper position

	Action	Note
1	 DANGER Make sure that all supplies for electrical power, hydraulic pressure, and air pressure are turned off.	
2	 ELECTROSTATIC DISCHARGE (ESD) The unit is sensitive to ESD. Before handling the unit read the safety information in section The unit is sensitive to ESD on page 49 .	
3	 CAUTION For robots with protection type Clean Room Always cut the paint with a knife and grind the paint edge when disassembling parts of the robot! See Cut the paint or surface on the robot before replacing parts on page 118 .	
4	Remove the screws.	
5	Remove the pulley carefully.  Tip Hold the ball screw to prevent it from dropping. Or the ball screw may be destroyed.  CAUTION If the ball screw nut or ball screw spline nut go out of the screw shaft, the ball screw is destroyed. Be careful when you do any work that may cause this.	

Refitting the pulley on the ball screw upper position

Use these procedures to refit the pulley.





Refitting the pulley on the ball screw upper position

	Action	Note
1	 ELECTROSTATIC DISCHARGE (ESD) The unit is sensitive to ESD. Before handling the unit read the safety information in section The unit is sensitive to ESD on page 49 .	

Continues on next page

5.6.3 Replacing the pulley on the ball screw upper position

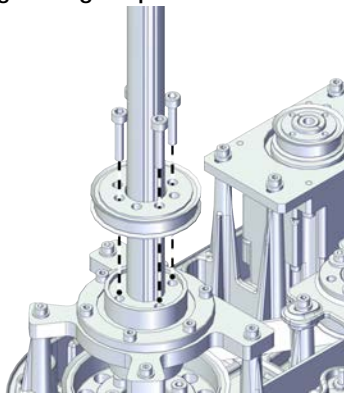
Continued

	Action	Note
2	<p>For robots with protection type Clean Room: Clean the joints that have been opened and wipe the parts free from particles with spirit on a lint free. See Cut the paint or surface on the robot before replacing parts on page 118</p> <p> Note</p> <p>After all repair work, wipe the Clean Room robot free from particles with spirit on a lint free cloth.</p>	
3	<p>Refit the pulley to the ball screw carefully.</p> <p> Tip</p> <p>Hold the ball screw to prevent it from dropping. Or the ball screw may be destroyed.</p> <p> CAUTION</p> <p>If the ball screw nut or ball screw spline nut go out of the screw shaft, the ball screw is destroyed. Be careful when you do any work that may cause this.</p>	<p>Screws: Hex socket head cap screw M5x25 12.9 Lafre 2C2B/FC6.9 (4 pcs) Tightening torque: 4.4 Nm \pm10%</p>  <p>xx2100001080</p>
4	<p>Refit the screws.</p> <p> Tip</p> <p>Secure with the stopping tool to prevent the pulley from rotating.</p>	

Refitting the upper mechanical stopper



	Action	Note
1	<p>For robots with protection type Clean Room: Clean the joints that have been opened and wipe the parts free from particles with spirit on a lint free. See Cut the paint or surface on the robot before replacing parts on page 118</p> <p> Note</p> <p>After all repair work, wipe the Clean Room robot free from particles with spirit on a lint free cloth.</p>	

Continues on next page

5 Repair

5.6.3 Replacing the pulley on the ball screw upper position

Continued

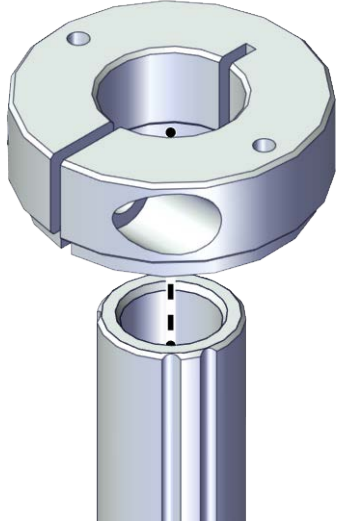
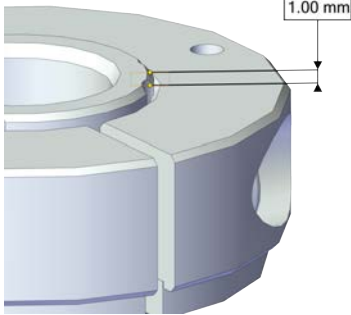
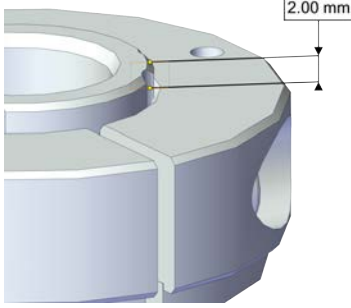
	Action	Note
2	<p>Refit the mechanical stopper to the ball screw at 1 mm position to the upper of the ball screw.</p> <p> Note</p> <p>For robots with protection class IP54 (option 3350-540) For robots with protection type Clean Room (option 3351-1)</p> <p>Refit the mechanical stopper to the ball screw at 2 mm position to the upper of the ball screw.</p> <p> Tip</p> <p>Hold the ball screw to prevent it from dropping. Or the ball screw may be destroyed.</p> <p> CAUTION</p> <p>If the ball screw nut or ball screw spline nut go out of the screw shaft, the ball screw is destroyed. Be careful when you do any work that may cause this.</p>	 <p>xx1800002859</p> <p>For robots with protection class IP30 (option 3350-300)</p>  <p>xx1900002012</p> <p>For robots with protection class IP54 (option 3350-540) For robots with protection type Clean Room (option 3351-1)</p>  <p>xx1900002011</p>

Continues on next page

5.6.3 Replacing the pulley on the ball screw upper position

Continued

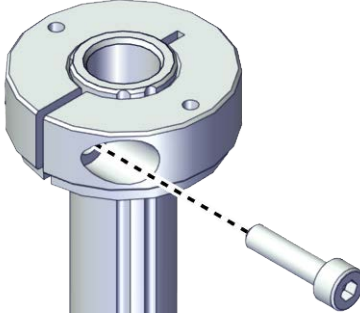
	Action	Note
3	Refit the screw.	<p>Screws: Hex socket head cap screw M4x16 12.9 Lafre 2C2B/FC6.9 (1 pcs) Tightening torque: 6.5 Nm</p>  <p>xx1800002858</p>

Refitting the axis-3 timing belt

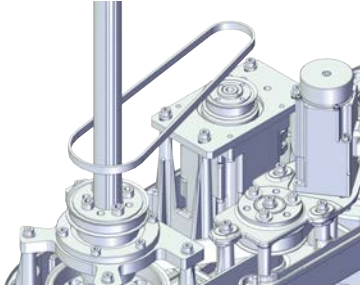

	Action	Note
1	<p>For robots with protection type Clean Room: Clean the joints that have been opened and wipe the parts free from particles with spirit on a lint free. See Cut the paint or surface on the robot before replacing parts on page 118</p> <p> Note</p> <p>After all repair work, wipe the Clean Room robot free from particles with spirit on a lint free cloth.</p>	
2	Refit the timing belt to the pulley on the ball screw and the motor. Ensure that the belt runs correctly in the grooves.	<p>Timing belt A3: 3HAC070464-001</p>  <p>xx2100001079</p>

Continues on next page

5 Repair

5.6.3 Replacing the pulley on the ball screw upper position

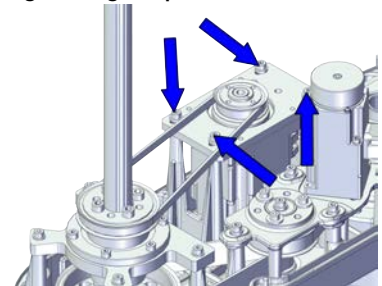
Continued

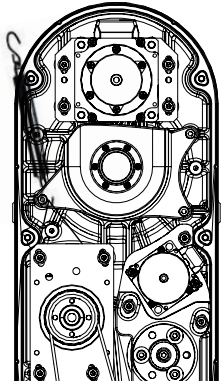
	Action	Note
3	Secure the screws and washers without fully tightened.	<p>Screws: Hex socket head cap screw M4x16 12.9 Lafre 2C2B/FC6.9 (4 pcs) Washers: Plain washer machining 4.2x9x2 steel (4 pcs) Tightening torque: 2.6 Nm \pm10%</p>  <p>xx2100001078</p>
4	Hang a strap to the hook on the motor.	
5	<p>Use a handheld dynamometer hooking to the strap and pull the dynamometer to make the tension falling in the allowed force range.</p> <p> Note</p> <p>During the measurement, make sure that all interferences that may affect the force are removed. Pay attention to the force application direction.</p>	<p>Used belt: 36.6 New belt:40</p>  <p>xx2100001126</p>
6	Use a sonic tension meter to measure the timing belt tension.	<p>Used belt: 139 New belt:110</p>
7	If the timing belt tension does not meet the requirement, loosen the motor screws and readjust.	



Refitting the cover of the outer arm

	Action	Note
1	<p>For robots with protection type Clean Room: Clean the joints that have been opened and wipe the parts free from particles with spirit on a lint free. See Cut the paint or surface on the robot before replacing parts on page 118</p> <p> Note</p> <p>After all repair work, wipe the Clean Room robot free from particles with spirit on a lint free cloth.</p>	

Continues on next page

5.6.3 Replacing the pulley on the ball screw upper position

Continued

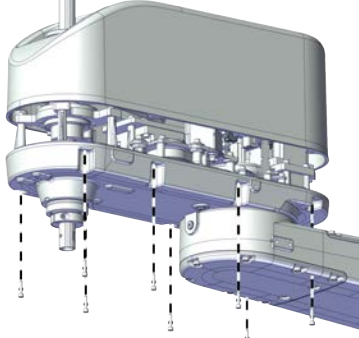
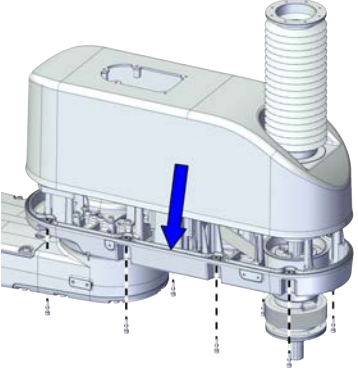
	Action	Note
2	<p>Refit the cover.</p> <p> Note</p> <p>For robots with protection class IP54 (option 3350-540)</p> <p>For robots with protection type Clean Room (option 3351-1)</p> <p>Refit the cover with bellow.</p> <p>Check the gasket for the outer arm cover.</p> <p> Tip</p> <p>Replace the gasket if needed.</p> <p> CAUTION</p> <p>The gasket is in the outer arm.</p>	<p>Screw: Hex socket head cap screw M4x16 12.9 Lafre 2C2B/FC6.9 (8 pcs)</p> <p>Tightening torque: 2 Nm ±10%</p> <p>For robots with protection class IP30 (option 3350-300)</p>  <p>xx210000933</p>
3	<p>Refit the screws.</p>	<p>For robots with protection class IP54 (option 3350-540)</p> <p>For robots with protection type Clean Room (option 3351-1)</p>  <p>xx2100002427</p>

For Clean Room/ IP54 robots

Refitting the top cover and the flange with bearing



	Action	Note
1	<p>For robots with protection type Clean Room:</p> <p>Clean the joints that have been opened and wipe the parts free from particles with spirit on a lint free. See Cut the paint or surface on the robot before replacing parts on page 118</p> <p> Note</p> <p>After all repair work, wipe the Clean Room robot free from particles with spirit on a lint free cloth.</p>	

Continues on next page

5 Repair

5.6.3 Replacing the pulley on the ball screw upper position

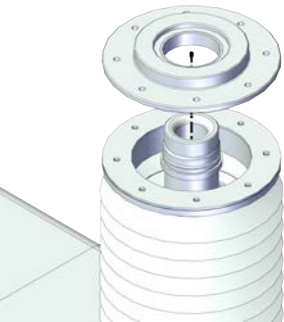
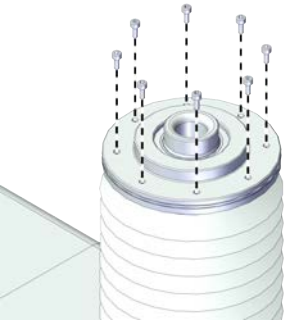
Continued

	Action	Note
2	<p>For robots with protection class IP54 (option 3350-540)</p> <p>For robots with protection type Clean Room (option 3351-1)</p> <p>Install the flange with bearing to the extension shaft.</p>	 <p>xx2100002402</p>
3	<p>For robots with protection class IP54 (option 3350-540)</p> <p>For robots with protection type Clean Room (option 3351-1)</p> <p>Refit the screws to the flange with bearing.</p>	<p>Screws: Hex socket head cap screw M2.5x6 12.9 Lafre 2C2B/FC6.9 (8 pcs)</p> <p>Tightening torque: 0.8 Nm \pm10%</p>  <p>xx2100002401</p>
4	<p>For robots with protection class IP54 (option 3350-540)</p> <p>For robots with protection type Clean Room (option 3351-1)</p> <p>Refit the top cover to the ball screw.</p> <p> Tip</p> <p>The top surface of the cover should be flush with the top end of the ball screw.</p>	 <p>xx2100002399</p>

Continues on next page

5.6.3 Replacing the pulley on the ball screw upper position

Continued

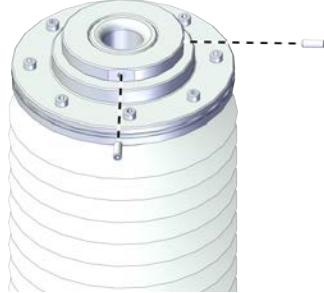
	Action	Note
5	<p>For robots with protection class IP54 (option 3350-540)</p> <p>For robots with protection type Clean Room (option 3351-1)</p> <p>Refit the locking screws.</p>	<p>Screws: Hexagon socket set screws with flat point, ISO 4026 stainless steel M3x8 (2 pcs)</p> <p>Tightening torque: 0.4 Nm \pm10%</p>  <p>xx2100002398</p>

Securing the process hub to outer arm cover



	Action	Note
1	<p>For robots with protection type Clean Room:</p> <p>Clean the joints that have been opened and wipe the parts free from particles with spirit on a lint free. See Cut the paint or surface on the robot before replacing parts on page 118</p> <p> Note</p> <p>After all repair work, wipe the Clean Room robot free from particles with spirit on a lint free cloth.</p>	
2	Insert the process hub from the outer arm cover.	

Continues on next page

5 Repair

5.6.3 Replacing the pulley on the ball screw upper position

Continued

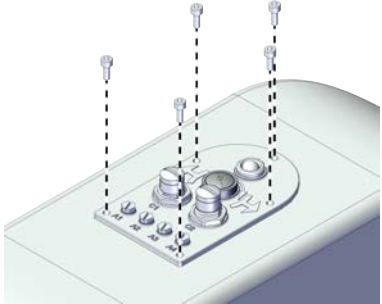
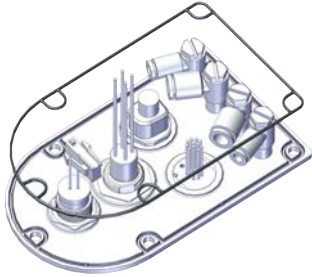
	Action	Note
3	<p>Secure the process hub to the outer arm cover with the screws.</p> <p> Note</p> <p>For robots with protection class IP54 (option 3350-540)</p> <p>For robots with protection type Clean Room (option 3351-1)</p> <p>Check the gasket for the process hub.</p> <p> Tip</p> <p>Replace the gasket if needed.</p> <p> CAUTION</p> <p>Be aware of the cabling that is attached to the cover! The cover can not be removed completely until the connectors are disconnected, as shown in following steps.</p>	<p>Screws: Hex socket head cap screw M4x10 12.9 Lafre 2C2B/FC6.9 (5 pcs)</p> <p>Tightening torque: 2.6 Nm±10%</p> <p>For robots with protection class IP30 (option 3350-300)</p>  <p>xx2100000932</p> <p>For robots with protection class IP54 (option 3350-540)</p> <p>For robots with protection type Clean Room (option 3351-1)</p>  <p>xx2100002438</p>

Concluding procedure

	Action	Note
1	<p>For robots with protection type Clean Room: Seal and paint the joints that have been opened. See Cut the paint or surface on the robot before replacing parts on page 118</p> <p> Note</p> <p>After all repair work, wipe the Clean Room robot free from particles with spirit on a lint free cloth.</p>	
2	Recalibrate the robot.	Calibration is detailed in section Calibration on page 945 .

Continues on next page

5.6.3 Replacing the pulley on the ball screw upper position

Continued

	Action	Note
3	 DANGER Make sure all safety requirements are met when performing the first test run.	

5 Repair

5.6.4 Replacing the pulley on the ball screw lower position

5.6.4 Replacing the pulley on the ball screw lower position

Location of the pulley

The pulley is located as shown in the figure.

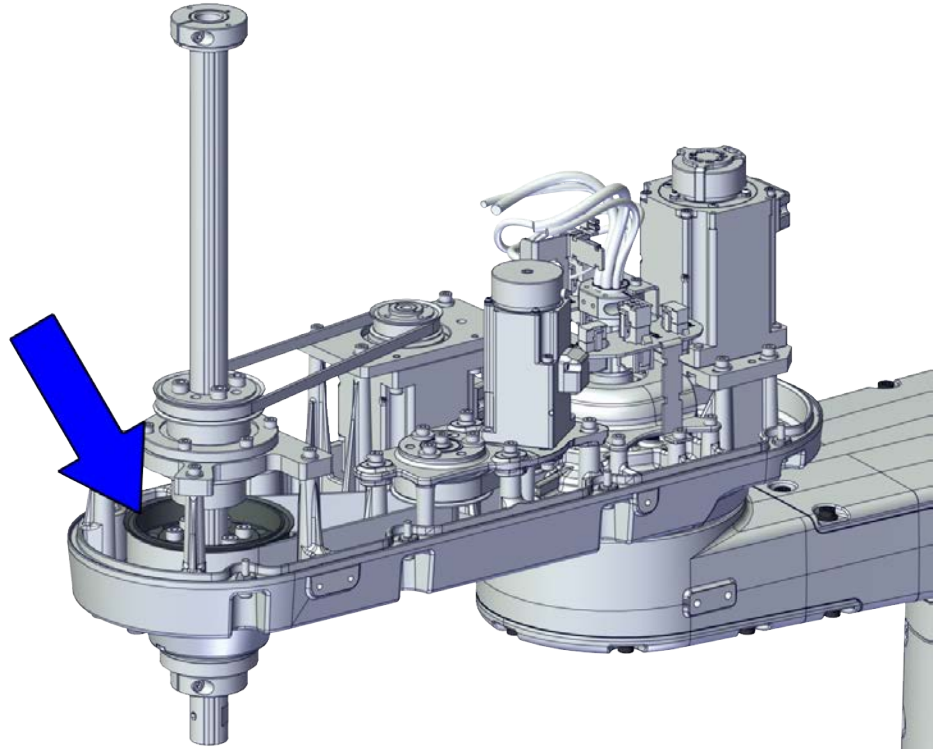

xx2100001017

Required spare parts



Note

The spare part numbers that are listed in the table can be out of date. See the latest spare parts of the IRB 920 via myABB Business Portal, www.abb.com/myABB.

Spare part	Article number	Note
Ax4-2 pulley Z2, 2020A	3HAC070481-001	
Mechanical-Stop bottom, D20	3HAC073069-001	With bolt
Outer arm cover	3HAC076611-001	

Required tools and equipment

Equipment	Article number	Note
Standard toolkit	-	Content is defined in section Standard toolkit on page 996 .
IRB 920 special tool	3HAC077249-001	Used to install the ball screw nut. Special tool for L2

Continues on next page

5.6.4 Replacing the pulley on the ball screw lower position

Continued

Equipment	Article number	Note
Calibration toolbox, Axis Calibration	3HAC055412-001	Delivered as a set of calibration tools. Required if Axis Calibration is the valid calibration method for the robot.
24 VDC power supply	-	Used to release the motor brakes.
Sonic tension meter	-	Used for measuring the timing belt tension.
Handheld dynamometer	-	Used for measuring the timing belt tension.

Required consumables

Consumable	Article number	Note
Cable straps	-	
Grease	-	THK AFA

Deciding calibration routine

Decide which calibration routine to be used, based on the information in the table. Depending on which routine is chosen, action might be required prior to beginning the repair work of the robot, see the table.

	Action	Note
1	Decide which calibration routine to use for calibrating the robot. <ul style="list-style-type: none"> Reference calibration. External cable packages (DressPack) and tools can stay fitted on the robot. Fine calibration. All external cable packages (DressPack) and tools must be removed from the robot. 	
	If the robot is to be calibrated with reference calibration: Find previous reference values for the axis or create new reference values. These values are to be used after the repair procedure is completed, for calibration of the robot. If no previous reference values exist, and no new reference values can be created, then reference calibration is not possible.	Follow the instructions given in the reference calibration routine on the FlexPendant to create reference values. Creating new values requires possibility to move the robot. Read more about reference calibration for Axis Calibration in Reference calibration routine on page 957 .
	If the robot is to be calibrated with fine calibration: Remove all external cable packages (DressPack) and tools from the robot.	

Continues on next page

5 Repair

5.6.4 Replacing the pulley on the ball screw lower position



Continued

Removing the pulley on the ball screw lower position

Use these procedures to remove the pulley.



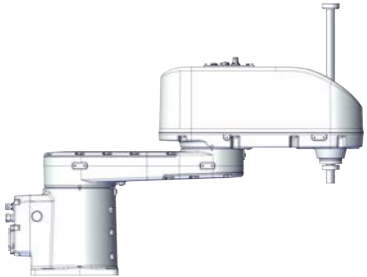

Preparations before removing the pulley

Remove the robot from the wall.

	Action	Note
1	Decide which calibration routine to use, and take actions accordingly prior to beginning the repair procedure.	
2	<p>If there is no enough space for the maintenance work, remove the robot from the wall and place it on the maintenance bracket.</p> <p> CAUTION</p> <p>Do not lay down the robot during the transportation, always keep it straight. If the robot lay down in any situation, the grease may come out from gearbox.</p>	
3	Jog all axes to zero position.	 xx2100000930
4	<p> DANGER</p> <p>Turn off all:</p> <ul style="list-style-type: none">• electric power supply• hydraulic pressure supply• air pressure supply <p>to the robot, before entering the safeguarded space.</p>	
5	<p> CAUTION</p> <p>For robots with protection type Clean Room Always cut the paint with a knife and grind the paint edge when disassembling parts of the robot! See Cut the paint or surface on the robot before replacing parts on page 118.</p>	

Continues on next page

Removing the process hub screws

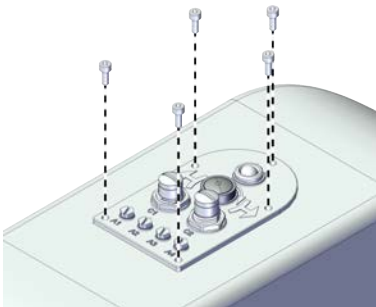
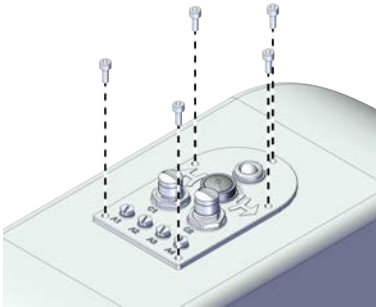
	Action	Note
1	 DANGER Make sure that all supplies for electrical power, hydraulic pressure, and air pressure are turned off.	
2	 CAUTION For robots with protection type Clean Room Always cut the paint with a knife and grind the paint edge when disassembling parts of the robot! See Cut the paint or surface on the robot before replacing parts on page 118 .	
3	Remove the screws on the process hub.  Note For robots with protection class IP54 (option 3350-540) For robots with protection type Clean Room (option 3351-1) Remove the screws on the process hub and take out the gasket.  Tip Check the gasket and replace it if needed.	For robots with protection class IP30  xx2100000932 For robots with protection class IP54 (option 3350-540) For robots with protection type Clean Room (option 3351-1)  xx2100000932
4	Insert the process hub to the outer arm.	

Continues on next page





5 Repair

5.6.4 Replacing the pulley on the ball screw lower position

Continued

For Clean Room/ IP54 robots

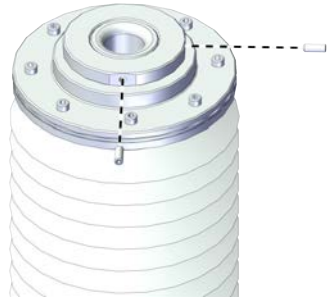
Removing the top cover and the flange with bearing

	Action	Note
1	 DANGER Make sure that all supplies for electrical power, hydraulic pressure, and air pressure are turned off.	
2	 CAUTION For robots with protection type Clean Room Always cut the paint with a knife and grind the paint edge when disassembling parts of the robot! See Cut the paint or surface on the robot before replacing parts on page 118 .	
3	For robots with protection class IP54 (option 3350-540) For robots with protection type Clean Room (option 3351-1) Loose the locking screws.	 xx2100002398
4	For robots with protection class IP54 (option 3350-540) For robots with protection type Clean Room (option 3351-1) Remove the top cover from the ball screw.	 xx2100002399



Continues on next page

5.6.4 Replacing the pulley on the ball screw lower position

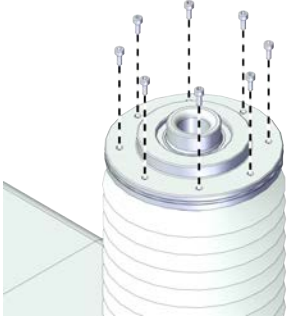
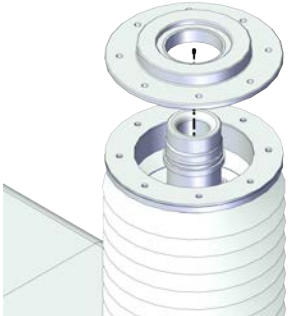
Continued

	Action	Note
5	<p>For robots with protection class IP54 (option 3350-540) For robots with protection type Clean Room (option 3351-1) Remove the screws on the flange with bearing.</p>	 <p>xx2100002401</p>
6	<p>For robots with protection class IP54 (option 3350-540) For robots with protection type Clean Room (option 3351-1) Remove the flange with bearing.</p>	 <p>xx2100002402</p>

Removing the cover of the outer arm



	Action	Note
1	<p> DANGER</p> <p>Make sure that all supplies for electrical power, hydraulic pressure, and air pressure are turned off.</p>	
2	<p> CAUTION</p> <p>For robots with protection type Clean Room Always cut the paint with a knife and grind the paint edge when disassembling parts of the robot! See Cut the paint or surface on the robot before replacing parts on page 118.</p>	

Continues on next page

5 Repair

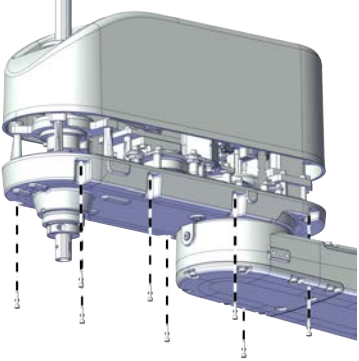
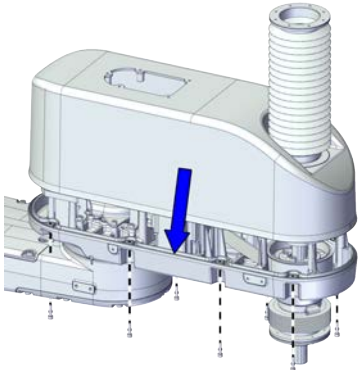

5.6.4 Replacing the pulley on the ball screw lower position

Continued

	Action	Note
3	<p>Remove the screws on the cover of the outer arm and remove the cover.</p> <p> Note</p> <p>For robots with protection class IP54 (option 3350-540) For robots with protection type Clean Room (option 3351-1) Remove the cover with bellow and housing.</p> <p> Note</p> <p>The bellow does not need to be removed separately.</p> <p> Tip</p> <p>Check the gasket and replace it if needed.</p>	<p>For robots with protection class IP30</p>  <p>xx210000933</p> <p>For robots with protection class IP54 (option 3350-540) For robots with protection type Clean Room (option 3351-1)</p>  <p>xx2100002427</p>

For Clean Room/ IP54 robots

Removing the lower cover and the flange with bearing

	Action	Note
1	<p> DANGER</p> <p>Make sure that all supplies for electrical power, hydraulic pressure, and air pressure are turned off.</p>	
2	<p> CAUTION</p> <p>For robots with protection type Clean Room Always cut the paint with a knife and grind the paint edge when disassembling parts of the robot! See Cut the paint or surface on the robot before replacing parts on page 118.</p>	

Continues on next page

5.6.4 Replacing the pulley on the ball screw lower position

Continued

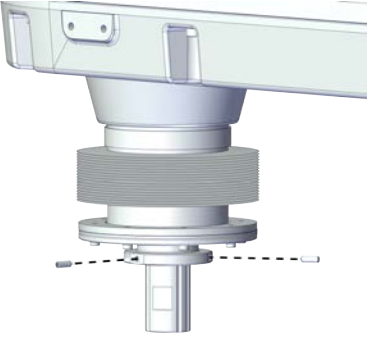
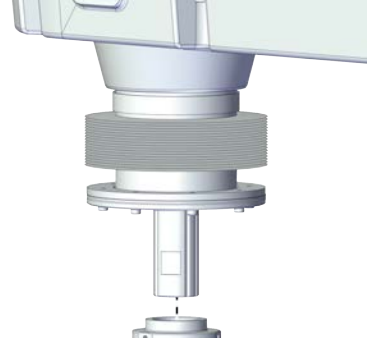
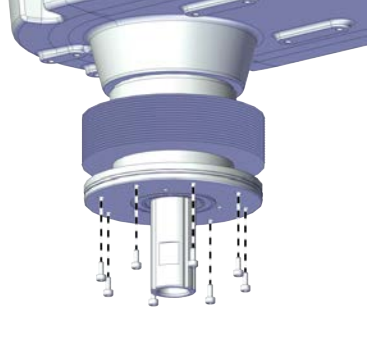
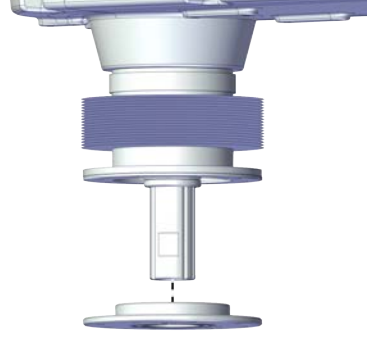
	Action	Note
3	<p>For robots with protection class IP54 (option 3350-540) For robots with protection type Clean Room (option 3351-1) Loose the locking screws.</p>	 <p>xx2100002404</p>
4	<p>For robots with protection class IP54 (option 3350-540) For robots with protection type Clean Room (option 3351-1) Remove the lower cover from the ball screw.</p>	 <p>xx2100002405</p>
5	<p>For robots with protection class IP54 (option 3350-540) For robots with protection type Clean Room (option 3351-1) Remove the screws on the flange with bearing.</p>	 <p>xx2100002406</p>
6	<p>For robots with protection class IP54 (option 3350-540) For robots with protection type Clean Room (option 3351-1) Remove the flange with bearing.</p>	 <p>xx2100002407</p>







Continues on next page

5 Repair

5.6.4 Replacing the pulley on the ball screw lower position

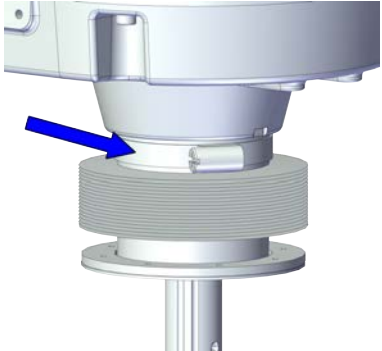



Continued

Removing the lower bellow

	Action	Note
1	 DANGER Make sure that all supplies for electrical power, hydraulic pressure, and air pressure are turned off.	
2	 CAUTION For robots with protection type Clean Room Always cut the paint with a knife and grind the paint edge when disassembling parts of the robot! See Cut the paint or surface on the robot before replacing parts on page 118 .	
3	For robots with protection class IP54 (option 3350-540) For robots with protection type Clean Room (option 3351-1) Loosen the upper bellow clamp by loosening the screw and pull the clamp apart slightly.	 xx2100002408
4	For robots with protection class IP54 (option 3350-540) For robots with protection type Clean Room (option 3351-1) Remove the bellow from the outer arm.  Note For robots with protection class IP54 (option 3350-540) Clean the bellow from the glue if it will be reused.	
5	For robots with protection class IP54 (option 3350-540) Remove the bellow gasket from the bellow.  Note Clean the bellow gasket from the glue if it will be reused.  Note Be careful when removing the bellow gaskets. If any broken, replace it.	

Continues on next page

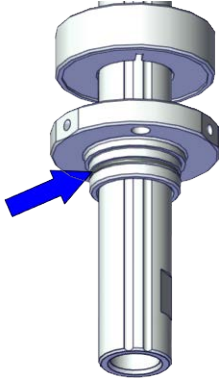
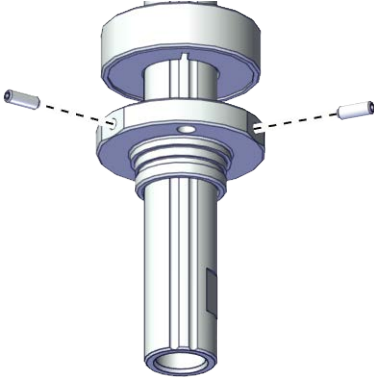
Removing the shaft for Clean Room/ IP54 robots

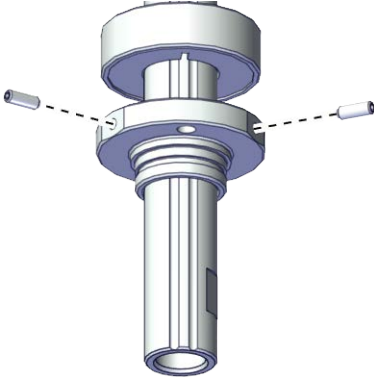
	Action	Note
1	 <p>DANGER</p> <p>Make sure that all supplies for electrical power, hydraulic pressure, and air pressure are turned off.</p>	
2	 <p>CAUTION</p> <p>For robots with protection type Clean Room Always cut the paint with a knife and grind the paint edge when disassembling parts of the robot! See <i>Cut the paint or surface on the robot before replacing parts on page 118.</i></p>	
3	<p>For robots with protection class IP54 (option 3350-540) For robots with protection type Clean Room (option 3351-1) Remove the O-ring from the lower housing.</p>	 <p>xx1900001615</p>
4	<p>For robots with protection class IP54 (option 3350-540) For robots with protection type Clean Room (option 3351-1) Loose the attachment screws.</p>	
5	<p>For robots with protection class IP54 (option 3350-540) For robots with protection type Clean Room (option 3351-1) Remove the shaft from the mechanical stopper.</p> <p> Note</p> <p>The shaft is glued to the ball screw. Be careful with the glue when removing the shaft.</p>	 <p>xx1900001616</p>



Continues on next page

5 Repair

5.6.4 Replacing the pulley on the ball screw lower position

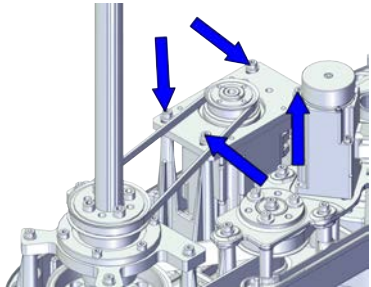
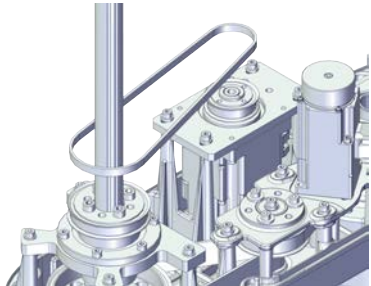

Continued

Removing the axis-3 timing belt

	Action	Note
1	 DANGER Make sure that all supplies for electrical power, hydraulic pressure, and air pressure are turned off.	
2	 CAUTION For robots with protection type Clean Room Always cut the paint with a knife and grind the paint edge when disassembling parts of the robot! See Cut the paint or surface on the robot before replacing parts on page 118 .	
3	 DANGER Make sure that the ball screw is supported with something. The sudden drop of the ball screw due the lost of the axis-3 motor may cause danger.	
4	Loosen the screws of the axis-3 motor sub-assembly to let the axis-3 timing belt free.	 xx2100001078
5	Remove the timing belt.	 xx2100001079

Continues on next page

Removing the lower mechanical stopper

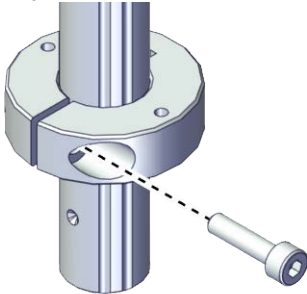
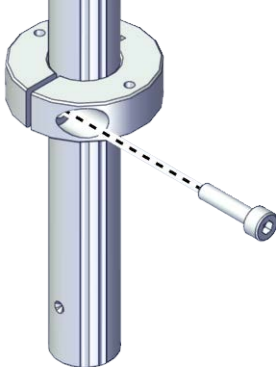
	Action	Note
1	 <p>DANGER</p> <p>Make sure that all supplies for electrical power, hydraulic pressure, and air pressure are turned off.</p>	
2	 <p>CAUTION</p> <p>For robots with protection type Clean Room Always cut the paint with a knife and grind the paint edge when disassembling parts of the robot! See Cut the paint or surface on the robot before replacing parts on page 118.</p>	
3	Remove the screw.	<p>For robots with protection class IP30 (option 3350-300)</p>  <p>xx1800002860</p> <p>For robots with protection class IP54 (option 3350-540) For robots with protection type Clean Room (option 3351-1)</p>  <p>xx1900001642</p>

Continues on next page



5 Repair

5.6.4 Replacing the pulley on the ball screw lower position

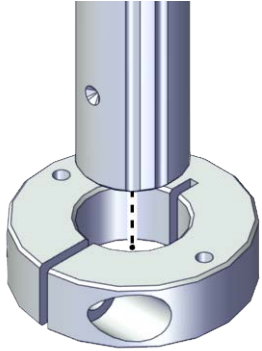
Continued

	Action	Note
4	<p>Remove the mechanical stopper.</p> <p> CAUTION</p> <p>If the ball screw nut or ball screw spline nut go out of the screw shaft, the ball screw is destroyed. Be careful when you do any work that may cause this.</p>	 <p>xx1800002861</p>



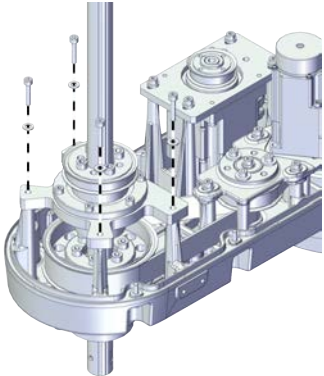

Removing the ball screw with the flange

	Action	Note
1	<p> DANGER</p> <p>Make sure that all supplies for electrical power, hydraulic pressure, and air pressure are turned off.</p>	
2	<p> ELECTROSTATIC DISCHARGE (ESD)</p> <p>The unit is sensitive to ESD. Before handling the unit read the safety information in section The unit is sensitive to ESD on page 49.</p>	
3	<p> CAUTION</p> <p>For robots with protection type Clean Room</p> <p>Always cut the paint with a knife and grind the paint edge when disassembling parts of the robot! See Cut the paint or surface on the robot before replacing parts on page 118.</p>	
4	<p>Remove the screws and washers on the ball screw flange.</p>	 <p>xx2100001082</p>

Continues on next page

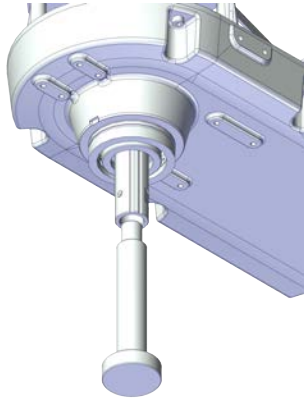
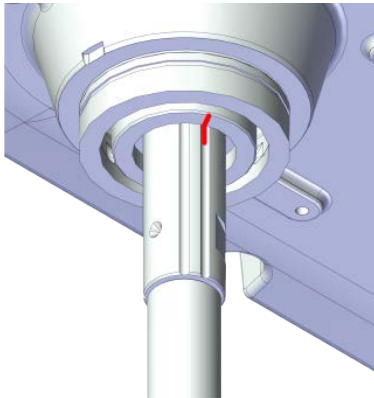
5.6.4 Replacing the pulley on the ball screw lower position

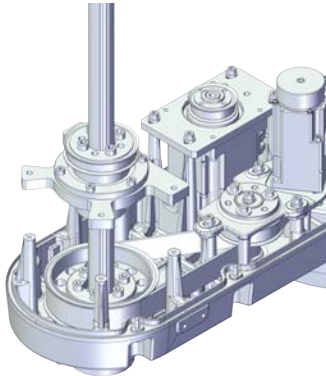
Continued

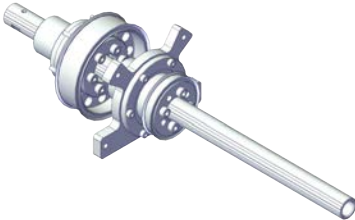
	Action	Note
5	Insert the special tool into the ball screw shaft.	IRB 920 special tool:3HAC077249-001  xx2100001129
6	Mark the location of the ball screw shaft grooves on the ball screw lower nut.	 xx2100001187
7	Take out the ball screw with the flange assembly carefully.  CAUTION Move the special tool along with the ball screw shaft until it is totally inserted into the lower nut of the ball screw and keep the status. When the special tool is totally inserted to the lower nut of the ball screw, support the special tool with some thing. Or the ball screw lower nut will be destroyed.	 xx2100001083
8	Lay down the ball screw assembly.  CAUTION If the ball screw nut or ball screw spline nut go out of the screw shaft, the ball screw is destroyed. Be careful when you do any work that may cause this.	 xx2100001084



Continues on next page

5 Repair



5.6.4 Replacing the pulley on the ball screw lower position

Continued

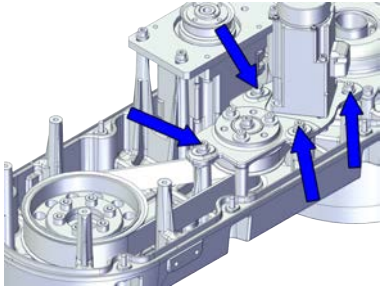
Loosening the transmission module screws

	Action	Note
1	 DANGER Make sure that all supplies for electrical power, hydraulic pressure, and air pressure are turned off.	
2	 CAUTION For robots with protection type Clean Room Always cut the paint with a knife and grind the paint edge when disassembling parts of the robot! See Cut the paint or surface on the robot before replacing parts on page 118 .	
3	 DANGER Make sure that the ball screw is supported with something. The sudden drop of the ball screw due the lost of the axis-3 motor may cause danger.	
4	Loosen the screws of the transmission module to let the axis-4-2 timing belt free.	 xx2100001081



Removing the pulley on the ball screw lower position

	Action	Note
1	 DANGER Make sure that all supplies for electrical power, hydraulic pressure, and air pressure are turned off.	
2	 ELECTROSTATIC DISCHARGE (ESD) The unit is sensitive to ESD. Before handling the unit read the safety information in section The unit is sensitive to ESD on page 49 .	

Continues on next page

5.6.4 Replacing the pulley on the ball screw lower position

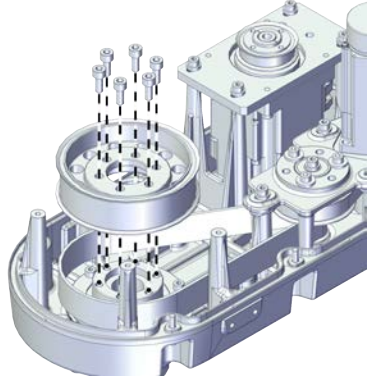

Continued

	Action	Note
3	<p> CAUTION</p> <p>For robots with protection type Clean Room Always cut the paint with a knife and grind the paint edge when disassembling parts of the robot! See Cut the paint or surface on the robot before replacing parts on page 118.</p>	
4	Remove the screws and washers.	 <p>xx2100001085</p>
5	<p>Remove the pulley carefully.</p> <p> CAUTION</p> <p>If the ball screw nut or ball screw spline nut go out of the screw shaft, the ball screw is destroyed. Be careful when you do any work that may cause this.</p>	

Refitting the pulley on the ball screw lower position

Use these procedures to refit the pulley.

Refitting the pulley on the ball screw lower position



	Action	Note
1	<p> ELECTROSTATIC DISCHARGE (ESD)</p> <p>The unit is sensitive to ESD. Before handling the unit read the safety information in section The unit is sensitive to ESD on page 49.</p>	
2	<p>For robots with protection type Clean Room: Clean the joints that have been opened and wipe the parts free from particles with spirit on a lint free. See Cut the paint or surface on the robot before replacing parts on page 118</p> <p> Note</p> <p>After all repair work, wipe the Clean Room robot free from particles with spirit on a lint free cloth.</p>	

Continues on next page

5 Repair

5.6.4 Replacing the pulley on the ball screw lower position

Continued

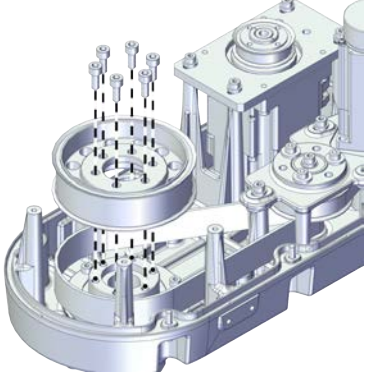
	Action	Note
3	<p>Refit the pulley to the ball screw carefully.</p> <p> CAUTION</p> <p>If the ball screw nut or ball screw spline nut go out of the screw shaft, the ball screw is destroyed. Be careful when you do any work that may cause this.</p>	<p>Screws: Hex socket head cap screw M5x12 12.9 Lafre 2C2B/FC6.9 (6 pcs)</p> <p>Washers: Spring washer 9x4.3x1 Steel (6 pcs)</p> <p>Tightening torque: 4.4 Nm \pm10%</p>
4	<p>Refit the screws.</p> <p> Tip</p> <p>Secure with the stopping tool to prevent the pulley from rotating.</p>	 <p>xx2100001085</p>

Refitting the axis-4 second timing belt to the pulley

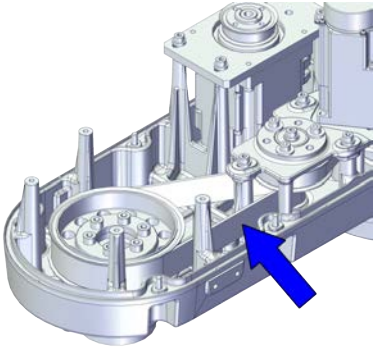



	Action	Note
1	<p>For robots with protection type Clean Room: Clean the joints that have been opened and wipe the parts free from particles with spirit on a lint free. See Cut the paint or surface on the robot before replacing parts on page 118</p> <p> Note</p> <p>After all repair work, wipe the Clean Room robot free from particles with spirit on a lint free cloth.</p>	
2	<p>Refit the belt to the pulley. Ensure that the belt runs correctly in the grooves.</p>	<p>Timing belt, A4-2: 3HAC070471-001</p>  <p>xx2100001086</p>

Continues on next page

5.6.4 Replacing the pulley on the ball screw lower position

Continued

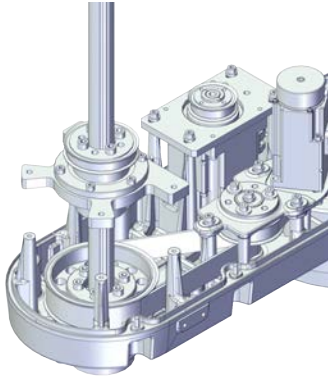
Refitting the ball screw with the flange

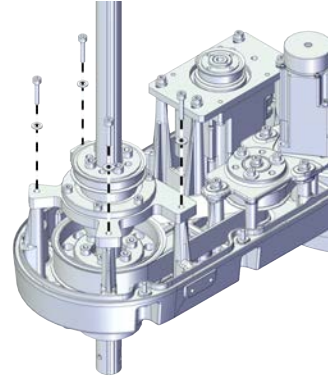
	Action	Note
1	<p>For robots with protection type Clean Room: Clean the joints that have been opened and wipe the parts free from particles with spirit on a lint free. See Cut the paint or surface on the robot before replacing parts on page 118</p> <p> Note</p> <p>After all repair work, wipe the Clean Room robot free from particles with spirit on a lint free cloth.</p>	
2	<p>Refit the ball screw assembly to the outer arm.</p> <p> Tip</p> <p>Make sure the marked location is aligned with the ball screw shaft grooves.</p> <p> CAUTION</p> <p>With the inserting of the ball screw shaft, remove the special tool along with the ball screw shaft carefully.</p>	<p>IRB 920 special tool:3HAC077249-001</p>  <p>xx2100001083</p>
3	<p>Refit the screws and washers to the secure the ball screw flange to the outer arm.</p> <p> Tip</p> <p>Pre-tighten the screws at 0.5Nm and slide the ball screw up and down for five times. Then tighten the screws at 3.8Nm to secure it.</p>	<p>Screws: Hex socket head cap screw M4x20 12.9 Lafre 2C2B/FC6.9 (4 pcs) Washers: Spring washer 9x4.3x1 Steel (4 pcs) Tightening torque: 3.5 Nm ±10%</p>  <p>xx2100001082</p>

Continues on next page

5 Repair

5.6.4 Replacing the pulley on the ball screw lower position

Continued





Refitting the mechanical stopper

	Action	Note
1	<p>For robots with protection type Clean Room: Clean the joints that have been opened and wipe the parts free from particles with spirit on a lint free. See Cut the paint or surface on the robot before replacing parts on page 118</p> <p> Note</p> <p>After all repair work, wipe the Clean Room robot free from particles with spirit on a lint free cloth.</p>	

Continues on next page

5.6.4 Replacing the pulley on the ball screw lower position

Continued

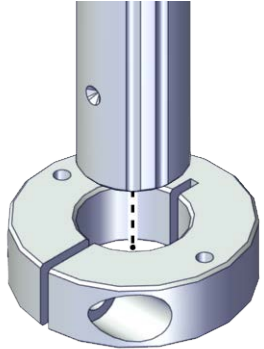
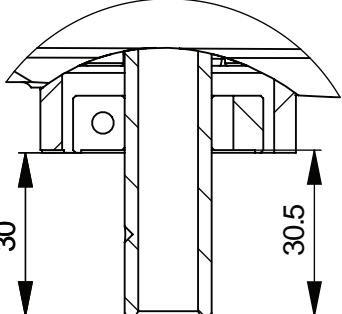
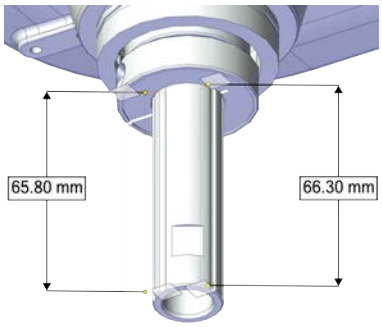
	Action	Note
2	<p>Refit the mechanical stopper to the ball screw at 30.5 mm position to the lower of the ball screw.</p> <p> Note</p> <p>For robots with protection class IP54 (option 3350-540) For robots with protection type Clean Room (option 3351-1) For 180 mm ball screw, refit the mechanical stopper to the ball screw at 65.8 mm position to the lower of the ball screw. For 300 mm ball screw, refit the mechanical stopper to the ball screw at 80.8 mm position to the lower of the ball screw.</p> <p> Tip</p> <p>Make sure that the limit block opening gap is aligned with the ball screw origin point.</p> <p> CAUTION</p> <p>If the ball screw nut or ball screw spline nut go out of the screw shaft, the ball screw is destroyed. Be careful when you do any work that may cause this.</p> <p> Note</p> <p>Be careful with the orientation of the mechanical stopper. The flat side is on the upper side.</p>	 <p>xx1800002861</p> <p>For robots with protection class IP30 (option 3350-300)</p>  <p>xx1900000144</p> <p>For robots with protection class IP54 (option 3350-540) For robots with protection type Clean Room (option 3351-1) For 180 mm ball screw</p>  <p>xx2100002425</p> <p>For 300 mm ball screw</p>

Continues on next page

5 Repair

5.6.4 Replacing the pulley on the ball screw lower position

Continued

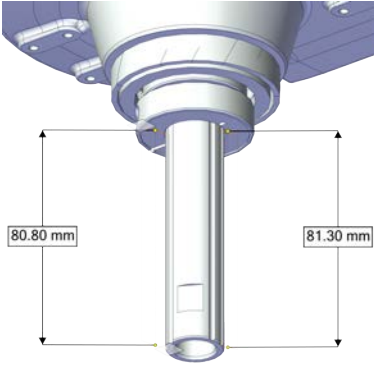
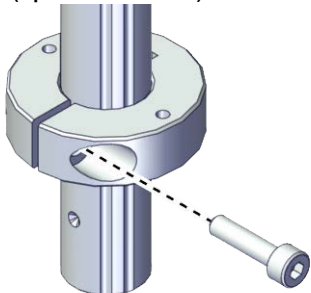
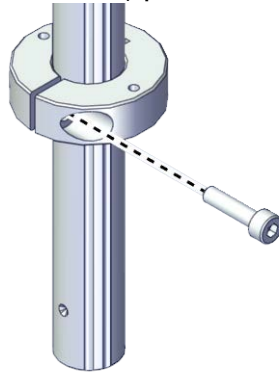
	Action	Note
		 <p>xx2100002426</p>
3	Refit the screw.	<p>Screws: Hex socket head cap screw M4x16 12.9 Lafre 2C2B/FC6.9 (1 pcs) Tightening torque: 6.5 Nm For robots with protection class IP30 (option 3350-300)</p>  <p>xx1800002860</p> <p>For robots with protection class IP54 (option 3350-540) For robots with protection type Clean Room (option 3351-1)</p>  <p>xx1900001642</p>

Continues on next page

5.6.4 Replacing the pulley on the ball screw lower position

Continued

Refitting the axis-3 timing belt

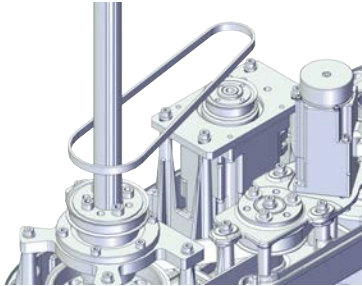
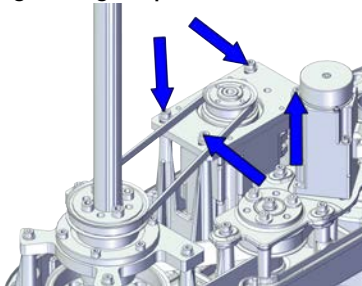
	Action	Note
1	<p>For robots with protection type Clean Room: Clean the joints that have been opened and wipe the parts free from particles with spirit on a lint free. See Cut the paint or surface on the robot before replacing parts on page 118</p> <p> Note</p> <p>After all repair work, wipe the Clean Room robot free from particles with spirit on a lint free cloth.</p>	
2	<p>Refit the timing belt to the pulley on the ball screw and the motor. Ensure that the belt runs correctly in the grooves.</p>	<p>Timing belt A3: 3HAC070464-001</p>  <p>xx2100001079</p>
3	<p>Secure the screws and washers without fully tightened.</p>	<p>Screws: Hex socket head cap screw M4x16 12.9 Lafre 2C2B/FC6.9 (4 pcs) Washers: Plain washer machining 4.2x9x2 steel (4 pcs) Tightening torque: 2.6 Nm ±10%</p>  <p>xx2100001078</p>
4	<p>Hang a strap to the hook on the motor.</p>	

Continues on next page



5 Repair

5.6.4 Replacing the pulley on the ball screw lower position

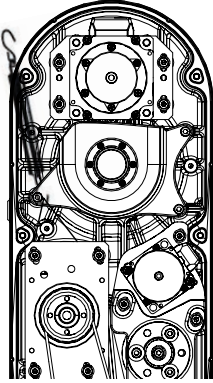
Continued

	Action	Note
5	<p>Use a handheld dynamometer hooking to the strap and pull the dynamometer to make the tension falling in the allowed force range.</p> <p> Note</p> <p>During the measurement, make sure that all interferences that may affect the force are removed. Pay attention to the force application direction.</p>	<p>Used belt: 36.6 New belt:40</p>  <p>xx2100001126</p>
6	Use a sonic tension meter to measure the timing belt tension.	Used belt: 139 New belt:110
7	If the timing belt tension does not meet the requirement, loosen the motor screws and readjust.	



Fastening the transmission module screws and tension axis-4-2 timing belt

	Action	Note
1	<p> DANGER</p> <p>Make sure that all supplies for electrical power, hydraulic pressure, and air pressure are turned off.</p>	
2	<p> CAUTION</p> <p>For robots with protection type Clean Room Always cut the paint with a knife and grind the paint edge when disassembling parts of the robot! See Cut the paint or surface on the robot before replacing parts on page 118.</p>	
3	<p> DANGER</p> <p>Make sure that the ball screw is supported with something. The sudden drop of the ball screw due the lost of the axis-3 motor may cause danger.</p>	

Continues on next page

5.6.4 Replacing the pulley on the ball screw lower position

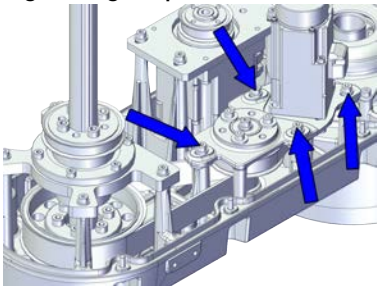
Continued

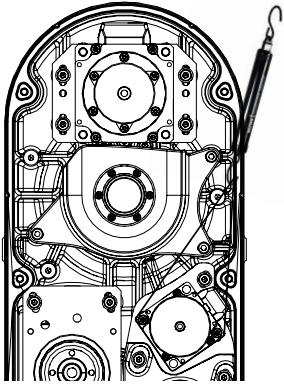
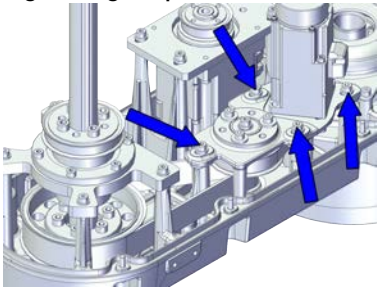
	Action	Note
4	Refit the screws of the transmission module without fully tightened.	<p>Screws: Hex socket head cap screw M4x20 12.9 Lafre 2C2B/FC6.9 (4 pcs) Washers: Plain washer machining 4.2x9x2 steel (4 pcs) Tightening torque: 2.6 Nm ±10%</p>  <p>xx2100001087</p>
5	Hang a strong strap to the motor.	
6	<p>Use a handheld dynamometer hooking to the strap and pull the dynamometer to make the tension falling in the allowed force range.</p> <p> Note</p> <p>During the measurement, make sure that all interferences that may affect the force are removed. Pay attention to the force application direction.</p>	<p>Used belt: 100 New belt:240</p>  <p>xx2100001127</p>
7	Fasten the screws to the recommended tightening torque.	<p>Tightening torque: 2.6 Nm ±10%</p>  <p>xx2100001087</p>
8	Use a sonic tension meter to measure the timing belt tension.	<p>Used belt: 202 New belt:180</p>
9	If the timing belt tension does not meet the requirement, loosen the motor screws and readjust.	

Continues on next page

5 Repair

5.6.4 Replacing the pulley on the ball screw lower position

Continued

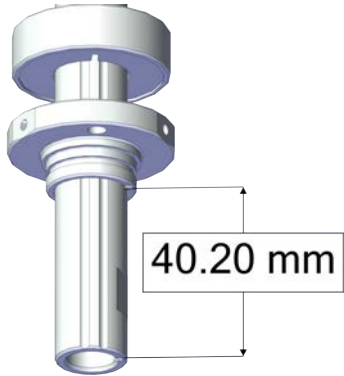
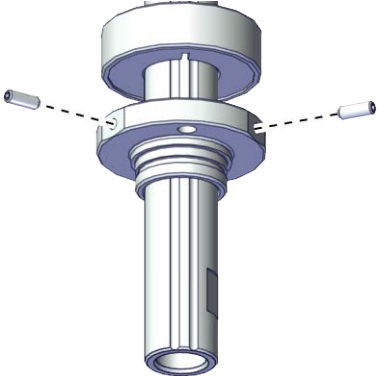

For Clean Room/ IP54 robots

Refitting the shaft for Clean Room/ IP54 robots

	Action	Note
1	<p>For robots with protection type Clean Room: Clean the joints that have been opened and wipe the parts free from particles with spirit on a lint free. See Cut the paint or surface on the robot before replacing parts on page 118</p> <p> Note</p> <p>After all repair work, wipe the Clean Room robot free from particles with spirit on a lint free cloth.</p>	
2	<p>For robots with protection class IP54 (option 3350-540) For robots with protection type Clean Room (option 3351-1) Install the shaft to the ball screw at 40.2 mm position to the lower of the ball screw.</p>	 <p>xx1900001617</p>
3	<p>For robots with protection class IP54 (option 3350-540) For robots with protection type Clean Room (option 3351-1) Secure the shaft to the ball screw with the screws.</p>	<p>Screws: Hexagon socket set screws with flat point, ISO 4026 stainless steel M3x8 (2 pcs) Tightening torque: 0.4 Nm ±10%</p>  <p>xx1900001616</p>

Continues on next page

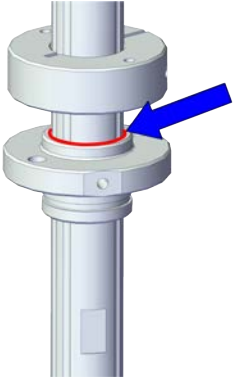
5.6.4 Replacing the pulley on the ball screw lower position
Continued

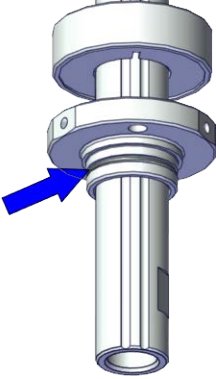
	Action	Note
4	<p>For robots with protection class IP54 (option 3350-540)</p> <p>Apply the glue to the upper contacted zone between the shaft and the ball screw.</p> <p> Note</p> <p>Fulfill the gaps on the ball screw in this contacted zone to make a sealing structure.</p>	 <p>xx1900001805</p>
5	<p>For robots with protection class IP54 (option 3350-540)</p> <p>For robots with protection type Clean Room (option 3351-1)</p> <p>Insert the O-ring to the shaft.</p> <p> Note</p> <p>Replace the o-ring if needed.</p>	 <p>xx1900001615</p>

Refitting the lower bellow to outer arm

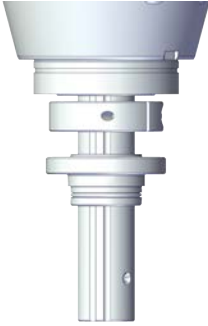

	Action	Note
1	<p>For robots with protection type Clean Room:</p> <p>Clean the joints that have been opened and wipe the parts free from particles with spirit on a lint free. See Cut the paint or surface on the robot before replacing parts on page 118</p> <p> Note</p> <p>After all repair work, wipe the Clean Room robot free from particles with spirit on a lint free cloth.</p>	
2	<p>For robots with protection class IP54 (option 3350-540)</p> <p>Apply the glue to the outer arm.</p>	 <p>xx2100002409</p>

Continues on next page

5 Repair

5.6.4 Replacing the pulley on the ball screw lower position

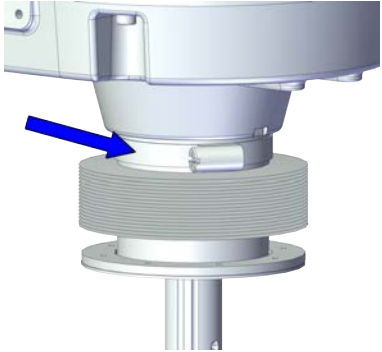
Continued

	Action	Note
3	<p>For robots with protection class IP54 (option 3350-540)</p> <p>For robots with protection type Clean Room (option 3351-1)</p> <p>Install the bellow to the shaft.</p>	
4	<p>For robots with protection class IP54 (option 3350-540)</p> <p>For robots with protection type Clean Room (option 3351-1)</p> <p>Pull the upper end of the bellow to the outer arm.</p> <p> Tip</p> <p>For robots with protection class IP54 (option 3350-540)</p> <p>Hold the bellow for a little while until it's attached to the housing.</p>	<p>Tightening torque: 2.5 Nm \pm10%</p> 
5	<p>For robots with protection class IP54 (option 3350-540)</p> <p>Install the bellow gaskets to the bellow.</p> <p> Tip</p> <p>The angle between the gap on the bellow gasket and gap on the inner bellow gasket should be 90 degrees.</p>	xx2100002408
6	<p>For robots with protection class IP54 (option 3350-540)</p> <p>For robots with protection type Clean Room (option 3351-1)</p> <p>Secure them with the clamp.</p> <p> Tip</p> <p>The opening part of the clamp should be in the opposite position to the gap on the bellow gasket.</p>	

Refitting the lower cover and the flange with bearing

	Action	Note
1	<p>For robots with protection type Clean Room:</p> <p>Clean the joints that have been opened and wipe the parts free from particles with spirit on a lint free. See Cut the paint or surface on the robot before replacing parts on page 118</p> <p> Note</p> <p>After all repair work, wipe the Clean Room robot free from particles with spirit on a lint free cloth.</p>	

Continues on next page

5.6.4 Replacing the pulley on the ball screw lower position

Continued

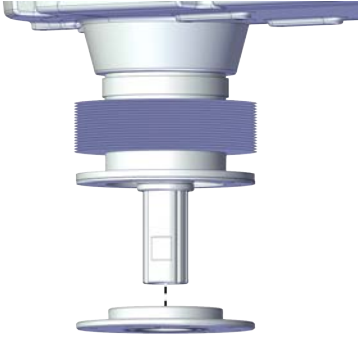
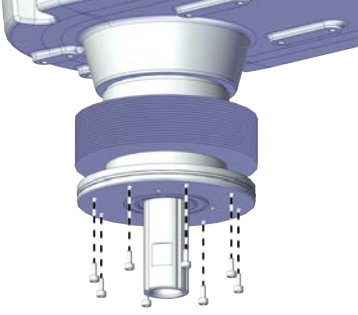
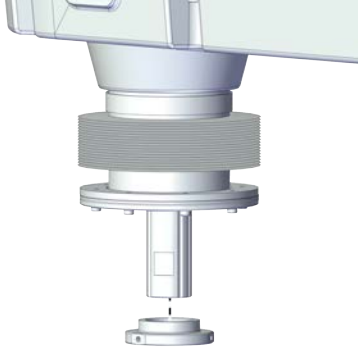
	Action	Note
2	<p>For robots with protection class IP54 (option 3350-540) For robots with protection type Clean Room (option 3351-1) Install the flange with bearing to the shaft.</p>	 <p>xx2100002407</p>
3	<p>For robots with protection class IP54 (option 3350-540) For robots with protection type Clean Room (option 3351-1) Refit the screws to the flange with bearing.</p>	<p>Screws: Hex socket head cap screw M2.5x6 12.9 Lafre 2C2B/FC6.9 (8 pcs) Tightening torque: 0.8 Nm ±10%</p>  <p>xx2100002406</p>
4	<p>For robots with protection class IP54 (option 3350-540) For robots with protection type Clean Room (option 3351-1) Refit the lower cover to the ball screw.</p>	 <p>xx2100002405</p>

Continues on next page

5 Repair

5.6.4 Replacing the pulley on the ball screw lower position

Continued

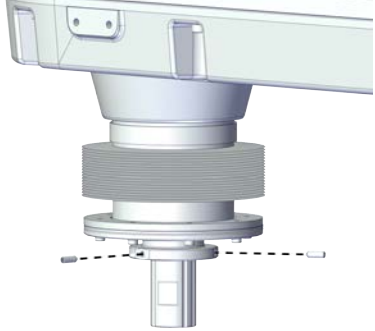
	Action	Note
5	<p>For robots with protection class IP54 (option 3350-540) For robots with protection type Clean Room (option 3351-1) Refit the locking screws.</p>	<p>Screws: Hexagon socket set screws with flat point, ISO 4026 stainless steel M3x8 (2 pcs) Tightening torque: 0.4 Nm \pm10%</p>  <p>xx2100002404</p>



Refitting the cover of the outer arm

	Action	Note
1	<p>For robots with protection type Clean Room: Clean the joints that have been opened and wipe the parts free from particles with spirit on a lint free. See Cut the paint or surface on the robot before replacing parts on page 118</p> <p> Note</p> <p>After all repair work, wipe the Clean Room robot free from particles with spirit on a lint free cloth.</p>	

Continues on next page

5.6.4 Replacing the pulley on the ball screw lower position

Continued

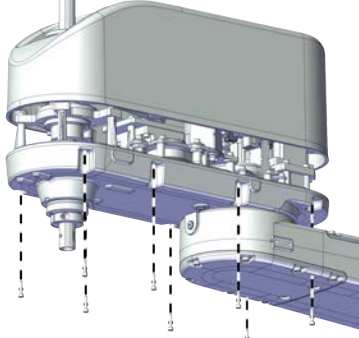
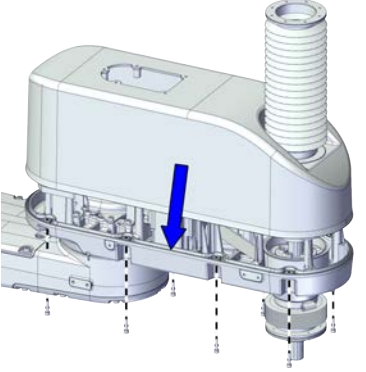
	Action	Note
2	<p>Refit the cover.</p> <p> Note</p> <p>For robots with protection class IP54 (option 3350-540)</p> <p>For robots with protection type Clean Room (option 3351-1)</p> <p>Refit the cover with bellow.</p> <p>Check the gasket for the outer arm cover.</p> <p> Tip</p> <p>Replace the gasket if needed.</p> <p> CAUTION</p> <p>The gasket is in the outer arm.</p>	<p>Screw: Hex socket head cap screw M4x16 12.9 Lafre 2C2B/FC6.9 (8 pcs)</p> <p>Tightening torque: 2 Nm ±10%</p> <p>For robots with protection class IP30 (option 3350-300)</p>  <p>xx210000933</p>
3	<p>Refit the screws.</p>	<p>For robots with protection class IP54 (option 3350-540)</p> <p>For robots with protection type Clean Room (option 3351-1)</p>  <p>xx2100002427</p>

For Clean Room/ IP54 robots

Refitting the top cover and the flange with bearing



	Action	Note
1	<p>For robots with protection type Clean Room:</p> <p>Clean the joints that have been opened and wipe the parts free from particles with spirit on a lint free. See Cut the paint or surface on the robot before replacing parts on page 118</p> <p> Note</p> <p>After all repair work, wipe the Clean Room robot free from particles with spirit on a lint free cloth.</p>	

Continues on next page

5 Repair

5.6.4 Replacing the pulley on the ball screw lower position

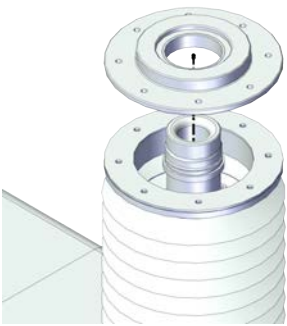
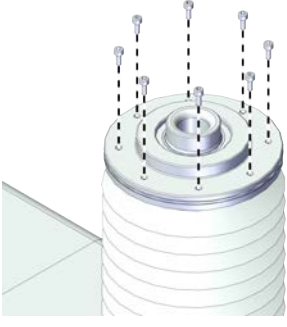
Continued

	Action	Note
2	<p>For robots with protection class IP54 (option 3350-540) For robots with protection type Clean Room (option 3351-1) Install the flange with bearing to the extension shaft.</p>	 <p>xx2100002402</p>
3	<p>For robots with protection class IP54 (option 3350-540) For robots with protection type Clean Room (option 3351-1) Refit the screws to the flange with bearing.</p>	<p>Screws: Hex socket head cap screw M2.5x6 12.9 Lafre 2C2B/FC6.9 (8 pcs) Tightening torque: 0.8 Nm \pm10%</p>  <p>xx2100002401</p>
4	<p>For robots with protection class IP54 (option 3350-540) For robots with protection type Clean Room (option 3351-1) Refit the top cover to the ball screw.</p> <p> Tip</p> <p>The top surface of the cover should be flush with the top end of the ball screw.</p>	 <p>xx2100002399</p>

Continues on next page

5.6.4 Replacing the pulley on the ball screw lower position
Continued

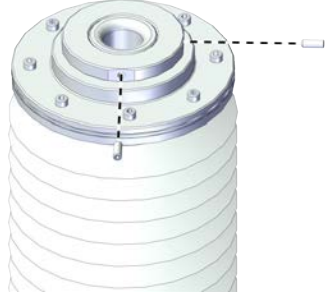
	Action	Note
5	<p>For robots with protection class IP54 (option 3350-540) For robots with protection type Clean Room (option 3351-1) Refit the locking screws.</p>	<p>Screws: Hexagon socket set screws with flat point, ISO 4026 stainless steel M3x8 (2 pcs) Tightening torque: 0.4 Nm ±10%</p>  <p>xx2100002398</p>

Securing the process hub to outer arm cover



	Action	Note
1	<p>For robots with protection type Clean Room: Clean the joints that have been opened and wipe the parts free from particles with spirit on a lint free. See Cut the paint or surface on the robot before replacing parts on page 118</p> <p> Note</p> <p>After all repair work, wipe the Clean Room robot free from particles with spirit on a lint free cloth.</p>	
2	Insert the process hub from the outer arm cover.	

Continues on next page

5 Repair

5.6.4 Replacing the pulley on the ball screw lower position

Continued

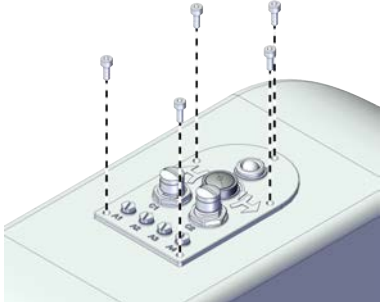
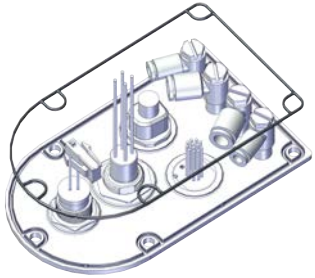
	Action	Note
3	<p>Secure the process hub to the outer arm cover with the screws.</p> <p> Note</p> <p>For robots with protection class IP54 (option 3350-540) For robots with protection type Clean Room (option 3351-1) Check the gasket for the process hub.</p> <p> Tip</p> <p>Replace the gasket if needed.</p> <p> CAUTION</p> <p>Be aware of the cabling that is attached to the cover! The cover can not be removed completely until the connectors are disconnected, as shown in following steps.</p>	<p>Screws: Hex socket head cap screw M4x10 12.9 Lafre 2C2B/FC6.9 (5 pcs) Tightening torque: 2.6 Nm±10% For robots with protection class IP30 (option 3350-300)</p>  <p>xx2100000932</p> <p>For robots with protection class IP54 (option 3350-540) For robots with protection type Clean Room (option 3351-1)</p>  <p>xx2100002438</p>

Concluding procedure

	Action	Note
1	<p>For robots with protection type Clean Room: Seal and paint the joints that have been opened. See Cut the paint or surface on the robot before replacing parts on page 118</p> <p> Note</p> <p>After all repair work, wipe the Clean Room robot free from particles with spirit on a lint free cloth.</p>	
2	Recalibrate the robot.	Calibration is detailed in section Calibration on page 945 .

Continues on next page

5.6.4 Replacing the pulley on the ball screw lower position*Continued*

	Action	Note
3	 DANGER Make sure all safety requirements are met when performing the first test run.	

5 Repair

5.6.5 Replacing the ball screw

5.6.5 Replacing the ball screw

Location of the ball screw

The ball screw is located as shown in the figure.

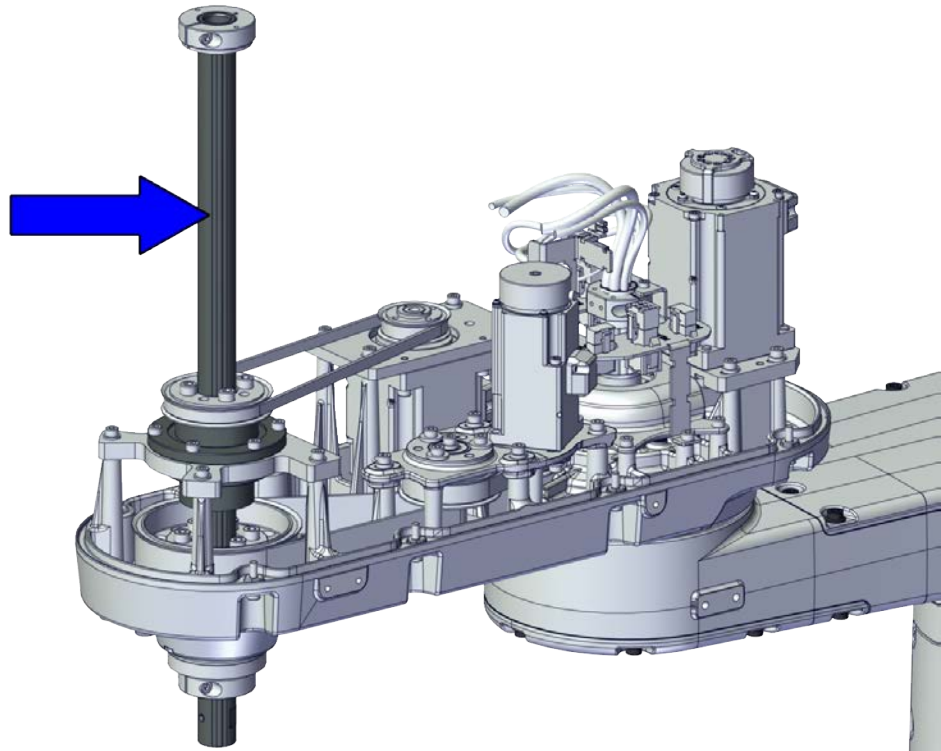

xx2100001019

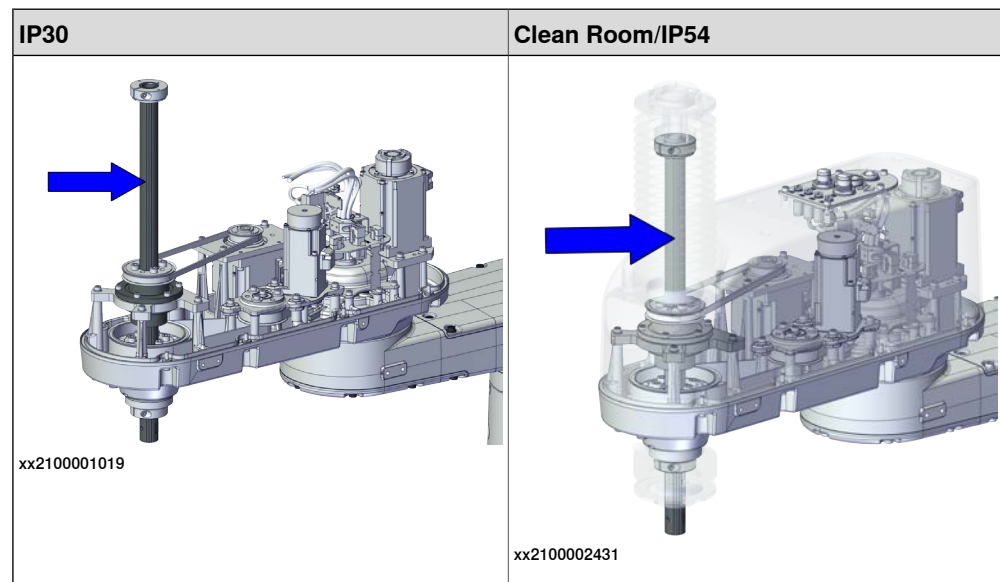

Continues on next page

**CAUTION**

For the robots with protection type Clean Room and protection class IP54, the ball screw spline unit is inside the bellows. If needed, remove the bellows to inspect the ball screw spline unit.

For details about how to remove the bellows, see [Replacing the bellows](#).

Required spare parts**Note**

The spare part numbers that are listed in the table can be out of date. See the latest spare parts of the IRB 920 via myABB Business Portal,

www.abb.com/myABB.

Spare part	Article number	Note
Ball screw, BNS2020A+395LC5	3HAC070477-001	Used for IRB 920T-6/0.45_0.18, IRB 920T-6/0.55_0.18 and IRB 920T-6/0.65_0.18
Ball screw, BNS2020A+515LC5	3HAC072983-001	Used for IRB 920T-6/0.45_0.3, IRB 920T-6/0.55_0.3 and IRB 920T-6/0.65_0.3
Ball Screw Flange	3HAC070479-001	Used for IRB 920T-6/0.45_0.18, IRB 920T-6/0.55_0.18 and IRB 920T-6/0.65_0.18
Mechanical-Stop top, D20	3HAC073068-001	With bolt
Mechanical-Stop bottom, D20	3HAC073069-001	With bolt

Required tools and equipment

Equipment	Article number	Note
Standard toolkit	-	Content is defined in section Standard toolkit on page 996 .
IRB 920 special tool	3HAC077249-001	Used to install the ball screw nut. Special tool for L2
Calibration toolbox, Axis Calibration	3HAC055412-001	Delivered as a set of calibration tools. Required if Axis Calibration is the valid calibration method for the robot.
24 VDC power supply	-	Used to release the motor brakes.
Sonic tension meter	-	Used for measuring the timing belt tension.
Handheld dynamometer	-	Used for measuring the timing belt tension.

Continues on next page

5 Repair

5.6.5 Replacing the ball screw

Continued

Required consumables

Consumable	Article number	Note
Cable straps	-	
Grease	-	THK AFA

Deciding calibration routine

Decide which calibration routine to be used, based on the information in the table. Depending on which routine is chosen, action might be required prior to beginning the repair work of the robot, see the table.

	Action	Note
1	Decide which calibration routine to use for calibrating the robot. <ul style="list-style-type: none">Reference calibration. External cable packages (DressPack) and tools can stay fitted on the robot.Fine calibration. All external cable packages (DressPack) and tools must be removed from the robot.	
	If the robot is to be calibrated with reference calibration: Find previous reference values for the axis or create new reference values. These values are to be used after the repair procedure is completed, for calibration of the robot. If no previous reference values exist, and no new reference values can be created, then reference calibration is not possible.	Follow the instructions given in the reference calibration routine on the FlexPendant to create reference values. Creating new values requires possibility to move the robot. Read more about reference calibration for Axis Calibration in Reference calibration routine on page 957 .
	If the robot is to be calibrated with fine calibration: Remove all external cable packages (DressPack) and tools from the robot.	



Removing the ball screw

Use these procedures to remove the ball screw.



Preparations before removing the ball screw

	Action	Note
1	Decide which calibration routine to use, and take actions accordingly prior to beginning the repair procedure.	
2	If there is no enough space for the maintenance work, remove the robot from the wall and place it on the maintenance bracket.  CAUTION Do not lay down the robot during the transportation, always keep it straight. If the robot lay down in any situation, the grease may come out from gearbox.	

Continues on next page

	Action	Note
3	 DANGER Turn off all: <ul style="list-style-type: none"> • electric power supply • hydraulic pressure supply • air pressure supply to the robot, before entering the safeguarded space.	
4	 CAUTION For robots with protection type Clean Room Always cut the paint with a knife and grind the paint edge when disassembling parts of the robot! See Cut the paint or surface on the robot before replacing parts on page 118 .	

Removing the process hub screws



	Action	Note
1	 DANGER Make sure that all supplies for electrical power, hydraulic pressure, and air pressure are turned off.	
2	 CAUTION For robots with protection type Clean Room Always cut the paint with a knife and grind the paint edge when disassembling parts of the robot! See Cut the paint or surface on the robot before replacing parts on page 118 .	

Continues on next page

5 Repair

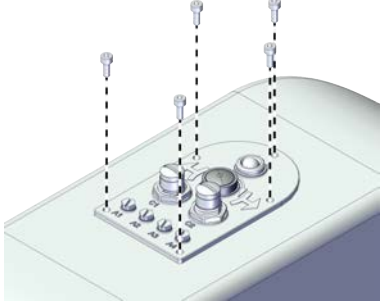
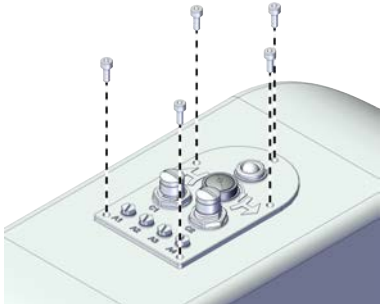

5.6.5 Replacing the ball screw

Continued



	Action	Note
3	<p>Remove the screws on the process hub.</p> <p> Note</p> <p>For robots with protection class IP54 (option 3350-540)</p> <p>For robots with protection type Clean Room (option 3351-1)</p> <p>Remove the screws on the process hub and take out the gasket.</p> <p> Tip</p> <p>Check the gasket and replace it if needed.</p>	<p>For robots with protection class IP30</p>  <p>xx2100000932</p> <p>For robots with protection class IP54 (option 3350-540)</p> <p>For robots with protection type Clean Room (option 3351-1)</p>  <p>xx2100000932</p>
4	Insert the process hub to the outer arm.	

For Clean Room/ IP54 robots

Removing the top cover and the flange with bearing

	Action	Note
1	<p> DANGER</p> <p>Make sure that all supplies for electrical power, hydraulic pressure, and air pressure are turned off.</p>	
2	<p> CAUTION</p> <p>For robots with protection type Clean Room</p> <p>Always cut the paint with a knife and grind the paint edge when disassembling parts of the robot! See Cut the paint or surface on the robot before replacing parts on page 118.</p>	

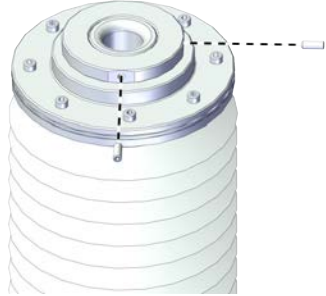
Continues on next page

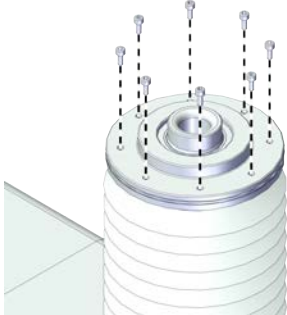
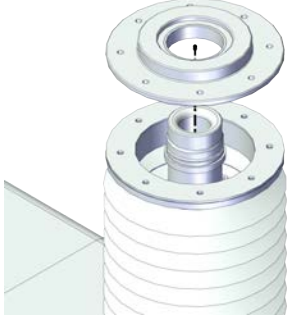
	Action	Note
3	<p>For robots with protection class IP54 (option 3350-540) For robots with protection type Clean Room (option 3351-1) Loose the locking screws.</p>	 <p>xx2100002398</p>
4	<p>For robots with protection class IP54 (option 3350-540) For robots with protection type Clean Room (option 3351-1) Remove the top cover from the ball screw.</p>	 <p>xx2100002399</p>
5	<p>For robots with protection class IP54 (option 3350-540) For robots with protection type Clean Room (option 3351-1) Remove the screws on the flange with bearing.</p>	 <p>xx2100002401</p>
6	<p>For robots with protection class IP54 (option 3350-540) For robots with protection type Clean Room (option 3351-1) Remove the flange with bearing.</p>	 <p>xx2100002402</p>







Continues on next page

5 Repair

5.6.5 Replacing the ball screw

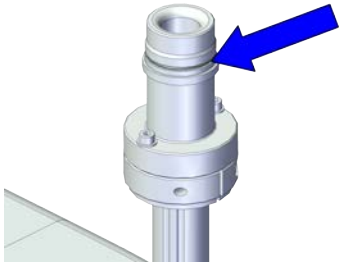

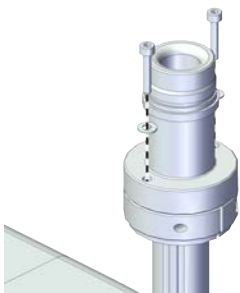

Continued

Removing the extension shaft for Clean Room/ IP54 robots

	Action	Note
1	 DANGER Make sure that all supplies for electrical power, hydraulic pressure, and air pressure are turned off.	
2	 CAUTION For robots with protection type Clean Room Always cut the paint with a knife and grind the paint edge when disassembling parts of the robot! See Cut the paint or surface on the robot before replacing parts on page 118 .	
3	For robots with protection class IP54 (option 3350-540) For robots with protection type Clean Room (option 3351-1) Remove the O-ring from the upper housing.	 <small>xx2100002419</small>
4	For robots with protection class IP54 (option 3350-540) For robots with protection type Clean Room (option 3351-1) Loose the attachment screws.  Note For robots with protection class IP54 (option 3350-540) Clean the upper housing from the glue if it will be reused.	 <small>xx2100002420</small>
5	For robots with protection class IP54 (option 3350-540) For robots with protection type Clean Room (option 3351-1) Remove the extension shaft from the mechanical stopper.  Note For robots with protection class IP54 (option 3350-540) Check the gasket for the extension shaft and replace it if needed.	 <small>xx2100002421</small>

Continues on next page

Removing the cover of the outer arm

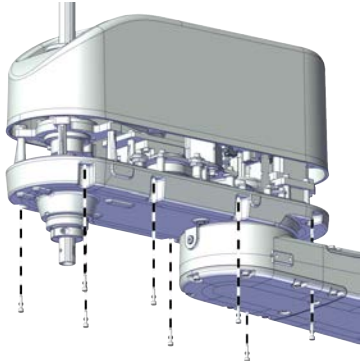
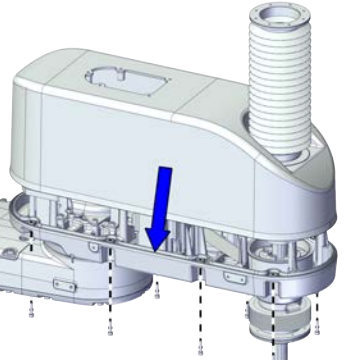
	Action	Note
1	 DANGER Make sure that all supplies for electrical power, hydraulic pressure, and air pressure are turned off.	
2	 CAUTION For robots with protection type Clean Room Always cut the paint with a knife and grind the paint edge when disassembling parts of the robot! See Cut the paint or surface on the robot before replacing parts on page 118 .	
3	<p>Remove the screws on the cover of the outer arm and remove the cover.</p>  Note For robots with protection class IP54 (option 3350-540) For robots with protection type Clean Room (option 3351-1) Remove the cover with bellow and housing.  Note The bellow does not need to be removed separately.  Tip Check the gasket and replace it if needed.	<p>For robots with protection class IP30</p>  <p>xx210000933</p> <p>For robots with protection class IP54 (option 3350-540) For robots with protection type Clean Room (option 3351-1)</p>  <p>xx2100002427</p>

Continues on next page





5 Repair

5.6.5 Replacing the ball screw

Continued

For Clean Room/ IP54 robots

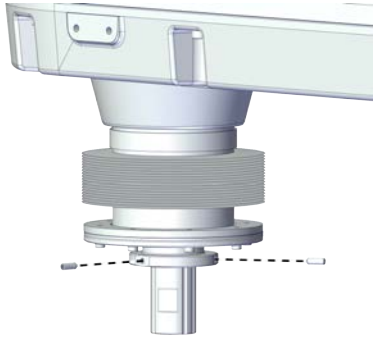

Removing the lower cover and the flange with bearing

	Action	Note
1	 DANGER Make sure that all supplies for electrical power, hydraulic pressure, and air pressure are turned off.	
2	 CAUTION For robots with protection type Clean Room Always cut the paint with a knife and grind the paint edge when disassembling parts of the robot! See Cut the paint or surface on the robot before replacing parts on page 118 .	
3	For robots with protection class IP54 (option 3350-540) For robots with protection type Clean Room (option 3351-1) Loose the locking screws.	 xx2100002404
4	For robots with protection class IP54 (option 3350-540) For robots with protection type Clean Room (option 3351-1) Remove the lower cover from the ball screw.	 xx2100002405

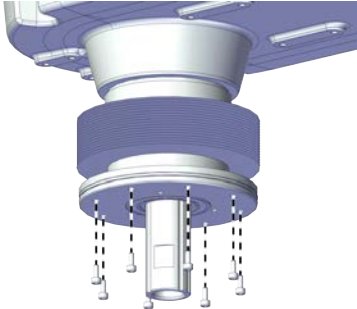
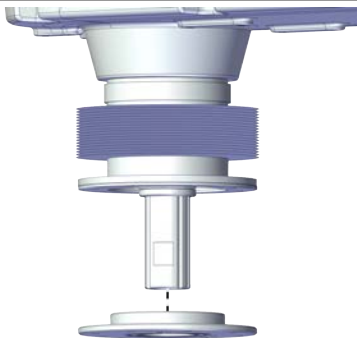
Continues on next page

	Action	Note
5	<p>For robots with protection class IP54 (option 3350-540)</p> <p>For robots with protection type Clean Room (option 3351-1)</p> <p>Remove the screws on the flange with bearing.</p>	 <p>xx2100002406</p>
6	<p>For robots with protection class IP54 (option 3350-540)</p> <p>For robots with protection type Clean Room (option 3351-1)</p> <p>Remove the flange with bearing.</p>	 <p>xx2100002407</p>

Removing the lower bellow





	Action	Note
1	 <p>DANGER</p> <p>Make sure that all supplies for electrical power, hydraulic pressure, and air pressure are turned off.</p>	
2	 <p>CAUTION</p> <p>For robots with protection type Clean Room</p> <p>Always cut the paint with a knife and grind the paint edge when disassembling parts of the robot! See Cut the paint or surface on the robot before replacing parts on page 118.</p>	

Continues on next page

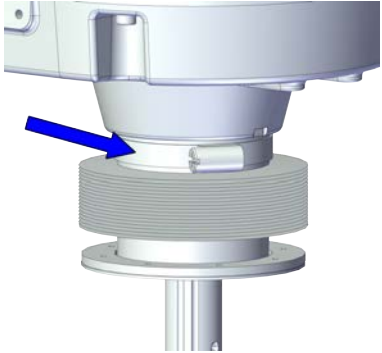

5 Repair

5.6.5 Replacing the ball screw

Continued



	Action	Note
3	<p>For robots with protection class IP54 (option 3350-540)</p> <p>For robots with protection type Clean Room (option 3351-1)</p> <p>Loosen the upper bellow clamp by loosening the screw and pull the clamp apart slightly.</p>	 <p>xx2100002408</p>
4	<p>For robots with protection class IP54 (option 3350-540)</p> <p>For robots with protection type Clean Room (option 3351-1)</p> <p>Remove the bellow from the outer arm.</p> <p> Note</p> <p>For robots with protection class IP54 (option 3350-540)</p> <p>Clean the bellow from the glue if it will be reused.</p>	
5	<p>For robots with protection class IP54 (option 3350-540)</p> <p>Remove the bellow gasket from the bellow.</p> <p> Note</p> <p>Clean the bellow gasket from the glue if it will be reused.</p> <p> Note</p> <p>Be careful when removing the bellow gaskets. If any broken, replace it.</p>	

Removing the shaft for Clean Room/ IP54 robots

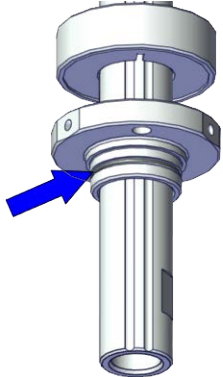
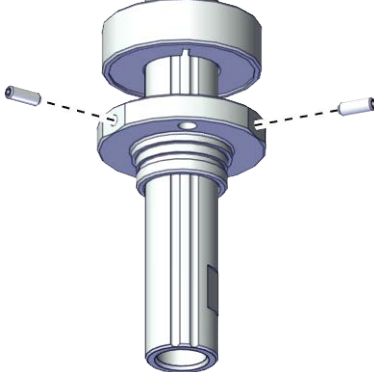

	Action	Note
1	<p> DANGER</p> <p>Make sure that all supplies for electrical power, hydraulic pressure, and air pressure are turned off.</p>	
2	<p> CAUTION</p> <p>For robots with protection type Clean Room</p> <p>Always cut the paint with a knife and grind the paint edge when disassembling parts of the robot! See Cut the paint or surface on the robot before replacing parts on page 118.</p>	

Continues on next page

5.6.5 Replacing the ball screw
Continued

	Action	Note
3	For robots with protection class IP54 (option 3350-540) For robots with protection type Clean Room (option 3351-1) Remove the O-ring from the lower housing.	 <p>xx1900001615</p>
4	For robots with protection class IP54 (option 3350-540) For robots with protection type Clean Room (option 3351-1) Loosen the attachment screws.	 <p>xx1900001616</p>
5	For robots with protection class IP54 (option 3350-540) For robots with protection type Clean Room (option 3351-1) Remove the shaft from the mechanical stopper.  Note The shaft is glued to the ball screw. Be careful with the glue when removing the shaft.	

Removing the axis-3 timing belt

	Action	Note
1	 DANGER Make sure that all supplies for electrical power, hydraulic pressure, and air pressure are turned off.	
2	 CAUTION For robots with protection type Clean Room Always cut the paint with a knife and grind the paint edge when disassembling parts of the robot! See Cut the paint or surface on the robot before replacing parts on page 118 .	

Continues on next page



5 Repair

5.6.5 Replacing the ball screw

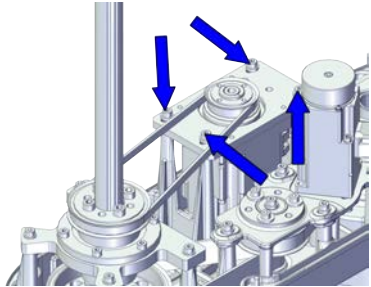
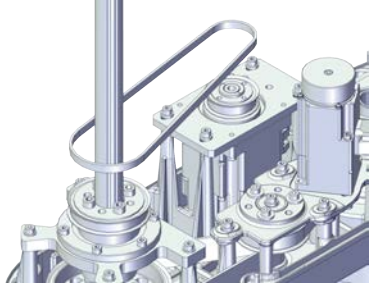
Continued



	Action	Note
3	 DANGER Make sure that the ball screw is supported with something. The sudden drop of the ball screw due the lost of the axis-3 motor may cause danger.	
4	Loosen the screws of the axis-3 motor sub-assembly to let the axis-3 timing belt free.	 xx2100001078
5	Remove the timing belt.	 xx2100001079

Removing the lower mechanical stopper

	Action	Note
1	 DANGER Make sure that all supplies for electrical power, hydraulic pressure, and air pressure are turned off.	
2	 CAUTION For robots with protection type Clean Room Always cut the paint with a knife and grind the paint edge when disassembling parts of the robot! See <i>Cut the paint or surface on the robot before replacing parts on page 118.</i>	

Continues on next page

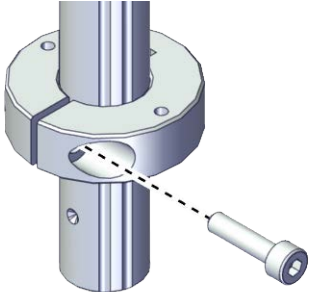
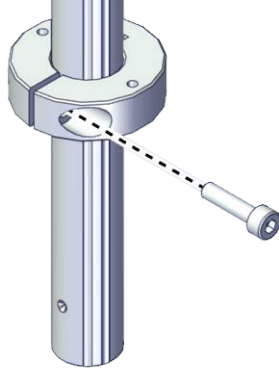
5.6.5 Replacing the ball screw
Continued

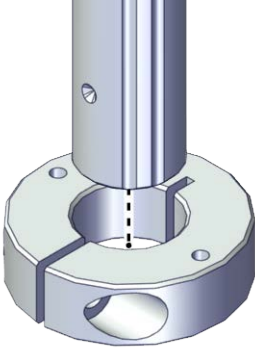
	Action	Note
3	Remove the screw.	<p>For robots with protection class IP30 (option 3350-300)</p>  <p>xx1800002860</p> <p>For robots with protection class IP54 (option 3350-540) For robots with protection type Clean Room (option 3351-1)</p>  <p>xx1900001642</p>
4	<p>Remove the mechanical stopper.</p> <p> CAUTION</p> <p>If the ball screw nut or ball screw spline nut go out of the screw shaft, the ball screw is destroyed. Be careful when you do any work that may cause this.</p>	 <p>xx1800002861</p>

Removing the ball screw with the flange



	Action	Note
1	<p> DANGER</p> <p>Make sure that all supplies for electrical power, hydraulic pressure, and air pressure are turned off.</p>	

Continues on next page



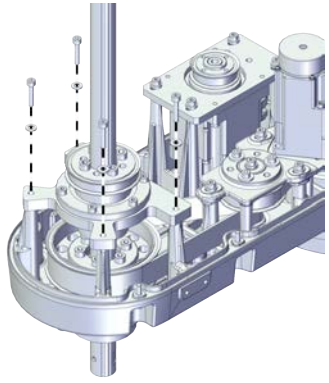
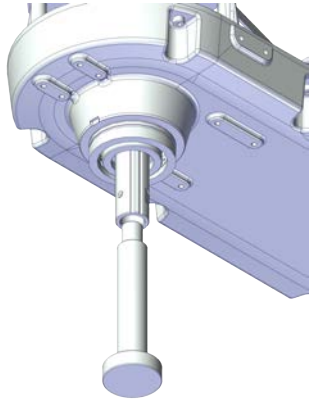

5 Repair

5.6.5 Replacing the ball screw

Continued

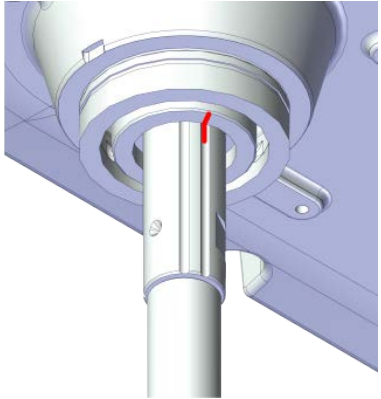
	Action	Note
2	 ELECTROSTATIC DISCHARGE (ESD) The unit is sensitive to ESD. Before handling the unit read the safety information in section The unit is sensitive to ESD on page 49 .	
3	 CAUTION For robots with protection type Clean Room Always cut the paint with a knife and grind the paint edge when disassembling parts of the robot! See Cut the paint or surface on the robot before replacing parts on page 118 .	
4	Remove the screws and washers on the ball screw flange.	 xx2100001082
5	Insert the special tool into the ball screw shaft.	IRB 920 special tool:3HAC077249-001  xx2100001129

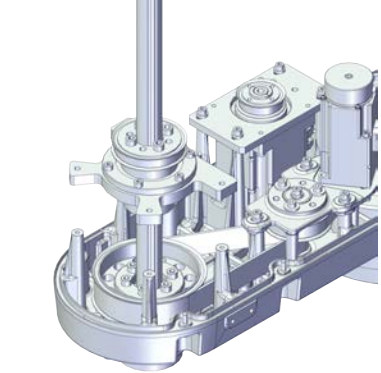
Continues on next page

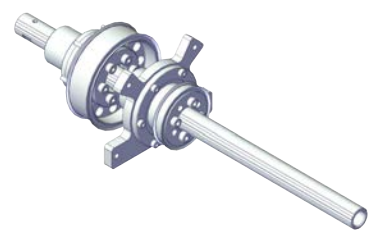
	Action	Note
6	Mark the location of the ball screw shaft grooves on the ball screw lower nut.	 <p>xx2100001187</p>
7	Take out the ball screw with the flange assembly carefully.  CAUTION Move the special tool along with the ball screw shaft until it is totally inserted into the lower nut of the ball screw and keep the status. When the special tool is totally inserted to the lower nut of the ball screw, support the special tool with some thing. Or the ball screw lower nut will be destroyed.	 <p>xx2100001083</p>
8	Lay down the ball screw assembly.  CAUTION If the ball screw nut or ball screw spline nut go out of the screw shaft, the ball screw is destroyed. Be careful when you do any work that may cause this.	 <p>xx2100001084</p>

Loosening the transmission module screws



	Action	Note
1	 DANGER Make sure that all supplies for electrical power, hydraulic pressure, and air pressure are turned off.	

Continues on next page



5 Repair

5.6.5 Replacing the ball screw

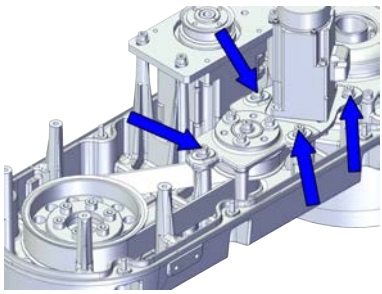

Continued

	Action	Note
2	 CAUTION For robots with protection type Clean Room Always cut the paint with a knife and grind the paint edge when disassembling parts of the robot! See Cut the paint or surface on the robot before replacing parts on page 118 .	
3	 DANGER Make sure that the ball screw is supported with something. The sudden drop of the ball screw due the lost of the axis-3 motor may cause danger.	
4	Loosen the screws of the transmission module to let the axis-4-2 timing belt free.	 xx2100001081

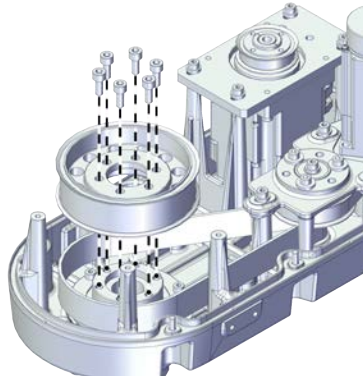

Removing the pulley on the ball screw lower position

	Action	Note
1	 DANGER Make sure that all supplies for electrical power, hydraulic pressure, and air pressure are turned off.	
2	 ELECTROSTATIC DISCHARGE (ESD) The unit is sensitive to ESD. Before handling the unit read the safety information in section The unit is sensitive to ESD on page 49 .	
3	 CAUTION For robots with protection type Clean Room Always cut the paint with a knife and grind the paint edge when disassembling parts of the robot! See Cut the paint or surface on the robot before replacing parts on page 118 .	

Continues on next page

	Action	Note
4	Remove the screws and washers.	 <p>xx2100001085</p>
5	Remove the pulley carefully.  CAUTION If the ball screw nut or ball screw spline nut go out of the screw shaft, the ball screw is destroyed. Be careful when you do any work that may cause this.	

Removing the ball screw lower nut



	Action	Note
1	 DANGER Make sure that all supplies for electrical power, hydraulic pressure, and air pressure are turned off.	
2	 CAUTION For robots with protection type Clean Room Always cut the paint with a knife and grind the paint edge when disassembling parts of the robot! See Cut the paint or surface on the robot before replacing parts on page 118.	

Continues on next page

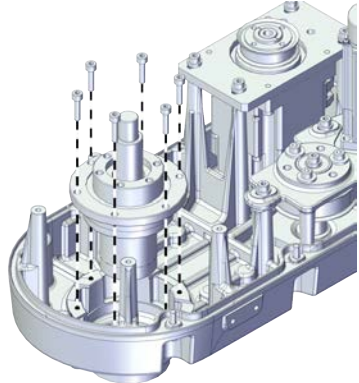

5 Repair

5.6.5 Replacing the ball screw



Continued

	Action	Note
3	<p>Remove the screws on the lower nut to the outer arm.</p> <p> Tip</p> <p>Hold the ball screw to prevent it from dropping. Or the ball screw may be destroyed.</p>	<p>IRB 920 special tool:3HAC077249-001</p>  <p>xx2100001088</p>
4	<p>Raise the ball screw lower nut with the special tool to take them out of the outer arm carefully.</p> <p> Tip</p> <p>Hold the lower part of the ball screw to prevent it from dropping. Or the ball screw may be destroyed.</p> <p> CAUTION</p> <p>If the ball screw nut or ball screw spline nut go out of the screw shaft, the ball screw is destroyed. Be careful when you do any work that may cause this.</p>	

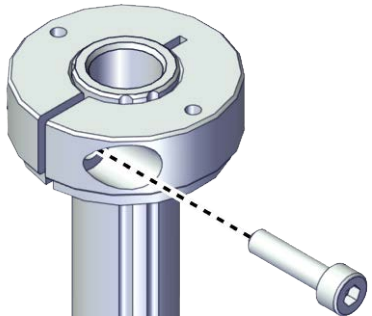

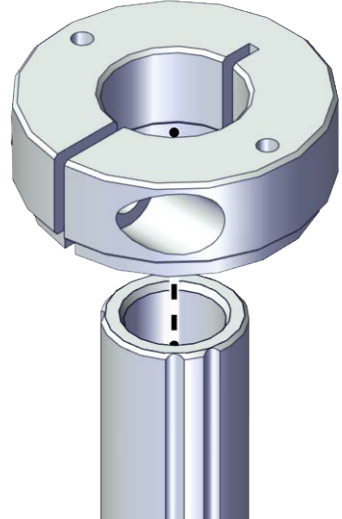

Removing the upper mechanical stopper

	Action	Note
1	<p> DANGER</p> <p>Make sure that all supplies for electrical power, hydraulic pressure, and air pressure are turned off.</p>	
2	<p> CAUTION</p> <p>For robots with protection type Clean Room Always cut the paint with a knife and grind the paint edge when disassembling parts of the robot! See Cut the paint or surface on the robot before replacing parts on page 118.</p>	
3	<p>Remove the screw.</p>	 <p>xx1800002858</p>

Continues on next page

	Action	Note
4	<p>Remove the mechanical stopper.</p> <p> Tip</p> <p>Hold the ball screw to prevent it from dropping. Or the ball screw may be destroyed.</p> <p> CAUTION</p> <p>If the ball screw nut or ball screw spline nut go out of the screw shaft, the ball screw is destroyed. Be careful when you do any work that may cause this.</p>	 <p>xx1800002859</p>

Removing the pulley on the ball screw upper position

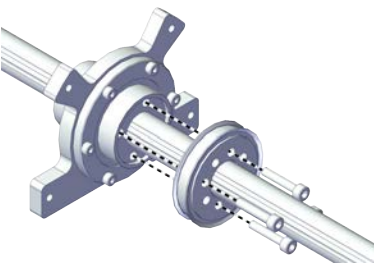
	Action	Note
1	<p> DANGER</p> <p>Make sure that all supplies for electrical power, hydraulic pressure, and air pressure are turned off.</p>	
2	<p> ELECTROSTATIC DISCHARGE (ESD)</p> <p>The unit is sensitive to ESD. Before handling the unit read the safety information in section The unit is sensitive to ESD on page 49.</p>	
3	<p> CAUTION</p> <p>For robots with protection type Clean Room</p> <p>Always cut the paint with a knife and grind the paint edge when disassembling parts of the robot! See Cut the paint or surface on the robot before replacing parts on page 118.</p>	
4	<p>Remove the screws.</p>	
5	<p>Remove the pulley carefully.</p> <p> CAUTION</p> <p>If the ball screw nut or ball screw spline nut go out of the screw shaft, the ball screw is destroyed. Be careful when you do any work that may cause this.</p>	 <p>xx2100001089</p>





Continues on next page

5 Repair

5.6.5 Replacing the ball screw

Continued

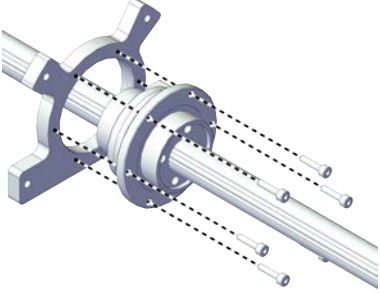
Removing the ball screw flange

	Action	Note
1	 DANGER Make sure that all supplies for electrical power, hydraulic pressure, and air pressure are turned off.	
2	 CAUTION For robots with protection type Clean Room Always cut the paint with a knife and grind the paint edge when disassembling parts of the robot! See Cut the paint or surface on the robot before replacing parts on page 118 .	
3	Remove the screws.	 <small>xx2100001090</small>
4	Remove the ball screw flange from the ball screw shaft.  CAUTION If the ball screw nut or ball screw spline nut go out of the screw shaft, the ball screw is destroyed. Be careful when you do any work that may cause this.	



Refitting the ball screw

Use these procedures to refit the ball screw.

Preparing the new ball screw

	Action	Note
1	For robots with protection type Clean Room: Clean the joints that have been opened and wipe the parts free from particles with spirit on a lint free. See Cut the paint or surface on the robot before replacing parts on page 118  Note After all repair work, wipe the Clean Room robot free from particles with spirit on a lint free cloth.	

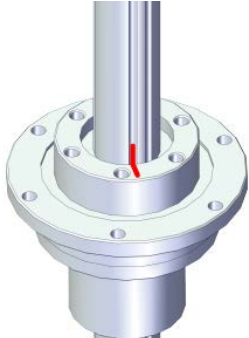
Continues on next page

	Action	Note
2	Mark the location of the ball screw shaft grooves on the ball screw lower nut.	 <p>xx2100001184</p>
3	Insert the special tool into the ball screw shaft.	<p>IRB 920 special tool:3HAC077249-001</p>  <p>xx2100001185</p>
4	Move the ball screw nut from the ball screw shaft to the special tool.	 <p>xx2100001186</p>

Refitting the ball screw lower nut



	Action	Note
1	 <p>DANGER</p> <p>Make sure that all supplies for electrical power, hydraulic pressure, and air pressure are turned off.</p>	

Continues on next page



5 Repair

5.6.5 Replacing the ball screw

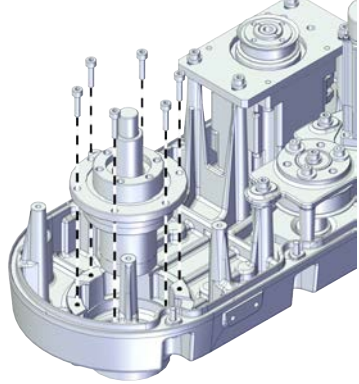

Continued

	Action	Note
2	 CAUTION For robots with protection type Clean Room Always cut the paint with a knife and grind the paint edge when disassembling parts of the robot! See Cut the paint or surface on the robot before replacing parts on page 118 .	
3	Put the ball screw lower nut to the outer arm carefully.  CAUTION Make sure the ball screw nut works fluently.	Screws: Hex socket head cap screw M4x16 12.9 Lafre 2C2B/FC6.9 (6 pcs) Tightening torque: 3.5 Nm \pm 10%
4	Secure the screws on the lower nut to the outer arm.	 xx2100001088

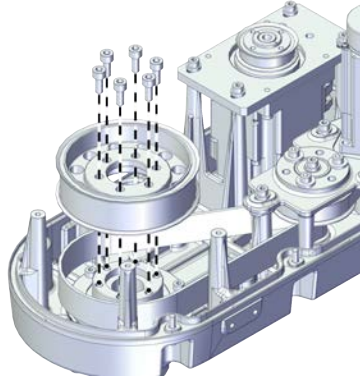

Refitting the pulley on the ball screw lower position

	Action	Note
1	 ELECTROSTATIC DISCHARGE (ESD) The unit is sensitive to ESD. Before handling the unit read the safety information in section The unit is sensitive to ESD on page 49 .	
2	For robots with protection type Clean Room: Clean the joints that have been opened and wipe the parts free from particles with spirit on a lint free. See Cut the paint or surface on the robot before replacing parts on page 118  Note After all repair work, wipe the Clean Room robot free from particles with spirit on a lint free cloth.	

Continues on next page

	Action	Note
3	<p>Refit the pulley to the ball screw carefully.</p> <p> CAUTION</p> <p>If the ball screw nut or ball screw spline nut go out of the screw shaft, the ball screw is destroyed. Be careful when you do any work that may cause this.</p>	<p>Screws: Hex socket head cap screw M5x12 12.9 Lafre 2C2B/FC6.9 (6 pcs) Washers: Spring washer 9x4.3x1 Steel (6 pcs) Tightening torque: 4.4 Nm \pm10%</p>  <p>xx2100001085</p>
4	<p>Refit the screws.</p> <p> Tip</p> <p>Secure with the stopping tool to prevent the pulley from rotating.</p>	

Refitting the flange to the ball screw shaft

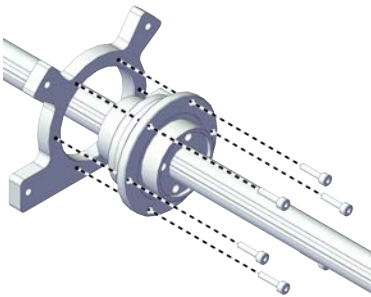
	Action	Note
1	<p>For robots with protection type Clean Room: Clean the joints that have been opened and wipe the parts free from particles with spirit on a lint free. See Cut the paint or surface on the robot before replacing parts on page 118</p> <p> Note</p> <p>After all repair work, wipe the Clean Room robot free from particles with spirit on a lint free cloth.</p>	
2	<p>Refit the ball screw flange to the ball screw shaft.</p> <p> CAUTION</p> <p>If the ball screw nut or ball screw spline nut go out of the screw shaft, the ball screw is destroyed. Be careful when you do any work that may cause this.</p>	<p>Screws: Hex socket head cap screw M4x16 12.9 Lafre 2C2B/FC6.9 (6 pcs) Tightening torque: 3.5 Nm \pm10%</p>  <p>xx2100001090</p>
3	<p>Refit the screws.</p>	





Continues on next page

5 Repair

5.6.5 Replacing the ball screw

Continued

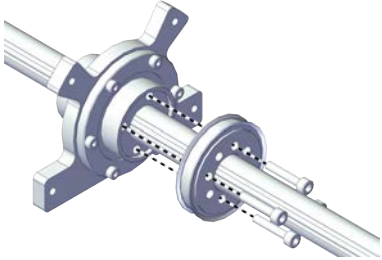

Refitting the pulley on the ball screw upper position

	Action	Note
1	 ELECTROSTATIC DISCHARGE (ESD) The unit is sensitive to ESD. Before handling the unit read the safety information in section The unit is sensitive to ESD on page 49 .	
2	For robots with protection type Clean Room: Clean the joints that have been opened and wipe the parts free from particles with spirit on a lint free. See Cut the paint or surface on the robot before replacing parts on page 118  Note After all repair work, wipe the Clean Room robot free from particles with spirit on a lint free cloth.	
3	Refit the pulley to the ball screw carefully.  CAUTION If the ball screw nut or ball screw spline nut go out of the screw shaft, the ball screw is destroyed. Be careful when you do any work that may cause this.	Screws: Hex socket head cap screw M4x16 12.9 Lafre 2C2B/FC6.9 (4 pcs) Tightening torque: 4.4 Nm ±10% 
4	Refit the screws.  Tip Secure with the stopping tool to prevent the pulley from rotating.	xx2100001089

Refitting the upper mechanical stopper

	Action	Note
1	For robots with protection type Clean Room: Clean the joints that have been opened and wipe the parts free from particles with spirit on a lint free. See Cut the paint or surface on the robot before replacing parts on page 118  Note After all repair work, wipe the Clean Room robot free from particles with spirit on a lint free cloth.	

Continues on next page

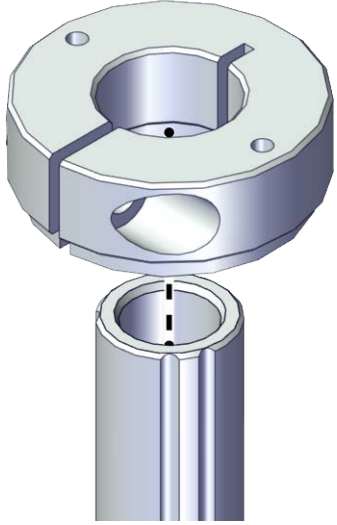
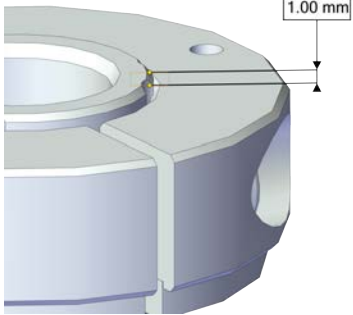
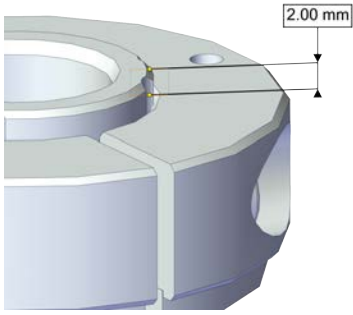
	Action	Note
2	<p>Refit the mechanical stopper to the ball screw at 1 mm position to the upper of the ball screw.</p> <p> Note</p> <p>For robots with protection class IP54 (option 3350-540) For robots with protection type Clean Room (option 3351-1) Refit the mechanical stopper to the ball screw at 2 mm position to the upper of the ball screw.</p> <p> Tip</p> <p>Hold the ball screw to prevent it from dropping. Or the ball screw may be destroyed.</p> <p> CAUTION</p> <p>If the ball screw nut or ball screw spline nut go out of the screw shaft, the ball screw is destroyed. Be careful when you do any work that may cause this.</p>	 <p>xx1800002859</p> <p>For robots with protection class IP30 (option 3350-300)</p>  <p>xx1900002012</p> <p>For robots with protection class IP54 (option 3350-540) For robots with protection type Clean Room (option 3351-1)</p>  <p>xx1900002011</p>

Continues on next page



5 Repair

5.6.5 Replacing the ball screw

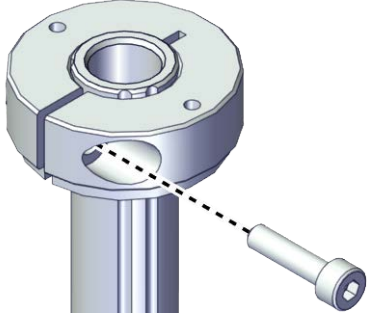
Continued

	Action	Note
3	Refit the screw.	<p>Screws: Hex socket head cap screw M4x16 12.9 Lafre 2C2B/FC6.9 (1 pcs) Tightening torque: 6.5 Nm</p>  <p>xx1800002858</p>

Refitting the ball screw with the flange

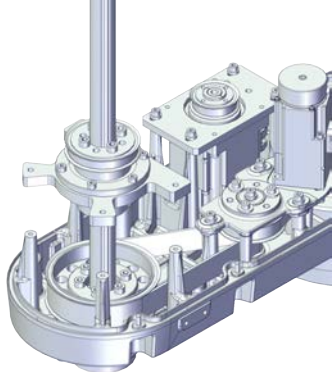
	Action	Note
1	<p>For robots with protection type Clean Room: Clean the joints that have been opened and wipe the parts free from particles with spirit on a lint free. See Cut the paint or surface on the robot before replacing parts on page 118</p> <p> Note</p> <p>After all repair work, wipe the Clean Room robot free from particles with spirit on a lint free cloth.</p>	
2	<p>Refit the ball screw assembly to the outer arm.</p> <p> Tip</p> <p>Make sure the marked location is aligned with the ball screw shaft grooves.</p> <p> CAUTION</p> <p>With the inserting of the ball screw shaft, remove the special tool along with the ball screw shaft carefully.</p>	<p>IRB 920 special tool:3HAC077249-001</p>  <p>xx2100001083</p>

Continues on next page

5.6.5 Replacing the ball screw
Continued

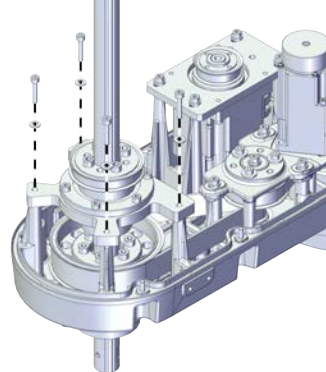
	Action	Note
3	<p>Refit the screws and washers to secure the ball screw flange to the outer arm.</p> <p> Tip</p> <p>Pre-tighten the screws at 0.5Nm and slide the ball screw up and down for five times. Then tighten the screws at 3.8Nm to secure it.</p>	<p>Screws: Hex socket head cap screw M4x20 12.9 Lafre 2C2B/FC6.9 (4 pcs)</p> <p>Washers: Spring washer 9x4.3x1 Steel (4 pcs)</p> <p>Tightening torque: 3.5 Nm ±10%</p>  <p>xx2100001082</p>

Refitting the mechanical stopper





	Action	Note
1	<p>For robots with protection type Clean Room: Clean the joints that have been opened and wipe the parts free from particles with spirit on a lint free. See Cut the paint or surface on the robot before replacing parts on page 118</p> <p> Note</p> <p>After all repair work, wipe the Clean Room robot free from particles with spirit on a lint free cloth.</p>	

Continues on next page

5 Repair

5.6.5 Replacing the ball screw

Continued

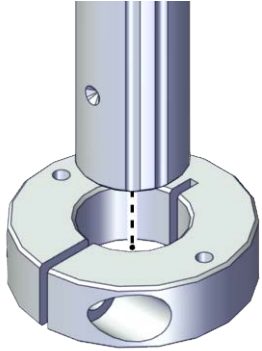
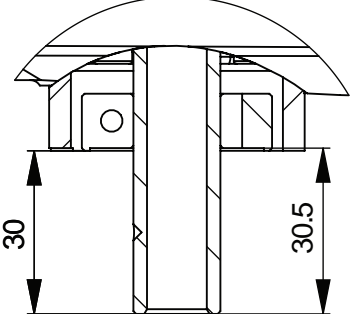
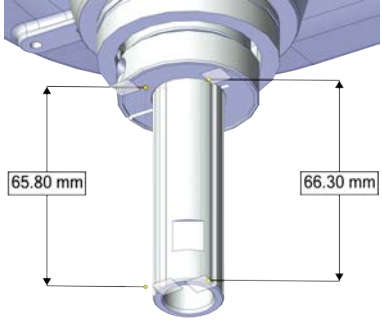
	Action	Note
2	<p>Refit the mechanical stopper to the ball screw at 30.5 mm position to the lower of the ball screw.</p> <p> Note</p> <p>For robots with protection class IP54 (option 3350-540) For robots with protection type Clean Room (option 3351-1) For 180 mm ball screw, refit the mechanical stopper to the ball screw at 65.8 mm position to the lower of the ball screw. For 300 mm ball screw, refit the mechanical stopper to the ball screw at 80.8 mm position to the lower of the ball screw.</p> <p> Tip</p> <p>Make sure that the limit block opening gap is aligned with the ball screw origin point.</p> <p> CAUTION</p> <p>If the ball screw nut or ball screw spline nut go out of the screw shaft, the ball screw is destroyed. Be careful when you do any work that may cause this.</p> <p> Note</p> <p>Be careful with the orientation of the mechanical stopper. The flat side is on the upper side.</p>	 <p>xx1800002861</p> <p>For robots with protection class IP30 (option 3350-300)</p>  <p>xx1900000144</p> <p>For robots with protection class IP54 (option 3350-540) For robots with protection type Clean Room (option 3351-1) For 180 mm ball screw</p>  <p>xx2100002425</p> <p>For 300 mm ball screw</p>

Continues on next page

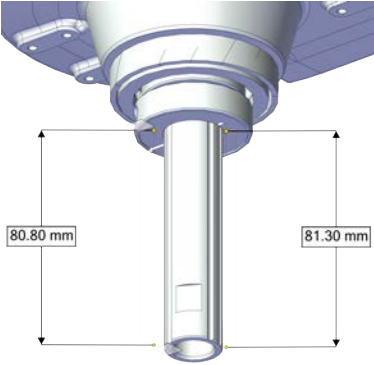
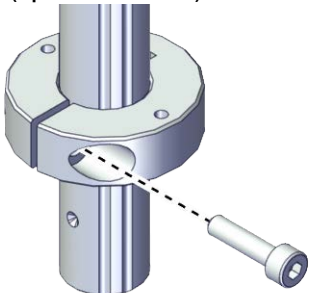
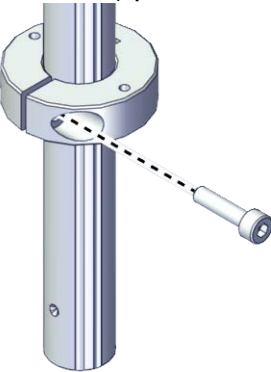
	Action	Note
		 <p>xx2100002426</p>
3	Refit the screw.	<p>Screws: Hex socket head cap screw M4x16 12.9 Lafre 2C2B/FC6.9 (1 pcs) Tightening torque: 6.5 Nm For robots with protection class IP30 (option 3350-300)</p>  <p>xx1800002860</p> <p>For robots with protection class IP54 (option 3350-540) For robots with protection type Clean Room (option 3351-1)</p>  <p>xx1900001642</p>

5 Repair



5.6.5 Replacing the ball screw

Continued

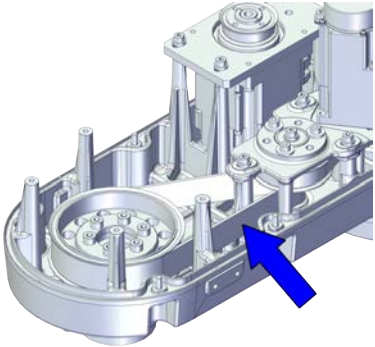
Refitting the axis-4 second timing belt to the pulley

	Action	Note
1	<p>For robots with protection type Clean Room: Clean the joints that have been opened and wipe the parts free from particles with spirit on a lint free. See Cut the paint or surface on the robot before replacing parts on page 118</p> <p> Note</p> <p>After all repair work, wipe the Clean Room robot free from particles with spirit on a lint free cloth.</p>	
2	<p>Refit the belt to the pulley. Ensure that the belt runs correctly in the grooves.</p>	<p>Timing belt, A4-2: 3HAC070471-001</p>  <p>xx2100001086</p>



Fastening the ball screw flange

	Action	Note
1	<p> DANGER</p> <p>Make sure that all supplies for electrical power, hydraulic pressure, and air pressure are turned off.</p>	
2	<p> CAUTION</p> <p>For robots with protection type Clean Room Always cut the paint with a knife and grind the paint edge when disassembling parts of the robot! See Cut the paint or surface on the robot before replacing parts on page 118.</p>	
3	<p> DANGER</p> <p>Make sure that the ball screw is supported with something. The sudden drop of the ball screw due the lost of the axis-3 motor may cause danger.</p>	

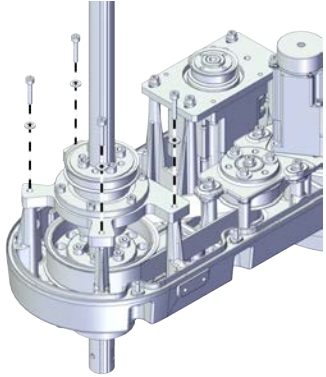
Continues on next page

	Action	Note
4	Tighten the screws of the ball screw flange.	 <p data-bbox="1054 705 1173 728">xx2100001082</p>

Fastening the transmission module screws and tension axis-4-2 timing belt



	Action	Note
1	 <p data-bbox="603 907 710 936">DANGER</p> <p data-bbox="507 967 1038 1048">Make sure that all supplies for electrical power, hydraulic pressure, and air pressure are turned off.</p>	
2	 <p data-bbox="603 1108 715 1137">CAUTION</p> <p data-bbox="507 1167 1050 1310">For robots with protection type Clean Room Always cut the paint with a knife and grind the paint edge when disassembling parts of the robot! See Cut the paint or surface on the robot before replacing parts on page 118.</p>	
3	 <p data-bbox="603 1366 710 1395">DANGER</p> <p data-bbox="507 1426 1050 1547">Make sure that the ball screw is supported with something. The sudden drop of the ball screw due the lost of the axis-3 motor may cause danger.</p>	

Continues on next page

5 Repair

5.6.5 Replacing the ball screw

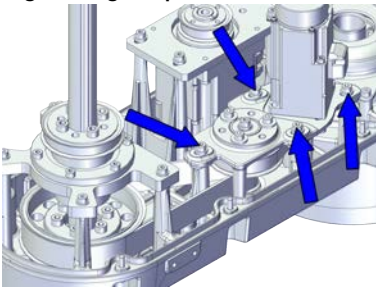
Continued

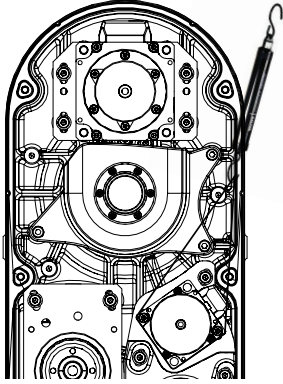
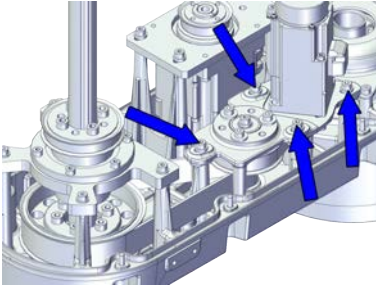
	Action	Note
4	Refit the screws of the transmission module without fully tightened.	<p>Screws: Hex socket head cap screw M4x20 12.9 Lafre 2C2B/FC6.9 (4 pcs) Washers: Plain washer machining 4.2x9x2 steel (4 pcs) Tightening torque: 2.6 Nm \pm10%</p>  <p>xx2100001087</p>
5	Hang a strong strap to the motor.	
6	<p>Use a handheld dynamometer hooking to the strap and pull the dynamometer to make the tension falling in the allowed force range.</p> <p> Note</p> <p>During the measurement, make sure that all interferences that may affect the force are removed. Pay attention to the force application direction.</p>	<p>Used belt: 100 New belt:240</p>  <p>xx2100001127</p>
7	Fasten the screws to the recommended tightening torque.	<p>Tightening torque: 2.6 Nm \pm10%</p>  <p>xx2100001087</p>
8	Use a sonic tension meter to measure the timing belt tension.	<p>Used belt: 202 New belt:180</p>
9	If the timing belt tension does not meet the requirement, loosen the motor screws and readjust.	

Continues on next page

Refitting the axis-3 timing belt

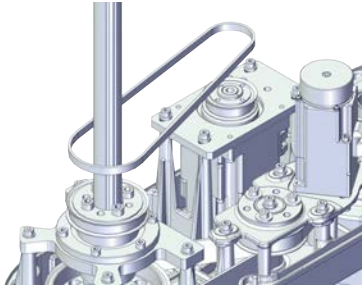
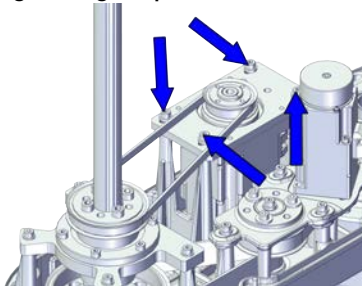
	Action	Note
1	<p>For robots with protection type Clean Room: Clean the joints that have been opened and wipe the parts free from particles with spirit on a lint free. See Cut the paint or surface on the robot before replacing parts on page 118</p> <p> Note</p> <p>After all repair work, wipe the Clean Room robot free from particles with spirit on a lint free cloth.</p>	
2	<p>Refit the timing belt to the pulley on the ball screw and the motor. Ensure that the belt runs correctly in the grooves.</p>	<p>Timing belt A3: 3HAC070464-001</p>  <p>xx2100001079</p>
3	<p>Secure the screws and washers without fully tightened.</p>	<p>Screws: Hex socket head cap screw M4x16 12.9 Lafre 2C2B/FC6.9 (4 pcs) Washers: Plain washer machining 4.2x9x2 steel (4 pcs) Tightening torque: 2.6 Nm ±10%</p>  <p>xx2100001078</p>
4	<p>Hang a strap to the hook on the motor.</p>	

Continues on next page

5 Repair

5.6.5 Replacing the ball screw

Continued

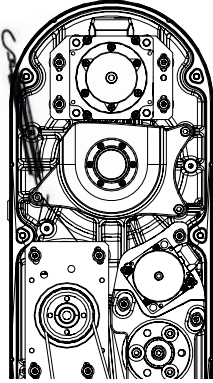

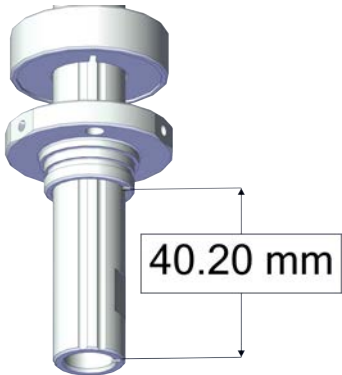

	Action	Note
5	<p>Use a handheld dynamometer hooking to the strap and pull the dynamometer to make the tension falling in the allowed force range.</p> <p> Note</p> <p>During the measurement, make sure that all interferences that may affect the force are removed. Pay attention to the force application direction.</p>	<p>Used belt: 36.6 New belt:40</p>  <p>xx2100001126</p>
6	Use a sonic tension meter to measure the timing belt tension.	Used belt: 139 New belt:110
7	If the timing belt tension does not meet the requirement, loosen the motor screws and readjust.	

For Clean Room/ IP54 robots

Refitting the shaft for Clean Room/ IP54 robots

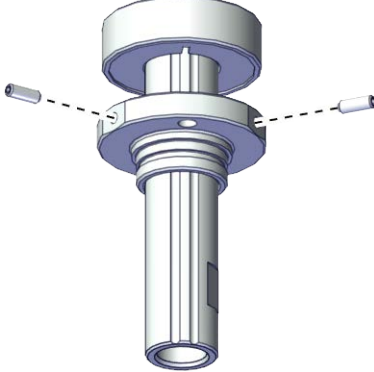
	Action	Note
1	<p>For robots with protection type Clean Room: Clean the joints that have been opened and wipe the parts free from particles with spirit on a lint free. See Cut the paint or surface on the robot before replacing parts on page 118</p> <p> Note</p> <p>After all repair work, wipe the Clean Room robot free from particles with spirit on a lint free cloth.</p>	
2	<p>For robots with protection class IP54 (option 3350-540) For robots with protection type Clean Room (option 3351-1) Install the shaft to the ball screw at 40.2 mm position to the lower of the ball screw.</p>	 <p>xx1900001617</p>

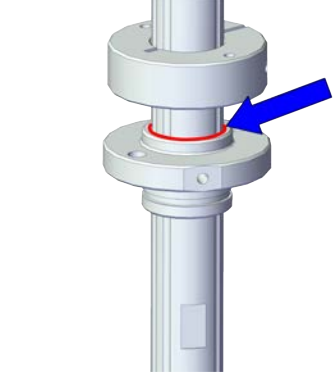
Continues on next page

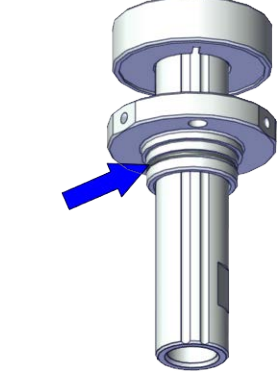
	Action	Note
3	<p>For robots with protection class IP54 (option 3350-540) For robots with protection type Clean Room (option 3351-1) Secure the shaft to the ball screw with the screws.</p>	<p>Screws: Hexagon socket set screws with flat point, ISO 4026 stainless steel M3x8 (2 pcs) Tightening torque: 0.4 Nm ±10%</p>  <p>xx1900001616</p>
4	<p>For robots with protection class IP54 (option 3350-540) Apply the glue to the upper contacted zone between the shaft and the ball screw.</p> <p> Note Fulfill the gaps on the ball screw in this contacted zone to make a sealing structure.</p>	 <p>xx1900001805</p>
5	<p>For robots with protection class IP54 (option 3350-540) For robots with protection type Clean Room (option 3351-1) Insert the O-ring to the shaft.</p> <p> Note Replace the o-ring if needed.</p>	 <p>xx1900001615</p>

Continues on next page

5 Repair



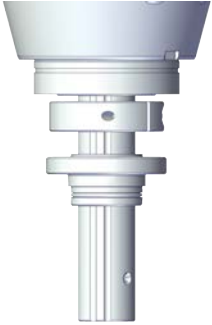

5.6.5 Replacing the ball screw

Continued

Refitting the lower bellow to outer arm

	Action	Note
1	<p>For robots with protection type Clean Room: Clean the joints that have been opened and wipe the parts free from particles with spirit on a lint free. See Cut the paint or surface on the robot before replacing parts on page 118</p> <p> Note</p> <p>After all repair work, wipe the Clean Room robot free from particles with spirit on a lint free cloth.</p>	
2	<p>For robots with protection class IP54 (option 3350-540) Apply the glue to the outer arm.</p>	 xx2100002409
3	<p>For robots with protection class IP54 (option 3350-540) For robots with protection type Clean Room (option 3351-1) Install the bellow to the shaft.</p>	

Continues on next page

	Action	Note
4	<p>For robots with protection class IP54 (option 3350-540)</p> <p>For robots with protection type Clean Room (option 3351-1)</p> <p>Pull the upper end of the bellow to the outer arm.</p> <p> Tip</p> <p>For robots with protection class IP54 (option 3350-540)</p> <p>Hold the bellow for a little while until it's attached to the housing.</p>	<p>Tightening torque: 2.5 Nm \pm10%</p> 
5	<p>For robots with protection class IP54 (option 3350-540)</p> <p>Install the bellow gaskets to the bellow.</p> <p> Tip</p> <p>The angle between the gap on the bellow gasket and gap on the inner bellow gasket should be 90 degrees.</p>	<p>xx2100002408</p>
6	<p>For robots with protection class IP54 (option 3350-540)</p> <p>For robots with protection type Clean Room (option 3351-1)</p> <p>Secure them with the clamp.</p> <p> Tip</p> <p>The opening part of the clamp should be in the opposite position to the gap on the bellow gasket.</p>	

Refitting the lower cover and the flange with bearing

	Action	Note
1	<p>For robots with protection type Clean Room:</p> <p>Clean the joints that have been opened and wipe the parts free from particles with spirit on a lint free. See Cut the paint or surface on the robot before replacing parts on page 118</p> <p> Note</p> <p>After all repair work, wipe the Clean Room robot free from particles with spirit on a lint free cloth.</p>	

Continues on next page

5 Repair

5.6.5 Replacing the ball screw

Continued

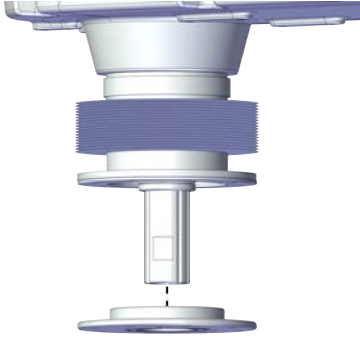
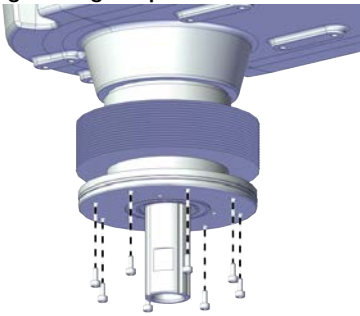
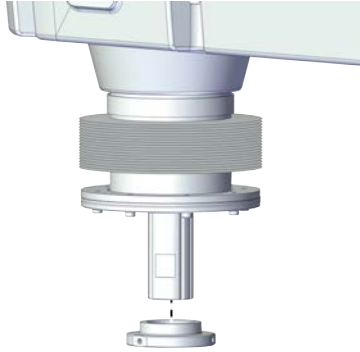
	Action	Note
2	<p>For robots with protection class IP54 (option 3350-540)</p> <p>For robots with protection type Clean Room (option 3351-1)</p> <p>Install the flange with bearing to the shaft.</p>	 <p>xx2100002407</p>
3	<p>For robots with protection class IP54 (option 3350-540)</p> <p>For robots with protection type Clean Room (option 3351-1)</p> <p>Refit the screws to the flange with bearing.</p>	<p>Screws: Hex socket head cap screw M2.5x6 12.9 Lafre 2C2B/FC6.9 (8 pcs)</p> <p>Tightening torque: 0.8 Nm \pm10%</p>  <p>xx2100002406</p>
4	<p>For robots with protection class IP54 (option 3350-540)</p> <p>For robots with protection type Clean Room (option 3351-1)</p> <p>Refit the lower cover to the ball screw.</p>	 <p>xx2100002405</p>

Continues on next page

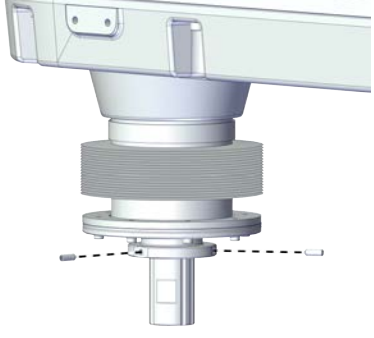
	Action	Note
5	<p>For robots with protection class IP54 (option 3350-540) For robots with protection type Clean Room (option 3351-1) Refit the locking screws.</p>	<p>Screws: Hexagon socket set screws with flat point, ISO 4026 stainless steel M3x8 (2 pcs) Tightening torque: 0.4 Nm ±10%</p>  <p>xx2100002404</p>



Refitting the cover of the outer arm

	Action	Note
1	<p>For robots with protection type Clean Room: Clean the joints that have been opened and wipe the parts free from particles with spirit on a lint free. See Cut the paint or surface on the robot before replacing parts on page 118</p> <p> Note</p> <p>After all repair work, wipe the Clean Room robot free from particles with spirit on a lint free cloth.</p>	

5 Repair

5.6.5 Replacing the ball screw

Continued

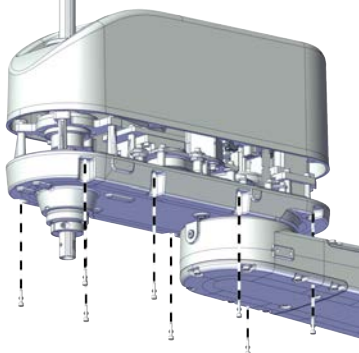
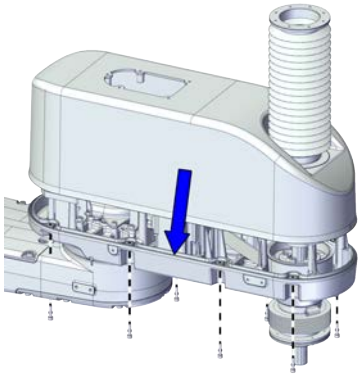



	Action	Note
2	<p>Refit the cover.</p> <p> Note</p> <p>For robots with protection class IP54 (option 3350-540)</p> <p>For robots with protection type Clean Room (option 3351-1)</p> <p>Refit the cover with bellow.</p> <p>Check the gasket for the outer arm cover.</p> <p> Tip</p> <p>Replace the gasket if needed.</p> <p> CAUTION</p> <p>The gasket is in the outer arm.</p>	<p>Screw: Hex socket head cap screw M4x16 12.9 Lafre 2C2B/FC6.9 (8 pcs)</p> <p>Tightening torque: 2 Nm \pm10%</p> <p>For robots with protection class IP30 (option 3350-300)</p>  <p>xx210000933</p>
3	<p>Refit the screws.</p>	<p>For robots with protection class IP54 (option 3350-540)</p> <p>For robots with protection type Clean Room (option 3351-1)</p>  <p>xx2100002427</p>

For Clean Room/ IP54 robots

Refitting the extension shaft for Clean Room/ IP54 robots

	Action	Note
1	<p>For robots with protection type Clean Room:</p> <p>Clean the joints that have been opened and wipe the parts free from particles with spirit on a lint free. See Cut the paint or surface on the robot before replacing parts on page 118</p> <p> Note</p> <p>After all repair work, wipe the Clean Room robot free from particles with spirit on a lint free cloth.</p>	

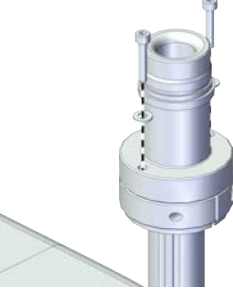
Continues on next page

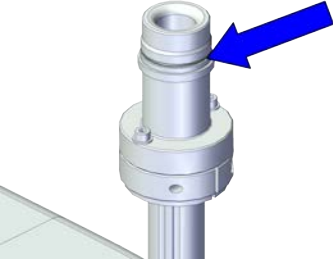
	Action	Note
2	<p>For robots with protection class IP54 (option 3350-540) For robots with protection type Clean Room (option 3351-1) Install the extension shaft to the ball screw on the upper side of the mechanical stopper.</p> <p> Note</p> <p>For robots with protection class IP54 (option 3350-540) Check the gasket for the extension shaft and replace it if needed.</p>	 <p>xx2100002421</p>
3	<p>For robots with protection class IP54 (option 3350-540) For robots with protection type Clean Room (option 3351-1) Secure the extension shaft to the mechanical stopper with the screws.</p>	<p>Screws: Hex socket head cap screw M3x16 12.9 Lafre 2C2B/FC6.9 (2 pcs) Tightening torque: 1.2 Nm ±10%</p>  <p>xx2100002420</p>
4	<p>For robots with protection class IP54 (option 3350-540) For robots with protection type Clean Room (option 3351-1) Insert the O-ring to the extension shaft.</p> <p> Note</p> <p>Replace the o-ring if needed.</p>	 <p>xx2100002419</p>



Continues on next page

5 Repair

5.6.5 Replacing the ball screw

Continued

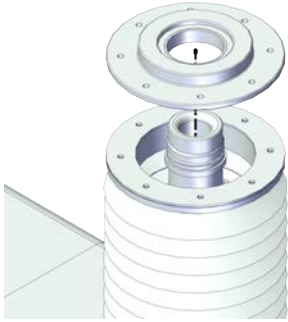
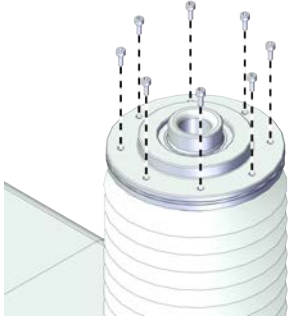
Refitting the top cover and the flange with bearing

	Action	Note
1	<p>For robots with protection type Clean Room: Clean the joints that have been opened and wipe the parts free from particles with spirit on a lint free. See Cut the paint or surface on the robot before replacing parts on page 118</p> <p> Note</p> <p>After all repair work, wipe the Clean Room robot free from particles with spirit on a lint free cloth.</p>	
2	<p>For robots with protection class IP54 (option 3350-540) For robots with protection type Clean Room (option 3351-1) Install the flange with bearing to the extension shaft.</p>	 <p>xx2100002402</p>
3	<p>For robots with protection class IP54 (option 3350-540) For robots with protection type Clean Room (option 3351-1) Refit the screws to the flange with bearing.</p>	<p>Screws: Hex socket head cap screw M2.5x6 12.9 Lafre 2C2B/FC6.9 (8 pcs) Tightening torque: 0.8 Nm ±10%</p>  <p>xx2100002401</p>
4	<p>For robots with protection class IP54 (option 3350-540) For robots with protection type Clean Room (option 3351-1) Refit the top cover to the ball screw.</p> <p> Tip</p> <p>The top surface of the cover should be flush with the top end of the ball screw.</p>	 <p>xx2100002399</p>

Continues on next page

5.6.5 Replacing the ball screw
Continued

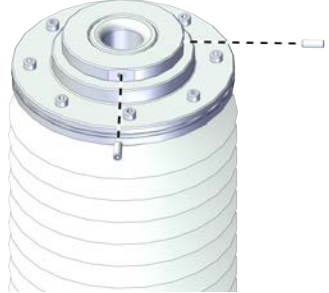
	Action	Note
5	<p>For robots with protection class IP54 (option 3350-540) For robots with protection type Clean Room (option 3351-1) Refit the locking screws.</p>	<p>Screws: Hexagon socket set screws with flat point, ISO 4026 stainless steel M3x8 (2 pcs) Tightening torque: 0.4 Nm ±10%</p>  <p>xx2100002398</p>

Securing the process hub to outer arm cover



	Action	Note
1	<p>For robots with protection type Clean Room: Clean the joints that have been opened and wipe the parts free from particles with spirit on a lint free. See Cut the paint or surface on the robot before replacing parts on page 118</p> <p> Note</p> <p>After all repair work, wipe the Clean Room robot free from particles with spirit on a lint free cloth.</p>	
2	Insert the process hub from the outer arm cover.	

Continues on next page

5 Repair

5.6.5 Replacing the ball screw

Continued

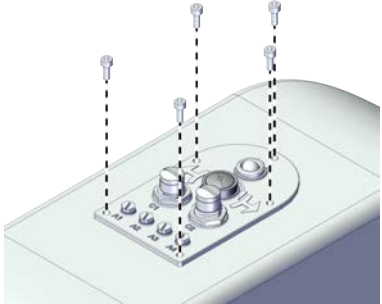
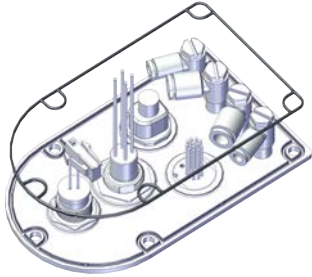
	Action	Note
3	<p>Secure the process hub to the outer arm cover with the screws.</p> <p> Note</p> <p>For robots with protection class IP54 (option 3350-540) For robots with protection type Clean Room (option 3351-1) Check the gasket for the process hub.</p> <p> Tip</p> <p>Replace the gasket if needed.</p> <p> CAUTION</p> <p>Be aware of the cabling that is attached to the cover! The cover can not be removed completely until the connectors are disconnected, as shown in following steps.</p>	<p>Screws: Hex socket head cap screw M4x10 12.9 Lafre 2C2B/FC6.9 (5 pcs) Tightening torque: 2.6 Nm±10% For robots with protection class IP30 (option 3350-300)</p>  <p>xx2100000932</p> <p>For robots with protection class IP54 (option 3350-540) For robots with protection type Clean Room (option 3351-1)</p>  <p>xx2100002438</p>

Concluding procedure

	Action	Note
1	<p>For robots with protection type Clean Room: Seal and paint the joints that have been opened. See Cut the paint or surface on the robot before replacing parts on page 118</p> <p> Note</p> <p>After all repair work, wipe the Clean Room robot free from particles with spirit on a lint free cloth.</p>	
2	Recalibrate the robot.	Calibration is detailed in section Calibration on page 945 .

Continues on next page

	Action	Note
3	 DANGER Make sure all safety requirements are met when performing the first test run.	

5 Repair

5.6.6 Replacing the axis-2 timing belt

5.6.6 Replacing the axis-2 timing belt

Location of the axis-2 timing belt

The axis-2 timing belt is located as shown in the figure.

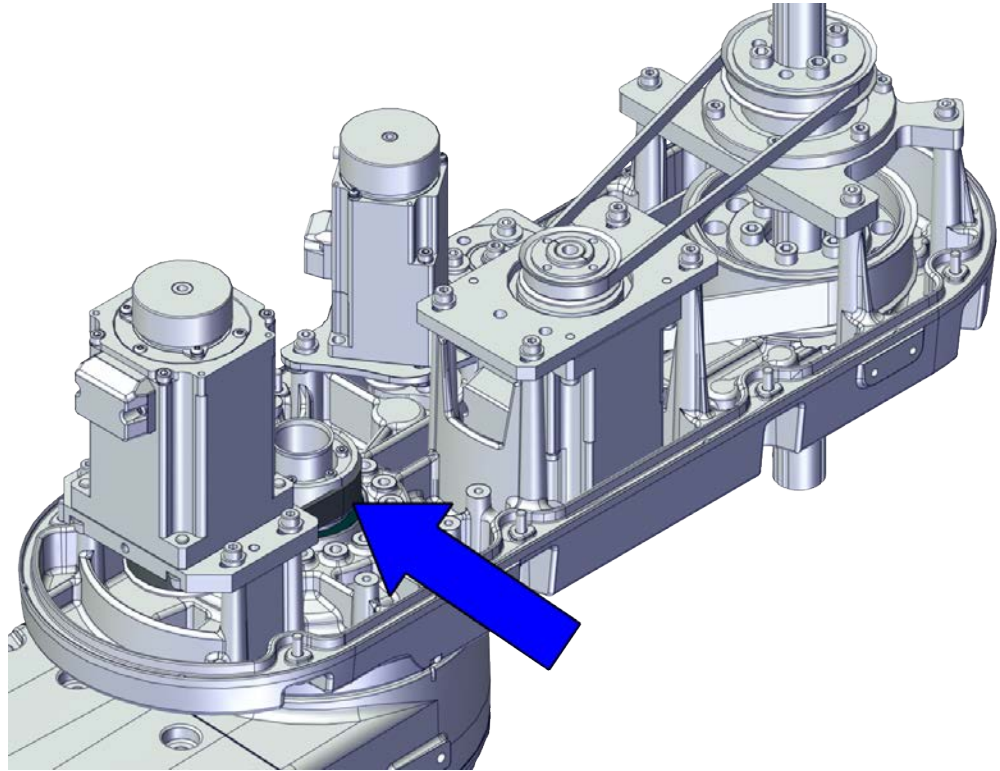

xx2100001024

Required spare parts



Note

The spare part numbers that are listed in the table can be out of date. See the latest spare parts of the IRB 920 via myABB Business Portal, www.abb.com/myABB.

Spare part	Article number	Note
Timing belt A2	3HAC061861-001	

Required tools and equipment

Equipment	Article number	Note
Standard toolkit	-	Content is defined in section Standard toolkit on page 996 .
Calibration toolbox, Axis Calibration	3HAC055412-001	Delivered as a set of calibration tools. Required if Axis Calibration is the valid calibration method for the robot.

Continues on next page

Equipment	Article number	Note
Sonic tension meter	-	Used for measuring the timing belt tension.
Handheld dynamometer	-	Used for measuring the timing belt tension.

Required consumables

Consumable	Article number	Note
Cable straps	-	
Grease	3HAC029132-001	FM 222

Deciding calibration routine

Decide which calibration routine to be used, based on the information in the table. Depending on which routine is chosen, action might be required prior to beginning the repair work of the robot, see the table.

	Action	Note
1	<p>Decide which calibration routine to use for calibrating the robot.</p> <ul style="list-style-type: none"> Reference calibration. External cable packages (DressPack) and tools can stay fitted on the robot. Fine calibration. All external cable packages (DressPack) and tools must be removed from the robot. 	
	<p>If the robot is to be calibrated with reference calibration:</p> <p>Find previous reference values for the axis or create new reference values. These values are to be used after the repair procedure is completed, for calibration of the robot.</p> <p>If no previous reference values exist, and no new reference values can be created, then reference calibration is not possible.</p>	<p>Follow the instructions given in the reference calibration routine on the FlexPendant to create reference values.</p> <p>Creating new values requires possibility to move the robot.</p> <p>Read more about reference calibration for Axis Calibration in Reference calibration routine on page 957.</p>
	<p>If the robot is to be calibrated with fine calibration:</p> <p>Remove all external cable packages (DressPack) and tools from the robot.</p>	

Removing the axis-2 timing belt

Use these procedures to remove the axis-2 timing belt.

Preparations before removing the axis-2 timing belt



	Action	Note
1	Decide which calibration routine to use, and take actions accordingly prior to beginning the repair procedure.	

Continues on next page

5 Repair

5.6.6 Replacing the axis-2 timing belt

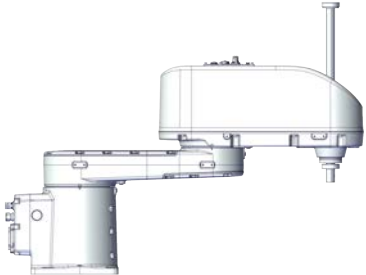

Continued

	Action	Note
2	<p>If there is no enough space for the maintenance work, remove the robot from the wall and place it on the maintenance bracket.</p> <p> CAUTION</p> <p>Do not lay down the robot during the transportation, always keep it straight. If the robot lay down in any situation, the grease may come out from gearbox.</p>	
3	<p>Jog all axes to zero position.</p>	 <p>xx2100000930</p>
4	<p> DANGER</p> <p>Turn off all:</p> <ul style="list-style-type: none"> • electric power supply • hydraulic pressure supply • air pressure supply <p>to the robot, before entering the safeguarded space.</p>	
5	<p> CAUTION</p> <p>For robots with protection type Clean Room Always cut the paint with a knife and grind the paint edge when disassembling parts of the robot! See Cut the paint or surface on the robot before replacing parts on page 118.</p>	

Removing the process hub screws

	Action	Note
1	<p> DANGER</p> <p>Make sure that all supplies for electrical power, hydraulic pressure, and air pressure are turned off.</p>	

Continues on next page

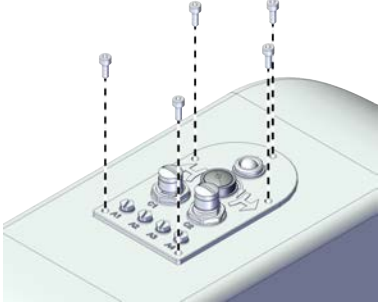
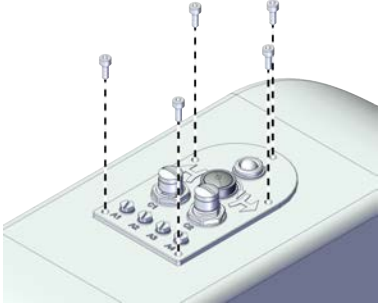
	Action	Note
2	<p> CAUTION</p> <p>For robots with protection type Clean Room Always cut the paint with a knife and grind the paint edge when disassembling parts of the robot! See <i>Cut the paint or surface on the robot before replacing parts on page 118.</i></p>	
3	<p>Remove the screws on the process hub.</p> <p> Note</p> <p>For robots with protection class IP54 (option 3350-540) For robots with protection type Clean Room (option 3351-1) Remove the screws on the process hub and take out the gasket.</p> <p> Tip</p> <p>Check the gasket and replace it if needed.</p>	<p>For robots with protection class IP30</p>  <p>xx2100000932</p> <p>For robots with protection class IP54 (option 3350-540) For robots with protection type Clean Room (option 3351-1)</p>  <p>xx2100000932</p>
4	Insert the process hub to the outer arm.	

For Clean Room/ IP54 robots

Removing the top cover and the flange with bearing



	Action	Note
1	<p> DANGER</p> <p>Make sure that all supplies for electrical power, hydraulic pressure, and air pressure are turned off.</p>	

Continues on next page

5 Repair

5.6.6 Replacing the axis-2 timing belt

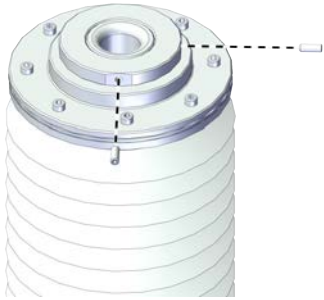
Continued

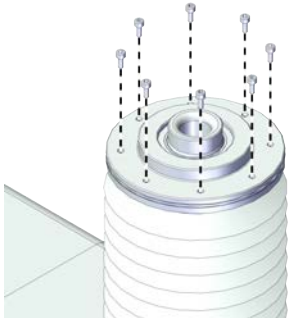

	Action	Note
2	<p> CAUTION</p> <p>For robots with protection type Clean Room Always cut the paint with a knife and grind the paint edge when disassembling parts of the robot! See Cut the paint or surface on the robot before replacing parts on page 118.</p>	
3	<p>For robots with protection class IP54 (option 3350-540) For robots with protection type Clean Room (option 3351-1) Loose the locking screws.</p>	 <p>xx2100002398</p>
4	<p>For robots with protection class IP54 (option 3350-540) For robots with protection type Clean Room (option 3351-1) Remove the top cover from the ball screw.</p>	 <p>xx2100002399</p>
5	<p>For robots with protection class IP54 (option 3350-540) For robots with protection type Clean Room (option 3351-1) Remove the screws on the flange with bearing.</p>	 <p>xx2100002401</p>

Continues on next page

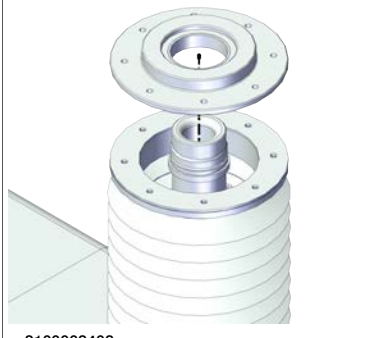
5.6.6 Replacing the axis-2 timing belt
Continued

	Action	Note
6	<p>For robots with protection class IP54 (option 3350-540) For robots with protection type Clean Room (option 3351-1) Remove the flange with bearing.</p>	 <p>xx2100002402</p>

Removing the cover of the outer arm



	Action	Note
1	<p> DANGER</p> <p>Make sure that all supplies for electrical power, hydraulic pressure, and air pressure are turned off.</p>	
2	<p> CAUTION</p> <p>For robots with protection type Clean Room Always cut the paint with a knife and grind the paint edge when disassembling parts of the robot! See Cut the paint or surface on the robot before replacing parts on page 118.</p>	

Continues on next page



5 Repair

5.6.6 Replacing the axis-2 timing belt

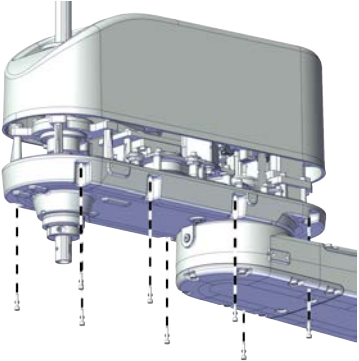
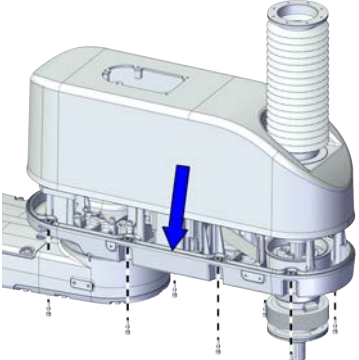



Continued

	Action	Note
3	<p>Remove the screws on the cover of the outer arm and remove the cover.</p> <p> Note</p> <p>For robots with protection class IP54 (option 3350-540) For robots with protection type Clean Room (option 3351-1) Remove the cover with bellow and housing.</p> <p> Note</p> <p>The bellow does not need to be removed separately.</p> <p> Tip</p> <p>Check the gasket and replace it if needed.</p>	<p>For robots with protection class IP30</p>  <p>xx210000933</p> <p>For robots with protection class IP54 (option 3350-540) For robots with protection type Clean Room (option 3351-1)</p>  <p>xx2100002427</p>

Disconnecting the air hoses, C1 cabling and C2 cabling (if equipped)

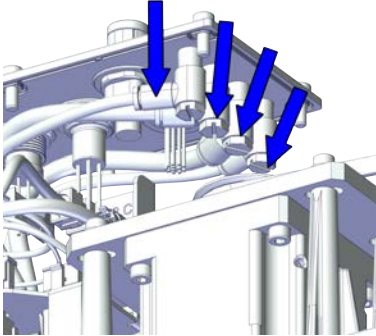
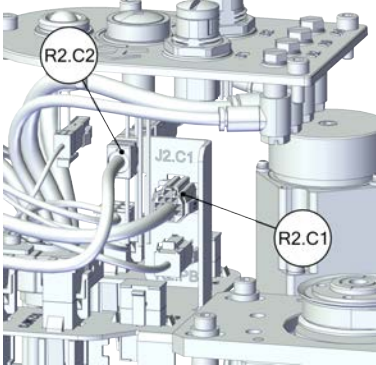
	Action	Note
1	<p> DANGER</p> <p>Make sure that all supplies for electrical power, hydraulic pressure, and air pressure are turned off.</p>	
2	<p> CAUTION</p> <p>For robots with protection type Clean Room Always cut the paint with a knife and grind the paint edge when disassembling parts of the robot! See Cut the paint or surface on the robot before replacing parts on page 118.</p>	

Continues on next page

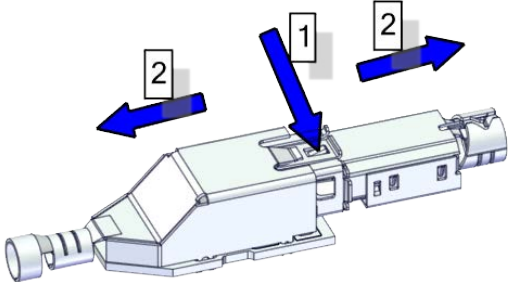
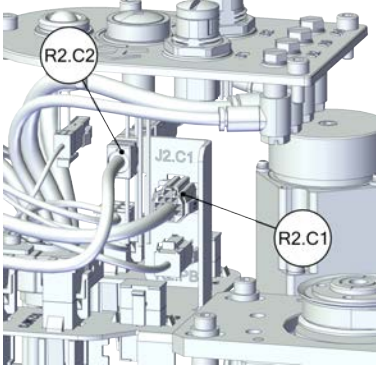
	Action	Note
3	<p>Disconnect the air hoses from the L-shaped connectors.</p>	 <p>xx2100001032</p>
4	<p>For robots with C1 cabling Disconnect the connector.</p> <ul style="list-style-type: none"> • R2.C1 	 <p>xx2100001033</p>
5	<p>For robots with C2 cabling Disconnect the connector.</p> <ul style="list-style-type: none"> • R1.C2 <p> Tip</p> <p>Cut the cable straps for the R1.C2 at the same time.</p> <p> Tip</p> <p>Take photos of the connector and cable position before disconnecting them, to have as a reference when reconnecting.</p> <p> Tip</p> <p>The connector clip has to be pressed (1) and pushed forward (2) to separate the R1.C2 (for C2 cabling).</p>  <p>xx1800002943</p>	 <p>xx2100001033</p>



5 Repair

5.6.6 Replacing the axis-2 timing belt

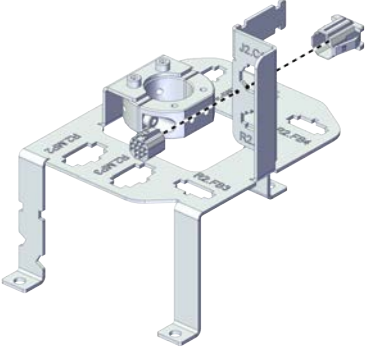
Continued

	Action	Note
6	<p>Snap loose and remove the female head of the connectors from the bracket.</p> <p> Note</p> <p>The harness are not visible due to the cleanliness requirements of the illustration. They are still existing inside the cable ferrule in the actual situation.</p>	 <p>xx2100001034</p>

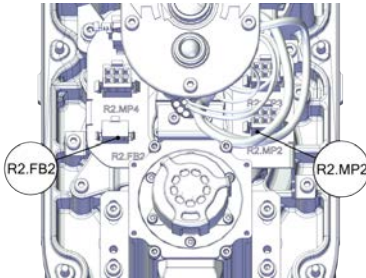

Disconnecting the connectors for axis-2 motor

	Action	Note
1	<p> DANGER</p> <p>Make sure that all supplies for electrical power, hydraulic pressure, and air pressure are turned off.</p>	
2	<p> CAUTION</p> <p>For robots with protection type Clean Room Always cut the paint with a knife and grind the paint edge when disassembling parts of the robot! See Cut the paint or surface on the robot before replacing parts on page 118.</p>	
3	<p>Disconnect the connectors.</p> <ul style="list-style-type: none"> • R2.MP2 • R2.FB2 	 <p>xx2100000934</p>

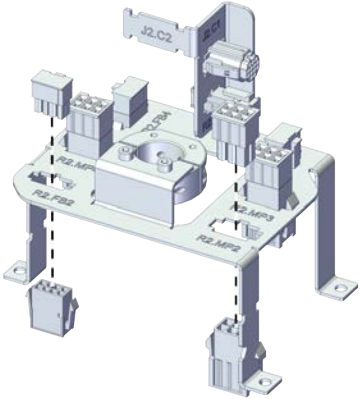
Continues on next page

	Action	Note
4	<p>Snap loose and remove the female head of the connectors from the bracket.</p> <p> Note</p> <p>The harness are not visible due to the cleanness requirements of the illustration. They are still existing inside the cable ferrule in the actual situation.</p>	 <p>xx2100000935</p>

Disconnecting the connectors for axis-3 motor

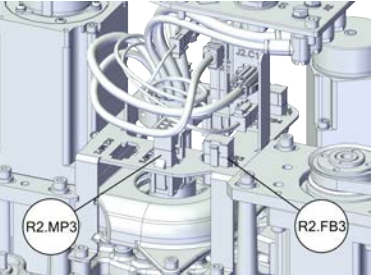
	Action	Note
1	<p> DANGER</p> <p>Make sure that all supplies for electrical power, hydraulic pressure, and air pressure are turned off.</p>	
2	<p> CAUTION</p> <p>For robots with protection type Clean Room</p> <p>Always cut the paint with a knife and grind the paint edge when disassembling parts of the robot! See Cut the paint or surface on the robot before replacing parts on page 118.</p>	
3	<p>Disconnect the connectors.</p> <ul style="list-style-type: none"> • R2.MP3 • R2.FB3 	 <p>xx2100000936</p>

Continues on next page



5 Repair

5.6.6 Replacing the axis-2 timing belt

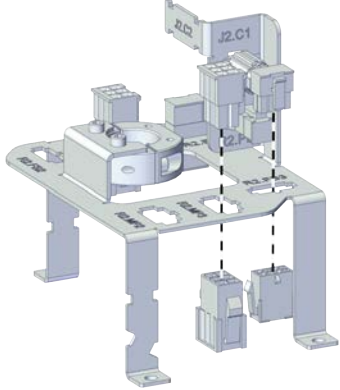
Continued



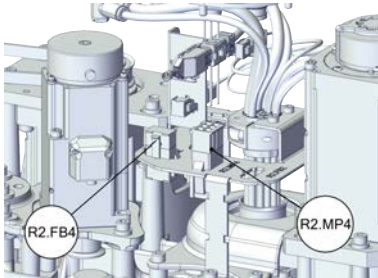

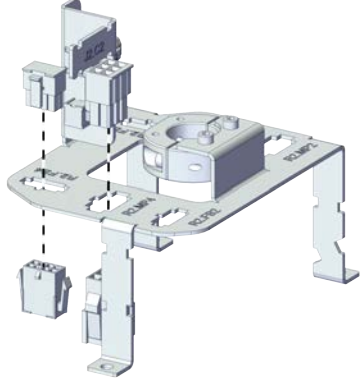
	Action	Note
4	<p>Snap loose and remove the female head of the connectors from the bracket.</p> <p> Note</p> <p>The harness are not visible due to the cleanness requirements of the illustration. They are still existing inside the cable ferrule in the actual situation.</p>	 <p>xx2100000937</p>

Disconnecting the connectors for axis-4 motor

	Action	Note
1	<p>For robots with protection type Clean Room: Clean the joints that have been opened and wipe the parts free from particles with spirit on a lint free. See Cut the paint or surface on the robot before replacing parts on page 118</p> <p> Note</p> <p>After all repair work, wipe the Clean Room robot free from particles with spirit on a lint free cloth.</p>	
2	<p>Disconnect the axis-4 motor connectors.</p> <ul style="list-style-type: none"> • R2.MP4 • R2.FB4 	 <p>xx2100000938</p>
3	<p>Snap loose and remove the female head of the connectors from the bracket.</p> <p> Note</p> <p>The harness are not visible due to the cleanness requirements of the illustration. They are still existing inside the cable ferrule in the actual situation.</p>	 <p>xx2100000939</p>

Continues on next page

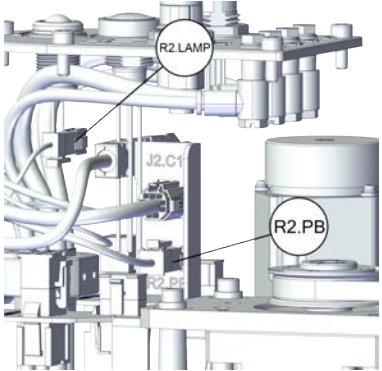
Disconnecting the connector for PB

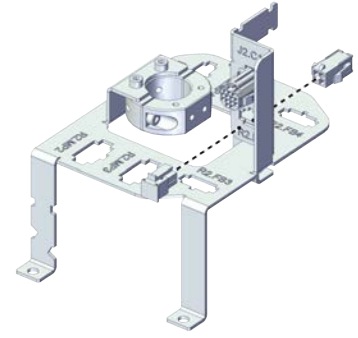
	Action	Note
1	 DANGER Make sure that all supplies for electrical power, hydraulic pressure, and air pressure are turned off.	
2	 CAUTION For robots with protection type Clean Room Always cut the paint with a knife and grind the paint edge when disassembling parts of the robot! See Cut the paint or surface on the robot before replacing parts on page 118 .	
3	Disconnect the connector. <ul style="list-style-type: none"> • R2.PB • R2.LAMP 	 <p>xx2100001030</p>
4	Snap loose and remove the female head of the connector from the bracket.  Note The harness are not visible due to the cleanliness requirements of the illustration. They are still existing inside the cable ferrule in the actual situation.	 <p>xx2100001031</p>

Pull out the process hub





	Action	Note
1	 DANGER Make sure that all supplies for electrical power, hydraulic pressure, and air pressure are turned off.	

Continues on next page



5 Repair

5.6.6 Replacing the axis-2 timing belt

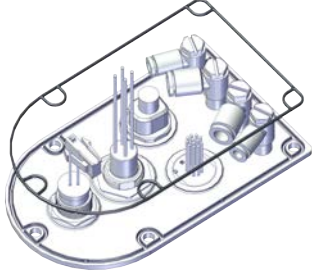
Continued



	Action	Note
2	 CAUTION For robots with protection type Clean Room Always cut the paint with a knife and grind the paint edge when disassembling parts of the robot! See Cut the paint or surface on the robot before replacing parts on page 118 .	
3	Take out the process hub.  Note For robots with protection class IP54 (option 3350-540) For robots with protection type Clean Room (option 3351-1) Check the gasket for the process hub.  Tip Replace the gasket if needed.  CAUTION Be aware of the cabling that is attached to the cover! The cover can not be removed completely until the connectors are disconnected, as shown in following steps.	For robots with protection class IP54 (option 3350-540) For robots with protection type Clean Room (option 3351-1)  xx2100002438

Removing the cable ferrule and bracket

	Action	Note
1	 DANGER Make sure that all supplies for electrical power, hydraulic pressure, and air pressure are turned off.	
2	 CAUTION For robots with protection type Clean Room Always cut the paint with a knife and grind the paint edge when disassembling parts of the robot! See Cut the paint or surface on the robot before replacing parts on page 118 .	

Continues on next page

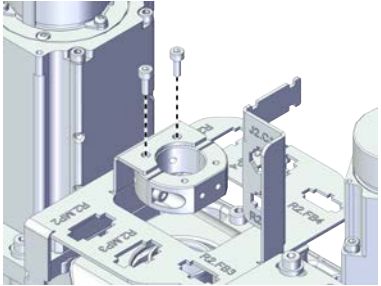
5.6.6 Replacing the axis-2 timing belt
Continued

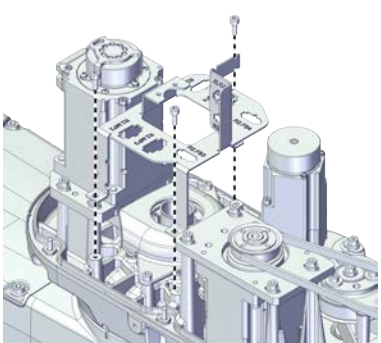
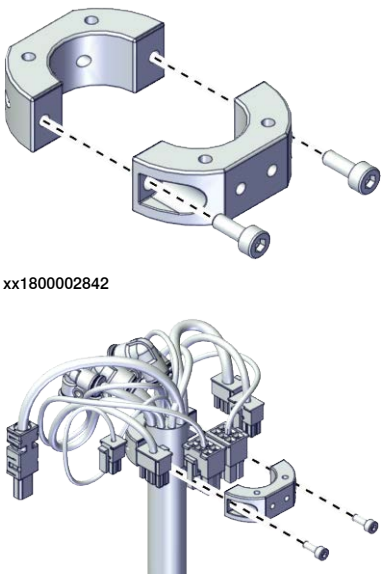
	Action	Note
3	<p>Remove the screws on the bracket to the cable ferrule to release the cable ferrule with cable.</p> <p> Note</p> <p>The harness are not visible due to the cleanness requirements of the illustration. They are still existing inside the cable ferrule in the actual situation.</p>	 <p>xx2100000940</p>
4	<p>Remove the screws on the bracket.</p> <p> Note</p> <p>The harness are not visible due to the cleanness requirements of the illustration. They are still existing inside the cable ferrule in the actual situation.</p>	 <p>xx2100000941</p>
5	<p>Remove the screws on the cable ferrule and take the cable ferrule out.</p>	 <p>xx1800002842</p> <p>xx1800002849</p>

Removing the gear-2 pulley protection cover

	Action	Note
1	<p> DANGER</p> <p>Make sure that all supplies for electrical power, hydraulic pressure, and air pressure are turned off.</p>	

Continues on next page



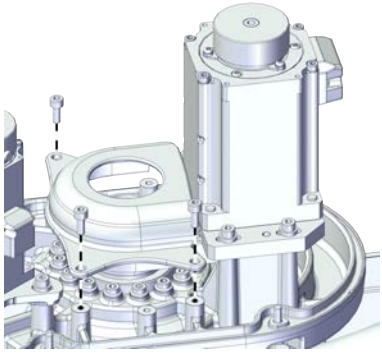

5 Repair

5.6.6 Replacing the axis-2 timing belt

Continued

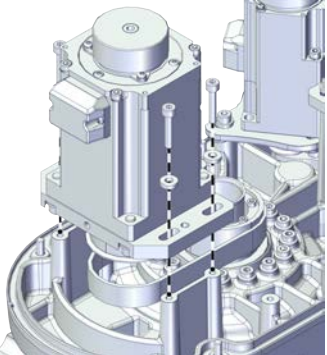

	Action	Note
2	 CAUTION For robots with protection type Clean Room Always cut the paint with a knife and grind the paint edge when disassembling parts of the robot! See Cut the paint or surface on the robot before replacing parts on page 118 .	
3	Remove the screws on the pulley protection cover to release the pulley protection cover.	 xx2100001047

Removing the axis-2 motor sub-assembly

	Action	Note
1	 DANGER Make sure that all supplies for electrical power, hydraulic pressure, and air pressure are turned off.	
2	 CAUTION For robots with protection type Clean Room Always cut the paint with a knife and grind the paint edge when disassembling parts of the robot! See Cut the paint or surface on the robot before replacing parts on page 118 .	
3	Remove the screws and washers.	 xx2100001046
4	Remove the motor.  Tip Move the internal harness out of the way.	

Continues on next page

Removing the axis-2 timing belt

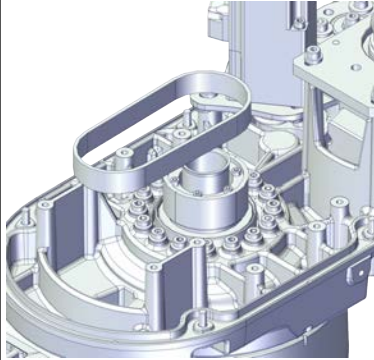
	Action	Note
1	 DANGER Make sure that all supplies for electrical power, hydraulic pressure, and air pressure are turned off.	
2	 CAUTION For robots with protection type Clean Room Always cut the paint with a knife and grind the paint edge when disassembling parts of the robot! See Cut the paint or surface on the robot before replacing parts on page 118 .	
3	Remove the timing belt from the outer arm.	 xx2100001048

Refitting the axis-2 timing belt

Use these procedures to refit the axis-2 timing belt.

Refitting the axis-2 motor sub-assembly



	Action	Note
1	For robots with protection type Clean Room: Clean the joints that have been opened and wipe the parts free from particles with spirit on a lint free. See Cut the paint or surface on the robot before replacing parts on page 118	
	 Note After all repair work, wipe the Clean Room robot free from particles with spirit on a lint free cloth.	

Continues on next page

5 Repair

5.6.6 Replacing the axis-2 timing belt

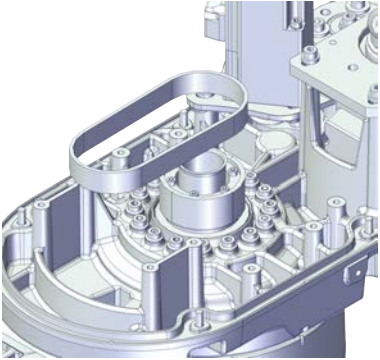
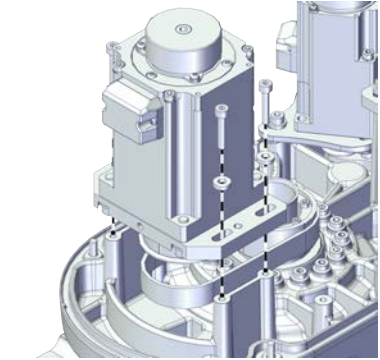
Continued

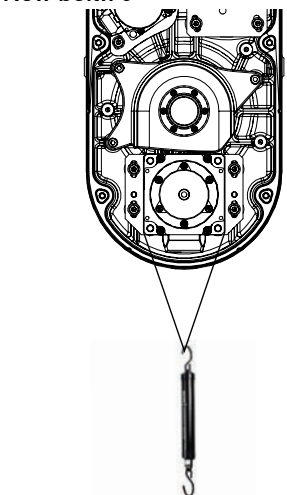
	Action	Note
2	Refit the axis-2 timing belt onto the pulley on the axis-2 gearbox.	 <p>xx2100001048</p>
3	Refit the motor and refit the timing belt to the motor. Ensure that the belt runs correctly in the grooves.	Screws: Hex socket head cap screw M4x20 12.9 Lafre 2C2B/FC6.9 (4 pcs)
4	Refit the screws and washers without fully tightened.	Washers: Plain washer machining 4.2x9x2 steel (4 pcs) Tightening torque: 2.3 Nm \pm 10%  <p>xx2100001046</p> <p>Timing belt A2: 3HAC061861-001</p>
5	Hang a strap to the motor.	
6	Use a handheld dynamometer hooking to the strap and pull the dynamometer to make the tension falling in the allowed force range.  Note During the measurement, make sure that all interferences that may affect the force are removed. Pay attention to the force application direction.  Tip If the ball screw will interfere with the handheld dynamometer, adjust the ball screw manually.	Used belt: 64.7 New belt:70  <p>xx2100001125</p>

Continues on next page

5.6.6 Replacing the axis-2 timing belt
Continued

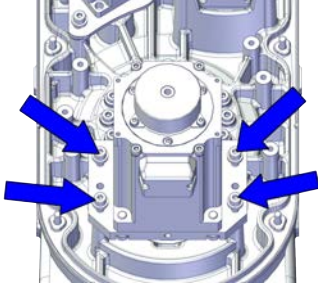
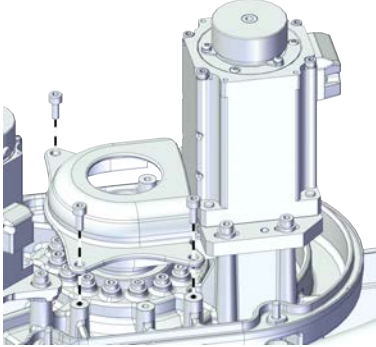
	Action	Note
7	Fasten the screws to the recommended tightening torque.	Tightening torque: 2.3 Nm ±10%  xx2100001176
8	Use a sonic tension meter to measure the timing belt tension.	Used belt: 315 New belt:260
9	If the timing belt tension does not meet the requirement, loosen the motor screws and readjust.	
10	Refit the pulley protection cover and secure with screws.	Screws: Hex socket head cap screw M4x10 12.9 Lafre 2C2B/FC6.9 (3 pcs) Tightening torque: 0.8 Nm  xx2100001047

Refitting the cable ferrule and bracket in the outer arm







	Action	Note
1	For robots with protection type Clean Room: Clean the joints that have been opened and wipe the parts free from particles with spirit on a lint free. See Cut the paint or surface on the robot before replacing parts on page 118  Note After all repair work, wipe the Clean Room robot free from particles with spirit on a lint free cloth.	
2	Lay the internal harness in a natural state without distortion.	

Continues on next page

5 Repair

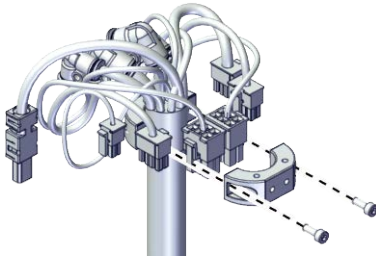

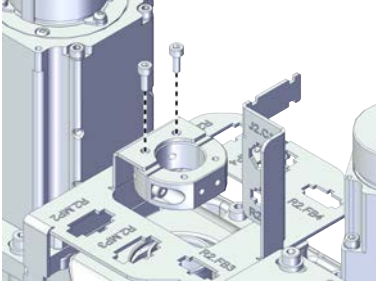



5.6.6 Replacing the axis-2 timing belt

Continued

	Action	Note
3	<p>Refit the cable ferrule and secure it with the screws.</p> <p> Tip</p> <p>The air hoses should face the process hub side.</p> <p> Tip</p> <p>The position with wrapped tape is the marked position for the cable ferrule.</p> <p> Tip</p> <p>Align all the cable ferrules so that the cable is in a natural bending position to avoid twisting.</p>	<p>Screws: Hex socket head cap screw M3x8 12.9 Lafre 2C2B/FC6.9 (2 pcs)</p> <p>Tightening torque: 1.2 Nm ±10%</p>  <p>xx1800002849</p>
4	<p>Secure the cable ferrule to the bracket.</p> <p> Tip</p> <p>Align all the cable ferrules so that the cable is in a natural bending position to avoid twisting.</p> <p> Note</p> <p>The harness are not visible due to the cleanness requirements of the illustration. They are still existing inside the cable ferrule in the actual situation.</p>	<p>Screws: Hex socket head cap screw M3x8 12.9 Lafre 2C2B/FC6.9 (2 pcs)</p> <p>Tightening torque: 1.2 Nm ±10%</p>  <p>xx2100000940</p>
5	<p>Refit the bracket without securing.</p> <p> Tip</p> <p>Do not secure it with the screws before the cable ferrule installed well.</p> <p> Note</p> <p>The harness are not visible due to the cleanness requirements of the illustration. They are still existing inside the cable ferrule in the actual situation.</p>	

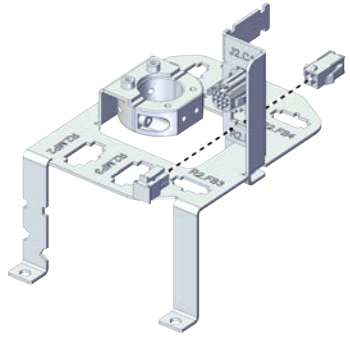
Continues on next page

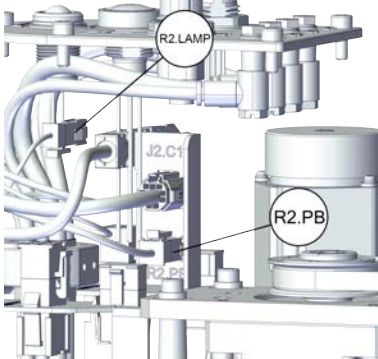
Reconnecting the connector for PB

	Action	Note
1	<p>For robots with protection type Clean Room: Clean the joints that have been opened and wipe the parts free from particles with spirit on a lint free. See Cut the paint or surface on the robot before replacing parts on page 118</p> <p> Note</p> <p>After all repair work, wipe the Clean Room robot free from particles with spirit on a lint free cloth.</p>	
2	<p>Insert the female head of the PB connector to the bracket accordingly.</p> <p> Tip</p> <p>The mistake proofing measure has been applied to the connectors, the connectors may be damaged if excessive force is used.</p> <p> Note</p> <p>The harness are not visible due to the cleanness requirements of the illustration. They are still existing inside the cable ferrule in the actual situation.</p>	 <p>xx2100001031</p>
3	<p>Reconnect the connector.</p> <ul style="list-style-type: none"> • R2.PB • R2.LAMP <p> Tip</p> <p>See the number markings on the connectors for help to find the corresponding connector.</p>	 <p>xx2100001030</p>
4	<p>Route and secure the cabling with cable straps if needed.</p> <p> CAUTION</p> <p>Correct cable routing is highly important. If the cables are routed incorrectly the cables can be damaged.</p>	







Continues on next page

5 Repair

5.6.6 Replacing the axis-2 timing belt

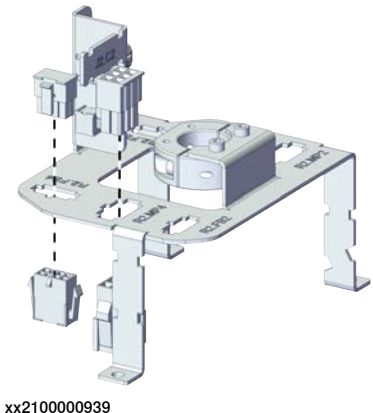

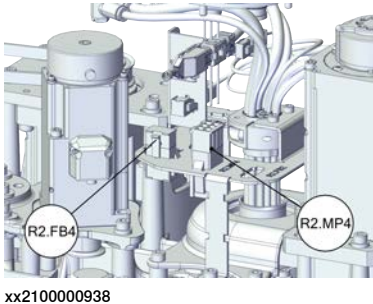



Continued

Reconnecting the connectors for axis-4 motor

	Action	Note
1	<p>For robots with protection type Clean Room: Clean the joints that have been opened and wipe the parts free from particles with spirit on a lint free. See Cut the paint or surface on the robot before replacing parts on page 118</p> <p> Note</p> <p>After all repair work, wipe the Clean Room robot free from particles with spirit on a lint free cloth.</p>	
	<p>Insert the female head of the connectors to the bracket accordingly.</p> <p> Tip</p> <p>The mistake proofing measure has been applied to the connectors, the connectors may be damaged if excessive force is used.</p> <p> Note</p> <p>The harness are not visible due to the cleanness requirements of the illustration. They are still existing inside the cable ferrule in the actual situation.</p>	 <p>xx210000939</p>
2	<p>Reconnect the connectors.</p> <ul style="list-style-type: none"> • R2.MP4 • R2.FB4 <p> Tip</p> <p>See the number markings on the connectors for help to find the corresponding connector.</p>	 <p>xx210000938</p>
3	<p>Route the cabling on the axis-4 motor.</p> <p> CAUTION</p> <p>Correct cable routing is highly important. If the cables are routed and secured incorrectly the cables can be damaged.</p>	

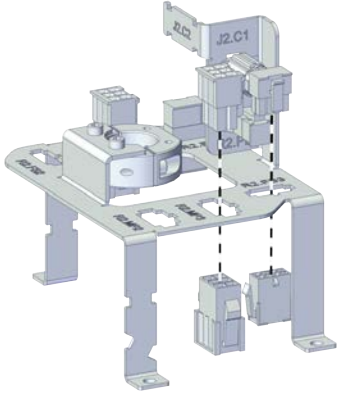
Continues on next page

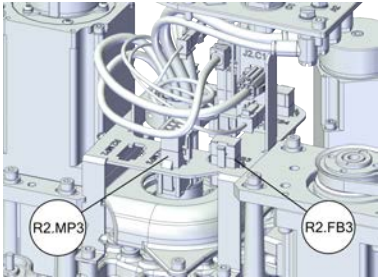
Reconnecting the connectors for axis-3 motor

	Action	Note
1	<p>For robots with protection type Clean Room: Clean the joints that have been opened and wipe the parts free from particles with spirit on a lint free. See Cut the paint or surface on the robot before replacing parts on page 118</p> <p> Note</p> <p>After all repair work, wipe the Clean Room robot free from particles with spirit on a lint free cloth.</p>	
2	<p>Insert the female head of the connectors to the bracket accordingly.</p> <p> Tip</p> <p>The mistake proofing measure has been applied to the connectors, the connectors may be damaged if excessive force is used.</p> <p> Note</p> <p>The harness are not visible due to the cleanness requirements of the illustration. They are still existing inside the cable ferrule in the actual situation.</p>	 <p>xx2100000937</p>
3	<p>Reconnect the connectors.</p> <ul style="list-style-type: none"> • R2.MP3 • R2.FB3 <p> Tip</p> <p>See the number markings on the connectors for help to find the corresponding connector.</p>	 <p>xx2100000936</p>
4	<p>Route the cabling on the axis-3 motor.</p> <p> CAUTION</p> <p>Correct cable routing is highly important. If the cables are routed and secured incorrectly the cables can be damaged.</p>	







Continues on next page

5 Repair

5.6.6 Replacing the axis-2 timing belt

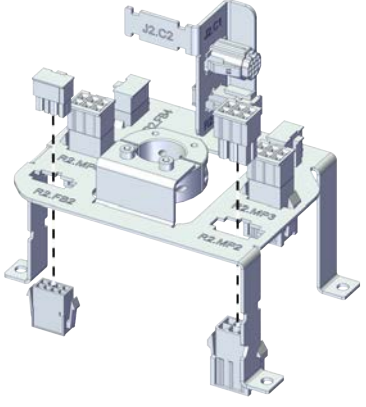

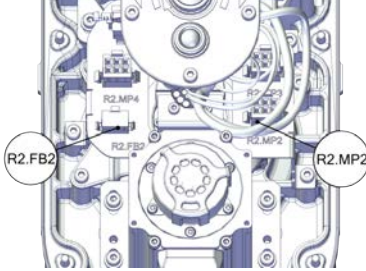
Continued

Reconnecting the connectors for axis-2 motor

	Action	Note
1	<p>For robots with protection type Clean Room: Clean the joints that have been opened and wipe the parts free from particles with spirit on a lint free. See Cut the paint or surface on the robot before replacing parts on page 118</p> <p> Note</p> <p>After all repair work, wipe the Clean Room robot free from particles with spirit on a lint free cloth.</p>	
2	<p>Insert the female head of the connectors to the bracket accordingly.</p> <p> Tip</p> <p>The mistake proofing measure has been applied to the connectors, the connectors may be damaged if excessive force is used.</p> <p> Note</p> <p>The harness are not visible due to the cleanness requirements of the illustration. They are still existing inside the cable ferrule in the actual situation.</p>	 <p>xx2100000935</p>
3	<p>Reconnect the connectors.</p> <ul style="list-style-type: none"> • R2.MP2 • R2.FB2 <p> Tip</p> <p>See the number markings on the connectors for help to find the corresponding connector.</p>	 <p>xx2100000934</p>
4	<p>Route the cabling behind the axis-2 motor.</p> <p> CAUTION</p> <p>Correct cable routing is highly important. If the cables are routed and secured incorrectly the cables can be damaged.</p>	

Continues on next page

Reconnecting the air hoses, CP/CS cabling and Ethernet cabling (if equipped)







	Action	Note
1	<p>For robots with protection type Clean Room: Clean the joints that have been opened and wipe the parts free from particles with spirit on a lint free. See Cut the paint or surface on the robot before replacing parts on page 118</p> <p> Note</p> <p>After all repair work, wipe the Clean Room robot free from particles with spirit on a lint free cloth.</p>	
2	<p>Route the air hoses on the process hub behind the bracket.</p> <p> CAUTION</p> <p>Correct cable routing is highly important. If the cables are routed and secured incorrectly the cables can be damaged.</p>	

Continues on next page

5 Repair

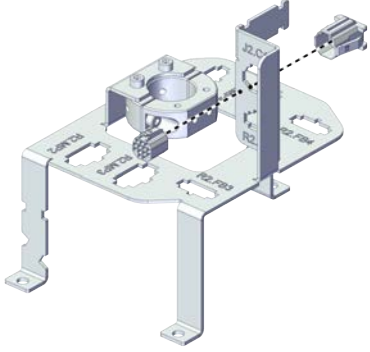
5.6.6 Replacing the axis-2 timing belt

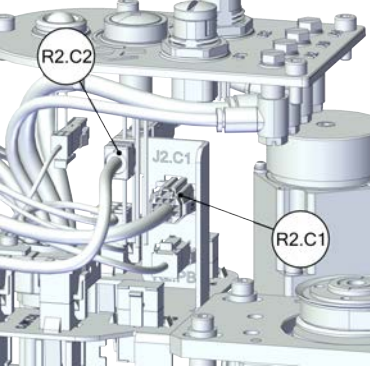

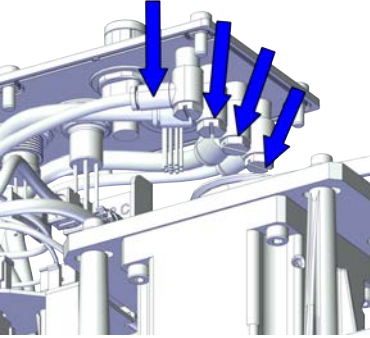
Continued

	Action	Note
3	<p>Insert the female head of the C1 cabling connector to the bracket accordingly.</p> <p> Tip</p> <p>The mistake proofing measure has been applied to the connectors, the connectors may be damaged if excessive force is used.</p> <p> Note</p> <p>The harness are not visible due to the cleanliness requirements of the illustration. They are still existing inside the cable ferrule in the actual situation.</p>	 <p>xx2100001034</p>
4	<p>For robots with C1 cabling</p> <p>Reconnect the connector.</p> <ul style="list-style-type: none"> • R2.C1 <p> Tip</p> <p>See the number markings on the air hoses for help to find the corresponding air hoses.</p> <p>The air hoses with the same number connect to the same L-shaped connector.</p>	 <p>xx2100001033</p>
5	<p>For robots with C2 cabling</p> <p>Reconnect the connector.</p> <ul style="list-style-type: none"> • R1.C2 <p> Tip</p> <p>See the number markings on the air hoses for help to find the corresponding air hoses.</p> <p>The air hoses with the same number connect to the same L-shaped connector.</p>	
6	<p>Secure the C2 cabling to the C2 bracket with the cable straps.</p>	
7	<p>Reconnect the air hoses in a cross pattern with the L-shaped connectors.</p> <p> Tip</p> <p>See the number markings on the air hoses for help to find the corresponding air hoses.</p> <p>The air hoses with the same number connect to the same Y-shaped connector.</p>	 <p>xx2100001032</p>

Continues on next page

	Action	Note
8	<p>Route and secure the cabling with cable straps if needed.</p> <p> CAUTION</p> <p>Correct cable routing is highly important. If the cables are routed and secured incorrectly the cables can be damaged.</p>	

Securing the bracket in the outer arm

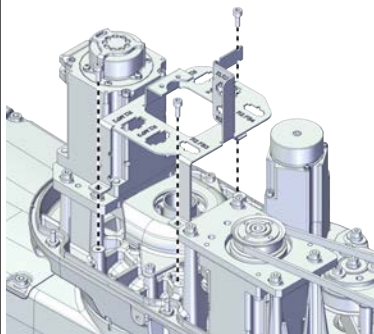
	Action	Note
1	<p>For robots with protection type Clean Room: Clean the joints that have been opened and wipe the parts free from particles with spirit on a lint free. See Cut the paint or surface on the robot before replacing parts on page 118</p> <p> Note</p> <p>After all repair work, wipe the Clean Room robot free from particles with spirit on a lint free cloth.</p>	
2	<p>Refit the bracket.</p> <p> Tip</p> <p>Do not secure it with the screws before the cable ferrule installed well.</p> <p> Note</p> <p>The harness are not visible due to the cleanness requirements of the illustration. They are still existing inside the cable ferrule in the actual situation.</p>	<p>Screws: Hex socket head cap screw M4x10 12.9 Lafre 2C2B/FC6.9 (3 pcs) Tightening torque: 1.2 Nm \pm10%</p>  <p>xx2100000941</p>

Refitting the cover of the outer arm



	Action	Note
1	<p>For robots with protection type Clean Room: Clean the joints that have been opened and wipe the parts free from particles with spirit on a lint free. See Cut the paint or surface on the robot before replacing parts on page 118</p> <p> Note</p> <p>After all repair work, wipe the Clean Room robot free from particles with spirit on a lint free cloth.</p>	

Continues on next page

5 Repair

5.6.6 Replacing the axis-2 timing belt

Continued

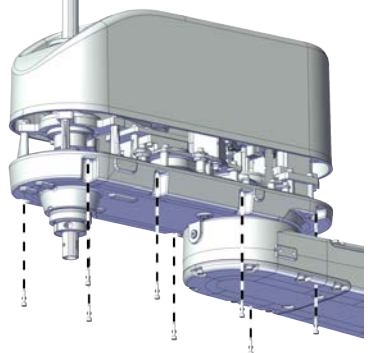
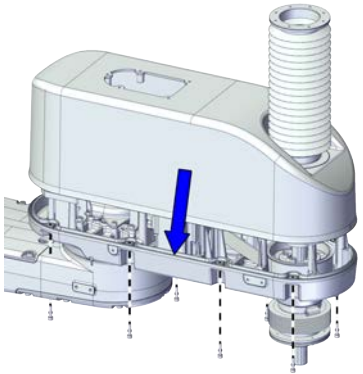

	Action	Note
2	<p>Refit the cover.</p> <p> Note</p> <p>For robots with protection class IP54 (option 3350-540)</p> <p>For robots with protection type Clean Room (option 3351-1)</p> <p>Refit the cover with bellow.</p> <p>Check the gasket for the outer arm cover.</p> <p> Tip</p> <p>Replace the gasket if needed.</p> <p> CAUTION</p> <p>The gasket is in the outer arm.</p>	<p>Screw: Hex socket head cap screw M4x16 12.9 Lafre 2C2B/FC6.9 (8 pcs)</p> <p>Tightening torque: 2 Nm ±10%</p> <p>For robots with protection class IP30 (option 3350-300)</p>  <p>xx210000933</p>
3	<p>Refit the screws.</p>	<p>For robots with protection class IP54 (option 3350-540)</p> <p>For robots with protection type Clean Room (option 3351-1)</p>  <p>xx2100002427</p>

For Clean Room/ IP54 robots

Refitting the top cover and the flange with bearing

	Action	Note
1	<p>For robots with protection type Clean Room:</p> <p>Clean the joints that have been opened and wipe the parts free from particles with spirit on a lint free. See Cut the paint or surface on the robot before replacing parts on page 118</p> <p> Note</p> <p>After all repair work, wipe the Clean Room robot free from particles with spirit on a lint free cloth.</p>	

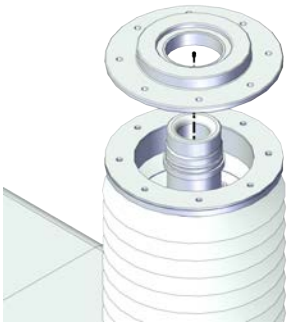
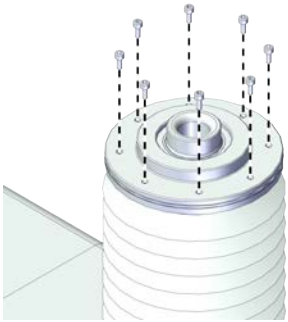
Continues on next page

	Action	Note
2	<p>For robots with protection class IP54 (option 3350-540) For robots with protection type Clean Room (option 3351-1) Install the flange with bearing to the extension shaft.</p>	 <p>xx2100002402</p>
3	<p>For robots with protection class IP54 (option 3350-540) For robots with protection type Clean Room (option 3351-1) Refit the screws to the flange with bearing.</p>	<p>Screws: Hex socket head cap screw M2.5x6 12.9 Lafre 2C2B/FC6.9 (8 pcs) Tightening torque: 0.8 Nm ±10%</p>  <p>xx2100002401</p>
4	<p>For robots with protection class IP54 (option 3350-540) For robots with protection type Clean Room (option 3351-1) Refit the top cover to the ball screw.</p> <p> Tip</p> <p>The top surface of the cover should be flush with the top end of the ball screw.</p>	 <p>xx2100002399</p>

Continues on next page

5 Repair

5.6.6 Replacing the axis-2 timing belt

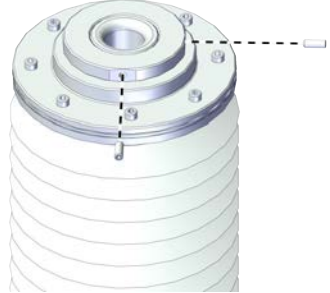

Continued

	Action	Note
5	<p>For robots with protection class IP54 (option 3350-540)</p> <p>For robots with protection type Clean Room (option 3351-1)</p> <p>Refit the locking screws.</p>	<p>Screws: Hexagon socket set screws with flat point, ISO 4026 stainless steel M3x8 (2 pcs)</p> <p>Tightening torque: 0.4 Nm \pm10%</p>  <p>xx2100002398</p>

Securing the process hub to outer arm cover

	Action	Note
1	<p>For robots with protection type Clean Room:</p> <p>Clean the joints that have been opened and wipe the parts free from particles with spirit on a lint free. See Cut the paint or surface on the robot before replacing parts on page 118</p> <p> Note</p> <p>After all repair work, wipe the Clean Room robot free from particles with spirit on a lint free cloth.</p>	
2	Insert the process hub from the outer arm cover.	

Continues on next page

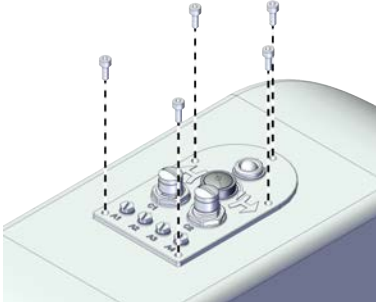
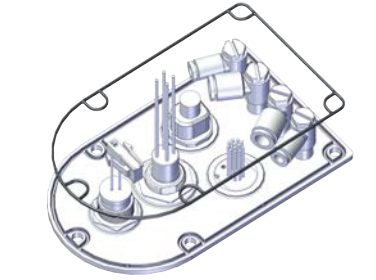
	Action	Note
3	<p>Secure the process hub to the outer arm cover with the screws.</p> <p> Note</p> <p>For robots with protection class IP54 (option 3350-540)</p> <p>For robots with protection type Clean Room (option 3351-1)</p> <p>Check the gasket for the process hub.</p> <p> Tip</p> <p>Replace the gasket if needed.</p> <p> CAUTION</p> <p>Be aware of the cabling that is attached to the cover! The cover can not be removed completely until the connectors are disconnected, as shown in following steps.</p>	<p>Screws: Hex socket head cap screw M4x10 12.9 Lafre 2C2B/FC6.9 (5 pcs)</p> <p>Tightening torque: 2.6 Nm±10%</p> <p>For robots with protection class IP30 (option 3350-300)</p>  <p>xx2100000932</p> <p>For robots with protection class IP54 (option 3350-540)</p> <p>For robots with protection type Clean Room (option 3351-1)</p>  <p>xx2100002438</p>

Concluding procedure

	Action	Note
1	<p>For robots with protection type Clean Room: Seal and paint the joints that have been opened. See Cut the paint or surface on the robot before replacing parts on page 118</p> <p> Note</p> <p>After all repair work, wipe the Clean Room robot free from particles with spirit on a lint free cloth.</p>	
2	Recalibrate the robot.	Calibration is detailed in section Calibration on page 945 .

Continues on next page

5 Repair

5.6.6 Replacing the axis-2 timing belt

Continued

	Action	Note
3	 DANGER Make sure all safety requirements are met when performing the first test run.	

5.6.7 Replacing the axis-3 timing belt

Location of the axis-3 timing belt

The axis-3 timing belt is located as shown in the figure.

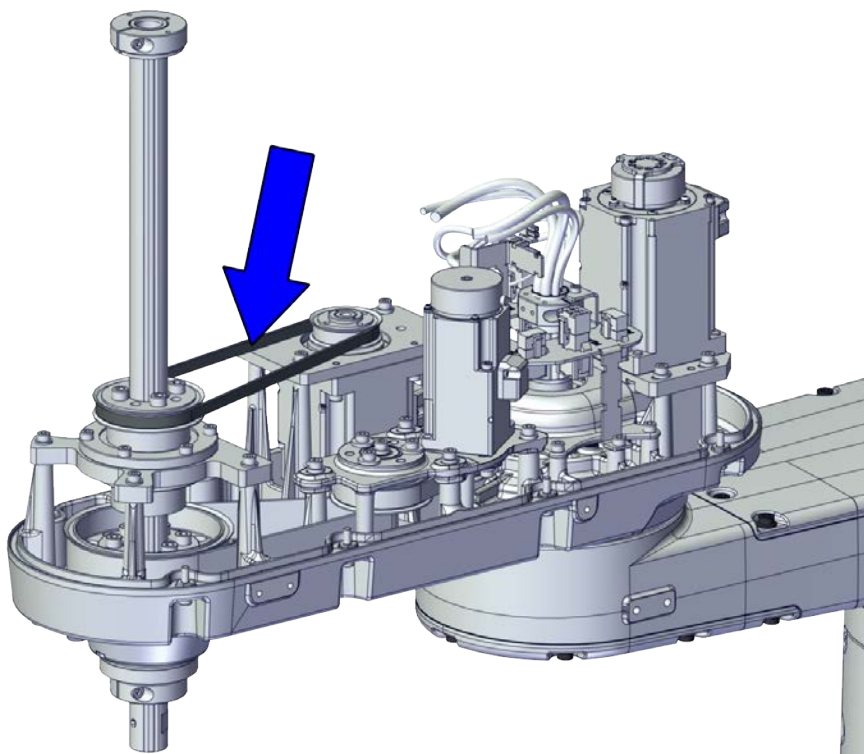

xx2100001020

Required spare parts



Note

The spare part numbers that are listed in the table can be out of date. See the latest spare parts of the IRB 920 via myABB Business Portal, www.abb.com/myABB.

Spare part	Article number	Note
Timing belt A3	3HAC070464-001	

Required tools and equipment

Equipment	Article number	Note
Standard toolkit	-	Content is defined in section Standard toolkit on page 996 .
Calibration toolbox, Axis Calibration	3HAC055412-001	Delivered as a set of calibration tools. Required if Axis Calibration is the valid calibration method for the robot.

Continues on next page

5 Repair

5.6.7 Replacing the axis-3 timing belt

Continued

Equipment	Article number	Note
24 VDC power supply	-	Used to release the motor brakes.
Sonic tension meter	-	Used for measuring the timing belt tension.

Required consumables

Consumable	Article number	Note
Cable straps	-	

Deciding calibration routine

Decide which calibration routine to be used, based on the information in the table. Depending on which routine is chosen, action might be required prior to beginning the repair work of the robot, see the table.

	Action	Note
1	Decide which calibration routine to use for calibrating the robot. <ul style="list-style-type: none">Reference calibration. External cable packages (DressPack) and tools can stay fitted on the robot.Fine calibration. All external cable packages (DressPack) and tools must be removed from the robot.	
	If the robot is to be calibrated with reference calibration: Find previous reference values for the axis or create new reference values. These values are to be used after the repair procedure is completed, for calibration of the robot. If no previous reference values exist, and no new reference values can be created, then reference calibration is not possible.	Follow the instructions given in the reference calibration routine on the FlexPendant to create reference values. Creating new values requires possibility to move the robot. Read more about reference calibration for Axis Calibration in Reference calibration routine on page 957 .
	If the robot is to be calibrated with fine calibration: Remove all external cable packages (DressPack) and tools from the robot.	



Removing the axis-3 timing belt

Use these procedures to remove the axis-3 timing belt.



Preparations before removing the axis-3 timing belt

	Action	Note
1	Decide which calibration routine to use, and take actions accordingly prior to beginning the repair procedure.	

Continues on next page

	Action	Note
2	<p>If there is no enough space for the maintenance work, remove the robot from the wall and place it on the maintenance bracket.</p> <p> CAUTION</p> <p>Do not lay down the robot during the transportation, always keep it straight. If the robot lay down in any situation, the grease may come out from gearbox.</p>	
3	<p> DANGER</p> <p>Turn off all:</p> <ul style="list-style-type: none"> • electric power supply • hydraulic pressure supply • air pressure supply <p>to the robot, before entering the safeguarded space.</p>	
4	<p> CAUTION</p> <p>For robots with protection type Clean Room Always cut the paint with a knife and grind the paint edge when disassembling parts of the robot! See Cut the paint or surface on the robot before replacing parts on page 118.</p>	

Removing the process hub screws



	Action	Note
1	<p> DANGER</p> <p>Make sure that all supplies for electrical power, hydraulic pressure, and air pressure are turned off.</p>	
2	<p> CAUTION</p> <p>For robots with protection type Clean Room Always cut the paint with a knife and grind the paint edge when disassembling parts of the robot! See Cut the paint or surface on the robot before replacing parts on page 118.</p>	

Continues on next page

5 Repair

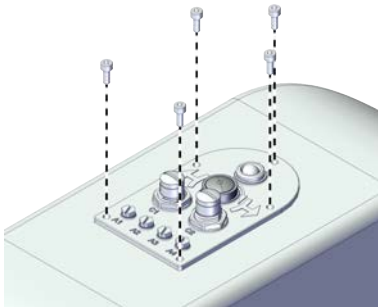
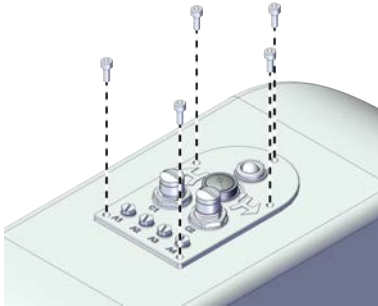

5.6.7 Replacing the axis-3 timing belt

Continued



	Action	Note
3	<p>Remove the screws on the process hub.</p> <p> Note</p> <p>For robots with protection class IP54 (option 3350-540)</p> <p>For robots with protection type Clean Room (option 3351-1)</p> <p>Remove the screws on the process hub and take out the gasket.</p> <p> Tip</p> <p>Check the gasket and replace it if needed.</p>	<p>For robots with protection class IP30</p>  <p>xx2100000932</p> <p>For robots with protection class IP54 (option 3350-540)</p> <p>For robots with protection type Clean Room (option 3351-1)</p>  <p>xx2100000932</p>
4	Insert the process hub to the outer arm.	

For Clean Room/ IP54 robots

Removing the top cover and the flange with bearing

	Action	Note
1	<p> DANGER</p> <p>Make sure that all supplies for electrical power, hydraulic pressure, and air pressure are turned off.</p>	
2	<p> CAUTION</p> <p>For robots with protection type Clean Room</p> <p>Always cut the paint with a knife and grind the paint edge when disassembling parts of the robot!</p> <p>See Cut the paint or surface on the robot before replacing parts on page 118.</p>	

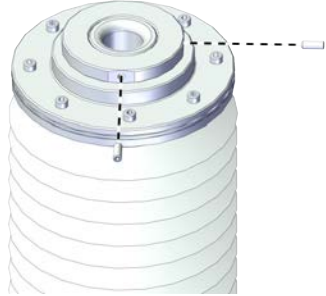
Continues on next page

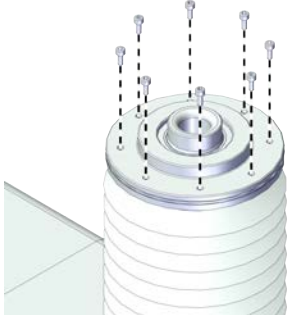
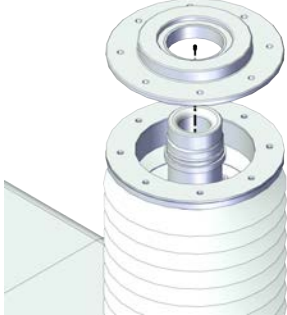
	Action	Note
3	<p>For robots with protection class IP54 (option 3350-540) For robots with protection type Clean Room (option 3351-1) Loose the locking screws.</p>	 <p>xx2100002398</p>
4	<p>For robots with protection class IP54 (option 3350-540) For robots with protection type Clean Room (option 3351-1) Remove the top cover from the ball screw.</p>	 <p>xx2100002399</p>
5	<p>For robots with protection class IP54 (option 3350-540) For robots with protection type Clean Room (option 3351-1) Remove the screws on the flange with bearing.</p>	 <p>xx2100002401</p>
6	<p>For robots with protection class IP54 (option 3350-540) For robots with protection type Clean Room (option 3351-1) Remove the flange with bearing.</p>	 <p>xx2100002402</p>





Continues on next page

5 Repair

5.6.7 Replacing the axis-3 timing belt

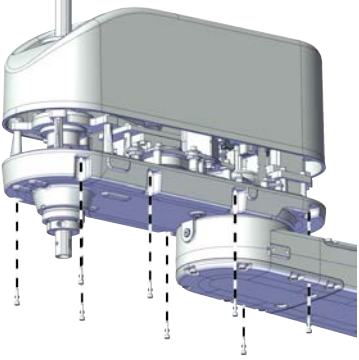
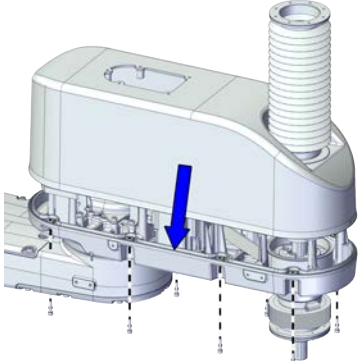

Continued

Removing the cover of the outer arm

	Action	Note
1	 DANGER Make sure that all supplies for electrical power, hydraulic pressure, and air pressure are turned off.	
2	 CAUTION For robots with protection type Clean Room Always cut the paint with a knife and grind the paint edge when disassembling parts of the robot! See Cut the paint or surface on the robot before replacing parts on page 118 .	
3	Remove the screws on the cover of the outer arm and remove the cover.  Note For robots with protection class IP54 (option 3350-540) For robots with protection type Clean Room (option 3351-1) Remove the cover with bellow and housing.  Note The bellow does not need to be removed separately.  Tip Check the gasket and replace it if needed.	For robots with protection class IP30  <small>xx210000933</small> For robots with protection class IP54 (option 3350-540) For robots with protection type Clean Room (option 3351-1)  <small>xx2100002427</small>

Continues on next page

Removing the axis-3 timing belt

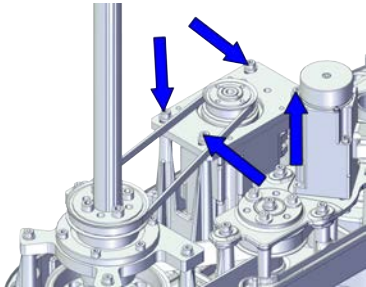
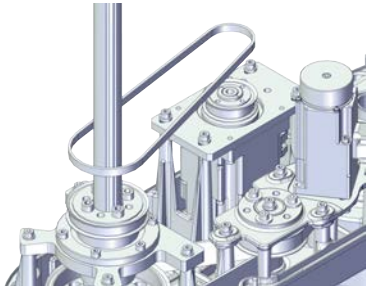
	Action	Note
1	 <p>DANGER</p> <p>Make sure that all supplies for electrical power, hydraulic pressure, and air pressure are turned off.</p>	
2	 <p>CAUTION</p> <p>For robots with protection type Clean Room Always cut the paint with a knife and grind the paint edge when disassembling parts of the robot! See <i>Cut the paint or surface on the robot before replacing parts on page 118.</i></p>	
3	 <p>DANGER</p> <p>Make sure that the ball screw is supported with something. The sudden drop of the ball screw due the lost of the axis-3 motor may cause danger.</p>	
4	<p>Loosen the screws of the axis-3 motor sub-assembly to let the axis-3 timing belt free.</p>	 <p>xx2100001078</p>
5	<p>Remove the timing belt.</p>	 <p>xx2100001079</p>

Continues on next page

5 Repair

5.6.7 Replacing the axis-3 timing belt

Continued

Refitting the axis-3 timing belt

Use these procedures to refit the axis-3 timing belt.

Refitting the axis-3 timing belt

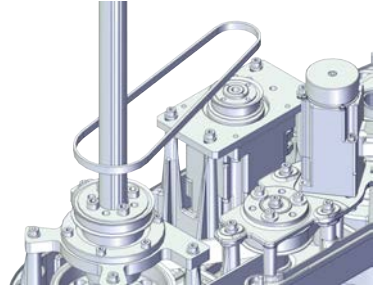
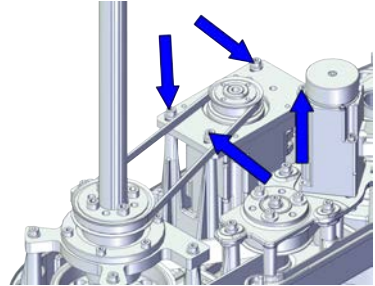
	Action	Note
1	<p>For robots with protection type Clean Room: Clean the joints that have been opened and wipe the parts free from particles with spirit on a lint free. See Cut the paint or surface on the robot before replacing parts on page 118</p> <p> Note</p> <p>After all repair work, wipe the Clean Room robot free from particles with spirit on a lint free cloth.</p>	
2	<p>Refit the timing belt to the pulley on the ball screw and the motor. Ensure that the belt runs correctly in the grooves.</p>	<p>Timing belt A3: 3HAC070464-001</p>  <p>xx2100001079</p>
3	<p>Secure the screws and washers without fully tightened.</p>	<p>Screws: Hex socket head cap screw M4x16 12.9 Lafre 2C2B/FC6.9 (4 pcs) Washers: Plain washer machining 4.2x9x2 steel (4 pcs) Tightening torque: 2.6 Nm \pm10%</p>  <p>xx2100001078</p>
4	<p>Hang a strap to the hook on the motor.</p>	

Continues on next page

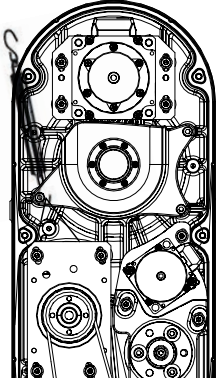
	Action	Note
5	<p>Use a handheld dynamometer hooking to the strap and pull the dynamometer to make the tension falling in the allowed force range.</p> <p> Note</p> <p>During the measurement, make sure that all interferences that may affect the force are removed. Pay attention to the force application direction.</p>	<p>Used belt: 36.6 New belt:40</p>  <p>xx2100001126</p>
6	<p>Use a sonic tension meter to measure the timing belt tension.</p>	<p>Used belt: 139 New belt:110</p>
7	<p>If the timing belt tension does not meet the requirement, loosen the motor screws and readjust.</p>	



Refitting the cover of the outer arm

	Action	Note
1	<p>For robots with protection type Clean Room: Clean the joints that have been opened and wipe the parts free from particles with spirit on a lint free. See Cut the paint or surface on the robot before replacing parts on page 118</p> <p> Note</p> <p>After all repair work, wipe the Clean Room robot free from particles with spirit on a lint free cloth.</p>	

5 Repair

5.6.7 Replacing the axis-3 timing belt

Continued

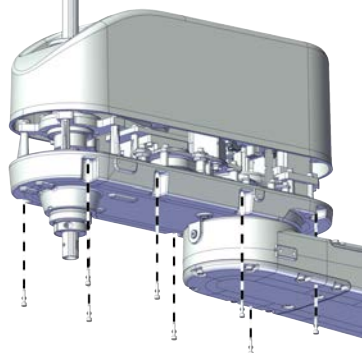
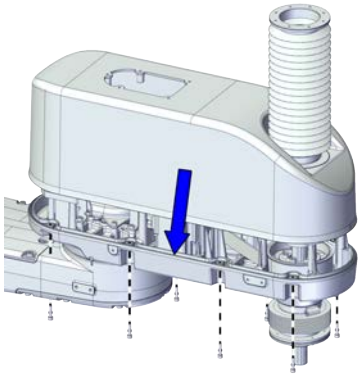

	Action	Note
2	<p>Refit the cover.</p> <p> Note</p> <p>For robots with protection class IP54 (option 3350-540)</p> <p>For robots with protection type Clean Room (option 3351-1)</p> <p>Refit the cover with bellow.</p> <p>Check the gasket for the outer arm cover.</p> <p> Tip</p> <p>Replace the gasket if needed.</p> <p> CAUTION</p> <p>The gasket is in the outer arm.</p>	<p>Screw: Hex socket head cap screw M4x16 12.9 Lafre 2C2B/FC6.9 (8 pcs)</p> <p>Tightening torque: 2 Nm ±10%</p> <p>For robots with protection class IP30 (option 3350-300)</p>  <p>xx210000933</p>
3	<p>Refit the screws.</p>	<p>For robots with protection class IP54 (option 3350-540)</p> <p>For robots with protection type Clean Room (option 3351-1)</p>  <p>xx2100002427</p>

For Clean Room/ IP54 robots

Refitting the top cover and the flange with bearing

	Action	Note
1	<p>For robots with protection type Clean Room:</p> <p>Clean the joints that have been opened and wipe the parts free from particles with spirit on a lint free. See Cut the paint or surface on the robot before replacing parts on page 118</p> <p> Note</p> <p>After all repair work, wipe the Clean Room robot free from particles with spirit on a lint free cloth.</p>	

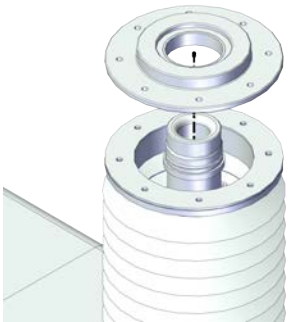
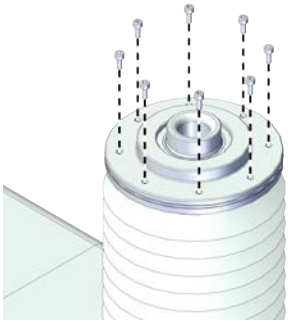
Continues on next page

	Action	Note
2	<p>For robots with protection class IP54 (option 3350-540) For robots with protection type Clean Room (option 3351-1) Install the flange with bearing to the extension shaft.</p>	 <p>xx2100002402</p>
3	<p>For robots with protection class IP54 (option 3350-540) For robots with protection type Clean Room (option 3351-1) Refit the screws to the flange with bearing.</p>	<p>Screws: Hex socket head cap screw M2.5x6 12.9 Lafre 2C2B/FC6.9 (8 pcs) Tightening torque: 0.8 Nm ±10%</p>  <p>xx2100002401</p>
4	<p>For robots with protection class IP54 (option 3350-540) For robots with protection type Clean Room (option 3351-1) Refit the top cover to the ball screw.</p> <p> Tip</p> <p>The top surface of the cover should be flush with the top end of the ball screw.</p>	 <p>xx2100002399</p>

Continues on next page

5 Repair

5.6.7 Replacing the axis-3 timing belt

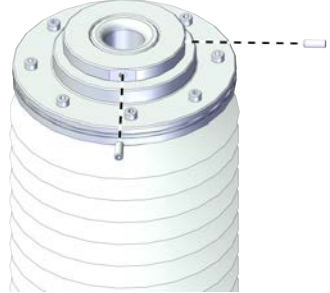

Continued

	Action	Note
5	<p>For robots with protection class IP54 (option 3350-540)</p> <p>For robots with protection type Clean Room (option 3351-1)</p> <p>Refit the locking screws.</p>	<p>Screws: Hexagon socket set screws with flat point, ISO 4026 stainless steel M3x8 (2 pcs)</p> <p>Tightening torque: 0.4 Nm \pm10%</p>  <p>xx2100002398</p>

Securing the process hub to outer arm cover

	Action	Note
1	<p>For robots with protection type Clean Room:</p> <p>Clean the joints that have been opened and wipe the parts free from particles with spirit on a lint free. See Cut the paint or surface on the robot before replacing parts on page 118</p> <p> Note</p> <p>After all repair work, wipe the Clean Room robot free from particles with spirit on a lint free cloth.</p>	
2	Insert the process hub from the outer arm cover.	

Continues on next page

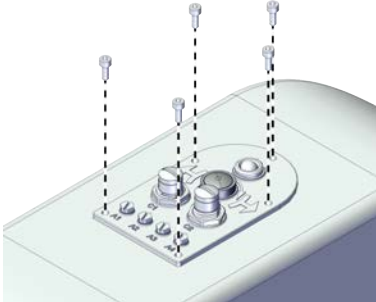
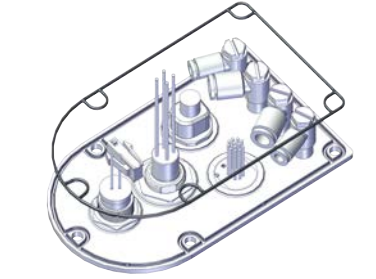
	Action	Note
3	<p>Secure the process hub to the outer arm cover with the screws.</p> <p> Note</p> <p>For robots with protection class IP54 (option 3350-540)</p> <p>For robots with protection type Clean Room (option 3351-1)</p> <p>Check the gasket for the process hub.</p> <p> Tip</p> <p>Replace the gasket if needed.</p> <p> CAUTION</p> <p>Be aware of the cabling that is attached to the cover! The cover can not be removed completely until the connectors are disconnected, as shown in following steps.</p>	<p>Screws: Hex socket head cap screw M4x10 12.9 Lafre 2C2B/FC6.9 (5 pcs)</p> <p>Tightening torque: 2.6 Nm±10%</p> <p>For robots with protection class IP30 (option 3350-300)</p>  <p>xx2100000932</p> <p>For robots with protection class IP54 (option 3350-540)</p> <p>For robots with protection type Clean Room (option 3351-1)</p>  <p>xx2100002438</p>

Concluding procedure

	Action	Note
1	<p>For robots with protection type Clean Room: Seal and paint the joints that have been opened. See Cut the paint or surface on the robot before replacing parts on page 118</p> <p> Note</p> <p>After all repair work, wipe the Clean Room robot free from particles with spirit on a lint free cloth.</p>	
2	Recalibrate the robot.	Calibration is detailed in section Calibration on page 945 .

Continues on next page

5 Repair

5.6.7 Replacing the axis-3 timing belt

Continued

	Action	Note
3	 DANGER Make sure all safety requirements are met when performing the first test run.	

5.6.8 Replacing the axis-4 second timing belt

Location of the axis-4 second timing belt

The axis-4 second timing belt is located as shown in the figure.

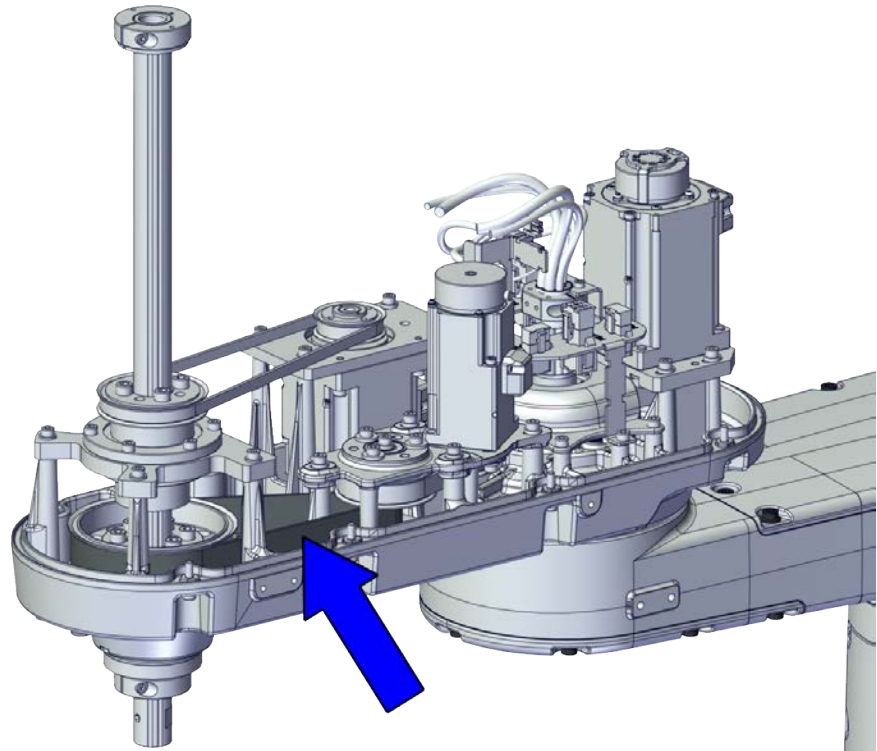

xx2100001021

Required spare parts



Note

The spare part numbers that are listed in the table can be out of date. See the latest spare parts of the IRB 920 via myABB Business Portal, www.abb.com/myABB.

Spare part	Article number	Note
Timing belt, A4-2	3HAC070471-001	

Required tools and equipment

Equipment	Article number	Note
Standard toolkit	-	Content is defined in section Standard toolkit on page 996 .
Calibration toolbox, Axis Calibration	3HAC055412-001	Delivered as a set of calibration tools. Required if Axis Calibration is the valid calibration method for the robot.

Continues on next page

5 Repair

5.6.8 Replacing the axis-4 second timing belt

Continued

Equipment	Article number	Note
24 VDC power supply	-	Used to release the motor brakes.
Sonic tension meter	-	Used for measuring the timing belt tension.
Handheld dynamometer	-	Used for measuring the timing belt tension.

Required consumables

Consumable	Article number	Note
Cable straps	-	

Deciding calibration routine

Decide which calibration routine to be used, based on the information in the table. Depending on which routine is chosen, action might be required prior to beginning the repair work of the robot, see the table.

	Action	Note
1	Decide which calibration routine to use for calibrating the robot. <ul style="list-style-type: none">Reference calibration. External cable packages (DressPack) and tools can stay fitted on the robot.Fine calibration. All external cable packages (DressPack) and tools must be removed from the robot.	
	If the robot is to be calibrated with reference calibration: Find previous reference values for the axis or create new reference values. These values are to be used after the repair procedure is completed, for calibration of the robot. If no previous reference values exist, and no new reference values can be created, then reference calibration is not possible.	Follow the instructions given in the reference calibration routine on the FlexPendant to create reference values. Creating new values requires possibility to move the robot. Read more about reference calibration for Axis Calibration in Reference calibration routine on page 957 .
	If the robot is to be calibrated with fine calibration: Remove all external cable packages (DressPack) and tools from the robot.	



Removing the axis-4 second timing belt

Use these procedures to remove the axis-4 second timing belt.

Preparations before removing the axis-4 second timing belt

	Action	Note
1	Decide which calibration routine to use, and take actions accordingly prior to beginning the repair procedure.	

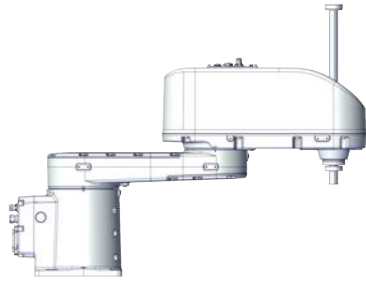
Continues on next page

	Action	Note
2	<p>If there is not enough space for the maintenance work, remove the robot from the wall and place it on the maintenance bracket.</p> <p> CAUTION</p> <p>Do not lay down the robot during the transportation, always keep it straight. If the robot lay down in any situation, the grease may come out from gearbox.</p>	
3	<p>Jog all axes to zero position.</p>	 <p>xx210000930</p>
4	<p> DANGER</p> <p>Turn off all:</p> <ul style="list-style-type: none"> • electric power supply • hydraulic pressure supply • air pressure supply <p>to the robot, before entering the safeguarded space.</p>	
5	<p> CAUTION</p> <p>For robots with protection type Clean Room Always cut the paint with a knife and grind the paint edge when disassembling parts of the robot! See Cut the paint or surface on the robot before replacing parts on page 118.</p>	

Removing the process hub screws



	Action	Note
1	<p> DANGER</p> <p>Make sure that all supplies for electrical power, hydraulic pressure, and air pressure are turned off.</p>	

Continues on next page

5 Repair

5.6.8 Replacing the axis-4 second timing belt

Continued

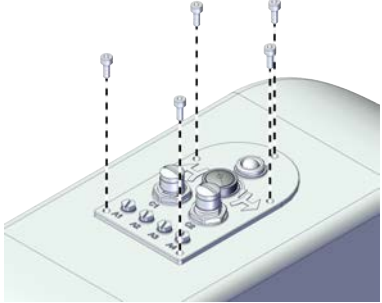
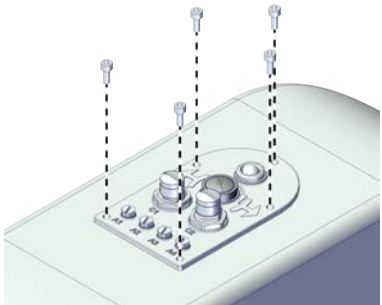

	Action	Note
2	 CAUTION For robots with protection type Clean Room Always cut the paint with a knife and grind the paint edge when disassembling parts of the robot! See Cut the paint or surface on the robot before replacing parts on page 118 .	
3	Remove the screws on the process hub.  Note For robots with protection class IP54 (option 3350-540) For robots with protection type Clean Room (option 3351-1) Remove the screws on the process hub and take out the gasket.  Tip Check the gasket and replace it if needed.	For robots with protection class IP30  <small>xx2100000932</small> For robots with protection class IP54 (option 3350-540) For robots with protection type Clean Room (option 3351-1)  <small>xx2100000932</small>
4	Insert the process hub to the outer arm.	

For Clean Room/ IP54 robots

Removing the top cover and the flange with bearing

	Action	Note
1	 DANGER Make sure that all supplies for electrical power, hydraulic pressure, and air pressure are turned off.	

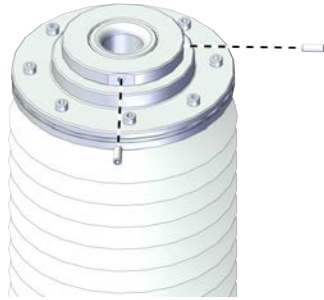
Continues on next page

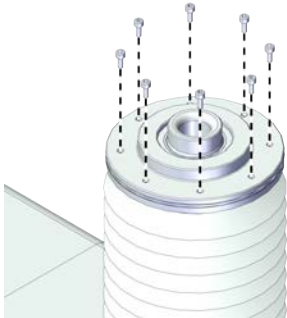
	Action	Note
2	<p> CAUTION</p> <p>For robots with protection type Clean Room Always cut the paint with a knife and grind the paint edge when disassembling parts of the robot! See <i>Cut the paint or surface on the robot before replacing parts on page 118.</i></p>	
3	<p>For robots with protection class IP54 (option 3350-540) For robots with protection type Clean Room (option 3351-1) Loose the locking screws.</p>	 <p>xx2100002398</p>
4	<p>For robots with protection class IP54 (option 3350-540) For robots with protection type Clean Room (option 3351-1) Remove the top cover from the ball screw.</p>	 <p>xx2100002399</p>
5	<p>For robots with protection class IP54 (option 3350-540) For robots with protection type Clean Room (option 3351-1) Remove the screws on the flange with bearing.</p>	 <p>xx2100002401</p>

Continues on next page



5 Repair

5.6.8 Replacing the axis-4 second timing belt

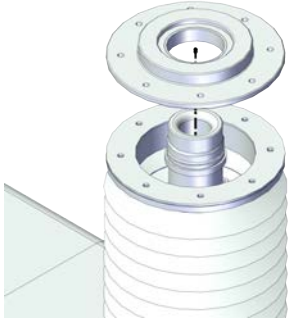

Continued

	Action	Note
6	<p>For robots with protection class IP54 (option 3350-540)</p> <p>For robots with protection type Clean Room (option 3351-1)</p> <p>Remove the flange with bearing.</p>	 <p>xx2100002402</p>

Removing the cover of the outer arm

	Action	Note
1	 <p>DANGER</p> <p>Make sure that all supplies for electrical power, hydraulic pressure, and air pressure are turned off.</p>	
2	 <p>CAUTION</p> <p>For robots with protection type Clean Room</p> <p>Always cut the paint with a knife and grind the paint edge when disassembling parts of the robot!</p> <p>See Cut the paint or surface on the robot before replacing parts on page 118.</p>	

Continues on next page

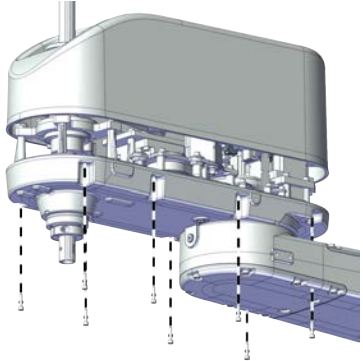
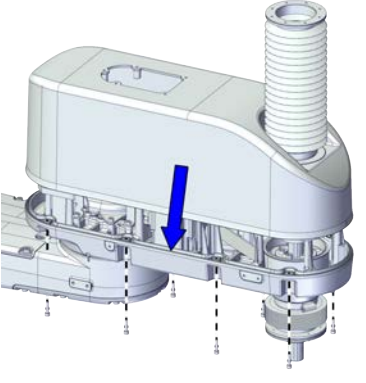
	Action	Note
3	<p>Remove the screws on the cover of the outer arm and remove the cover.</p> <p> Note</p> <p>For robots with protection class IP54 (option 3350-540) For robots with protection type Clean Room (option 3351-1) Remove the cover with bellow and housing.</p> <p> Note</p> <p>The bellow does not need to be removed separately.</p> <p> Tip</p> <p>Check the gasket and replace it if needed.</p>	<p>For robots with protection class IP30</p>  <p>xx2100000933</p> <p>For robots with protection class IP54 (option 3350-540) For robots with protection type Clean Room (option 3351-1)</p>  <p>xx2100002427</p>



Disconnecting the connectors for axis-4 motor

	Action	Note
1	<p>For robots with protection type Clean Room: Clean the joints that have been opened and wipe the parts free from particles with spirit on a lint free. See Cut the paint or surface on the robot before replacing parts on page 118</p> <p> Note</p> <p>After all repair work, wipe the Clean Room robot free from particles with spirit on a lint free cloth.</p>	

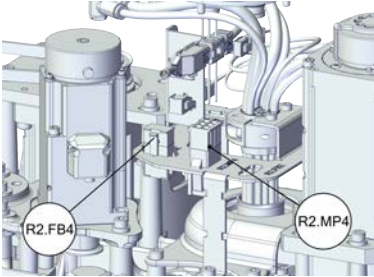

5 Repair

5.6.8 Replacing the axis-4 second timing belt

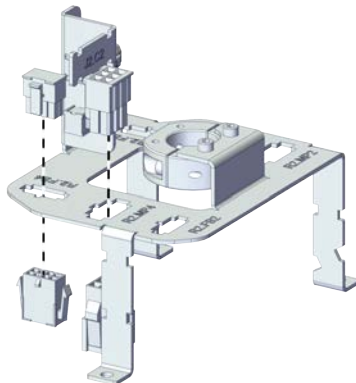
Continued

	Action	Note
2	Disconnect the axis-4 motor connectors. <ul style="list-style-type: none"> • R2.MP4 • R2.FB4 	 <p>xx2100000938</p>
3	Snap loose and remove the female head of the connectors from the bracket.  Note The harness are not visible due to the cleanness requirements of the illustration. They are still existing inside the cable ferrule in the actual situation.	 <p>xx2100000939</p>

Removing the axis-3 timing belt

	Action	Note
1	 DANGER Make sure that all supplies for electrical power, hydraulic pressure, and air pressure are turned off.	
2	 CAUTION For robots with protection type Clean Room Always cut the paint with a knife and grind the paint edge when disassembling parts of the robot! See Cut the paint or surface on the robot before replacing parts on page 118 .	
3	 DANGER Make sure that the ball screw is supported with something. The sudden drop of the ball screw due the lost of the axis-3 motor may cause danger.	



Continues on next page

5.6.8 Replacing the axis-4 second timing belt

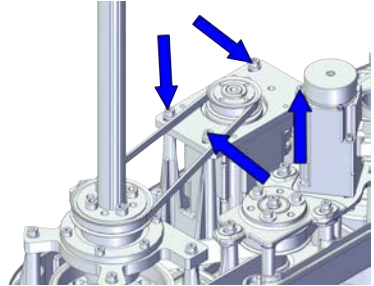
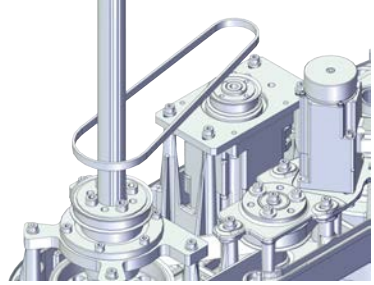
Continued

	Action	Note
4	Loosen the screws of the axis-3 motor sub-assembly to let the axis-3 timing belt free.	 <p>xx2100001078</p>
5	Remove the timing belt.	 <p>xx2100001079</p>

Releasing the ball screw flange

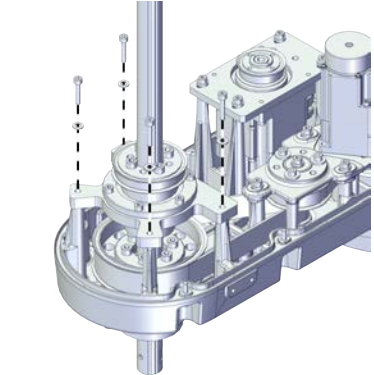
	Action	Note
1	 <p>DANGER</p> <p>Make sure that all supplies for electrical power, hydraulic pressure, and air pressure are turned off.</p>	
2	 <p>CAUTION</p> <p>For robots with protection type Clean Room Always cut the paint with a knife and grind the paint edge when disassembling parts of the robot! See Cut the paint or surface on the robot before replacing parts on page 118.</p>	
3	Removing the screws of the ball screw flange to make enough space for removing the axis-4 second timing belt.	 <p>xx2100001082</p>



Continues on next page

5 Repair



5.6.8 Replacing the axis-4 second timing belt

Continued

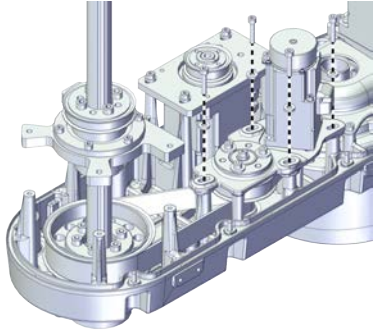
Removing the transmission module assembly

	Action	Note
1	 DANGER Make sure that all supplies for electrical power, hydraulic pressure, and air pressure are turned off.	
2	 CAUTION For robots with protection type Clean Room Always cut the paint with a knife and grind the paint edge when disassembling parts of the robot! See Cut the paint or surface on the robot before replacing parts on page 118 .	
3	Removing the screws of the transmission module assembly.	 xx2100001091
4	Take out the transmission module assembly with the axis-4-2 timing belt.	

Removing the axis-4 second timing belt

	Action	Note
1	 DANGER Make sure that all supplies for electrical power, hydraulic pressure, and air pressure are turned off.	
2	 CAUTION For robots with protection type Clean Room Always cut the paint with a knife and grind the paint edge when disassembling parts of the robot! See Cut the paint or surface on the robot before replacing parts on page 118 .	

Continues on next page

5.6.8 Replacing the axis-4 second timing belt

Continued

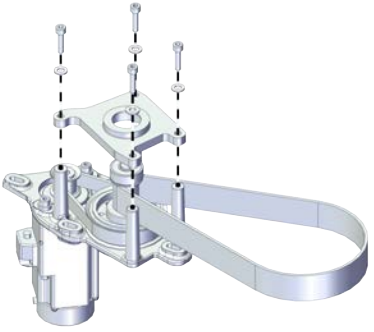
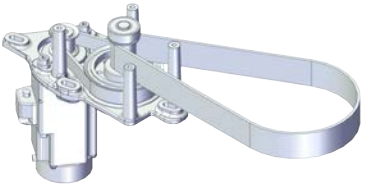
	Action	Note
3	Remove the screws and washers on the transmission module flange to let the axis-4 second timing belt be free.	 <p>xx2100001092</p>
4	Remove the timing belt.	 <p>xx2100001093</p>

Refitting the axis-4 second timing belt

Use these procedures to refit the axis-4 second timing belt.

Refitting the axis-4 second timing belt to the transmission module

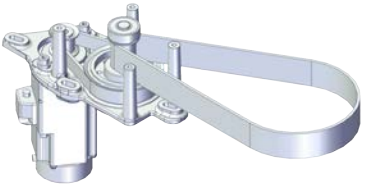
	Action	Note
1	<p>For robots with protection type Clean Room: Clean the joints that have been opened and wipe the parts free from particles with spirit on a lint free. See Cut the paint or surface on the robot before replacing parts on page 118</p> <p> Note</p> <p>After all repair work, wipe the Clean Room robot free from particles with spirit on a lint free cloth.</p>	
2	Refit the timing belt to the transmission module.	 <p>xx2100001093</p> <p>Timing belt, A4-2: 3HAC070471-001</p>

Continues on next page



5 Repair

5.6.8 Replacing the axis-4 second timing belt

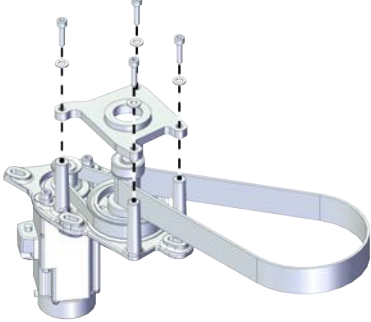
Continued

	Action	Note
3	Refit the transmission module flange and secure with the screws and washers.	Screws: Hex socket head cap screw M4x16 12.9 Lafre 2C2B/FC6.9 (4 pcs) Washers: Spring washer 9x4.3x1 Steel (4 pcs) Tightening torque: 3.5 Nm \pm 10%  xx2100001092

Refitting the transmission module assembly to the outer arm

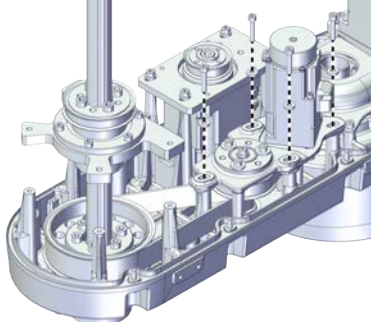

	Action	Note
1	For robots with protection type Clean Room: Clean the joints that have been opened and wipe the parts free from particles with spirit on a lint free. See Cut the paint or surface on the robot before replacing parts on page 118  Note After all repair work, wipe the Clean Room robot free from particles with spirit on a lint free cloth.	
2	Refit the transmission module assembly to the outer arm.  Tip Place the axis-4 second timing belt through the ball screw flange.	Screws: Hex socket head cap screw M4x20 12.9 Lafre 2C2B/FC6.9 (4 pcs) Washers: Plain washer machining 4.2x9x2 steel (4 pcs) Tightening torque: 2.6 Nm \pm 10%
3	Secure with the screws without fully tightened.	 xx2100001091

Continues on next page

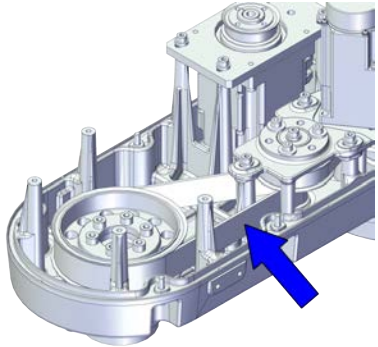
Refitting the axis-4 second timing belt to the pulley

	Action	Note
1	<p>For robots with protection type Clean Room: Clean the joints that have been opened and wipe the parts free from particles with spirit on a lint free. See Cut the paint or surface on the robot before replacing parts on page 118</p> <p> Note</p> <p>After all repair work, wipe the Clean Room robot free from particles with spirit on a lint free cloth.</p>	
2	<p>Refit the belt to the pulley. Ensure that the belt runs correctly in the grooves.</p>	<p>Timing belt, A4-2: 3HAC070471-001</p>  <p>xx2100001086</p>

Fastening the ball screw flange

	Action	Note
1	<p> DANGER</p> <p>Make sure that all supplies for electrical power, hydraulic pressure, and air pressure are turned off.</p>	
2	<p> CAUTION</p> <p>For robots with protection type Clean Room Always cut the paint with a knife and grind the paint edge when disassembling parts of the robot! See Cut the paint or surface on the robot before replacing parts on page 118.</p>	
3	<p> DANGER</p> <p>Make sure that the ball screw is supported with something. The sudden drop of the ball screw due the lost of the axis-3 motor may cause danger.</p>	

Continues on next page



5 Repair

5.6.8 Replacing the axis-4 second timing belt

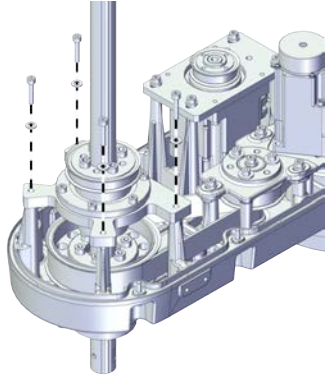
Continued

	Action	Note
4	Tighten the screws of the ball screw flange.	 xx2100001082

Adjusting the axis-4 second timing belt tension

	Action	Note
1	 DANGER Make sure that all supplies for electrical power, hydraulic pressure, and air pressure are turned off.	
2	 CAUTION For robots with protection type Clean Room Always cut the paint with a knife and grind the paint edge when disassembling parts of the robot! See Cut the paint or surface on the robot before replacing parts on page 118 .	
3	 DANGER Make sure that the ball screw is supported with something. The sudden drop of the ball screw due the lost of the axis-3 motor may cause danger.	
4	Hang a strong strap to the motor.	

Continues on next page

5.6.8 Replacing the axis-4 second timing belt

Continued

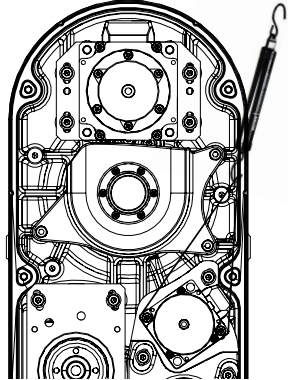
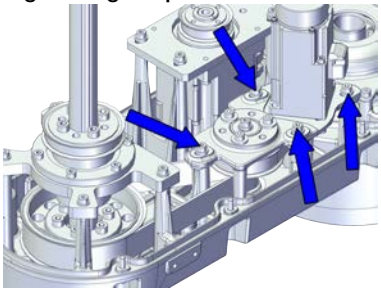
	Action	Note
5	<p>Use a handheld dynamometer hooking to the strap and pull the dynamometer to make the tension falling in the allowed force range.</p> <p> Note</p> <p>During the measurement, make sure that all interferences that may affect the force are removed. Pay attention to the force application direction.</p>	<p>Used belt: 100 New belt:240</p>  <p>xx2100001127</p>
6	<p>Fasten the screws on the transmission module to the recommended tightening torque.</p>	<p>Tightening torque: 2.6 Nm ±10%</p>  <p>xx2100001087</p>
7	<p>Use a sonic tension meter to measure the timing belt tension.</p>	<p>Used belt: 202 New belt:180</p>
8	<p>If the timing belt tension does not meet the requirement, loosen the motor screws and readjust.</p>	

Reconnecting the connectors for axis-4 motor







	Action	Note
1	<p>For robots with protection type Clean Room: Clean the joints that have been opened and wipe the parts free from particles with spirit on a lint free. See Cut the paint or surface on the robot before replacing parts on page 118</p> <p> Note</p> <p>After all repair work, wipe the Clean Room robot free from particles with spirit on a lint free cloth.</p>	

Continues on next page

5 Repair

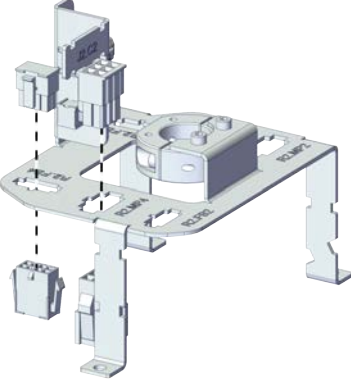
5.6.8 Replacing the axis-4 second timing belt

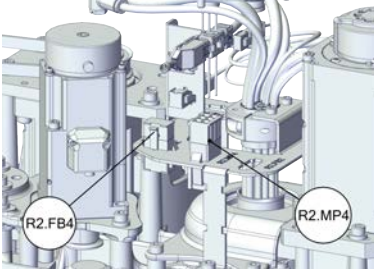
Continued

	Action	Note
	<p>Insert the female head of the connectors to the bracket accordingly.</p> <p> Tip</p> <p>The mistake proofing measure has been applied to the connectors, the connectors may be damaged if excessive force is used.</p> <p> Note</p> <p>The harness are not visible due to the cleanliness requirements of the illustration. They are still existing inside the cable ferrule in the actual situation.</p>	 <p>xx2100000939</p>
2	<p>Reconnect the connectors.</p> <ul style="list-style-type: none"> • R2.MP4 • R2.FB4 <p> Tip</p> <p>See the number markings on the connectors for help to find the corresponding connector.</p>	 <p>xx2100000938</p>
3	<p>Route the cabling on the axis-4 motor.</p> <p> CAUTION</p> <p>Correct cable routing is highly important. If the cables are routed and secured incorrectly the cables can be damaged.</p>	



Refitting the axis-3 timing belt

	Action	Note
1	<p>For robots with protection type Clean Room: Clean the joints that have been opened and wipe the parts free from particles with spirit on a lint free. See Cut the paint or surface on the robot before replacing parts on page 118</p> <p> Note</p> <p>After all repair work, wipe the Clean Room robot free from particles with spirit on a lint free cloth.</p>	

Continues on next page

5.6.8 Replacing the axis-4 second timing belt

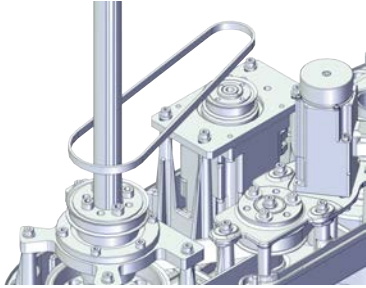
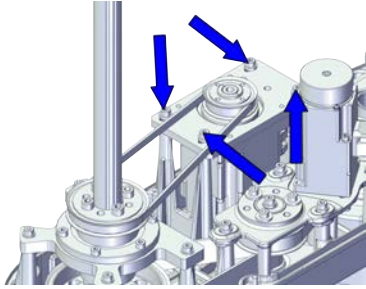
Continued

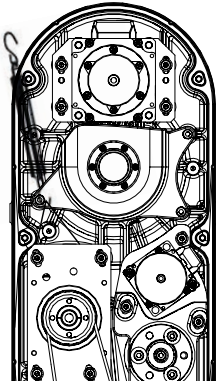
	Action	Note
2	Refit the timing belt to the pulley on the ball screw and the motor. Ensure that the belt runs correctly in the grooves.	<p>Timing belt A3: 3HAC070464-001</p>  <p>xx2100001079</p>
3	Secure the screws and washers without fully tightened.	<p>Screws: Hex socket head cap screw M4x16 12.9 Lafre 2C2B/FC6.9 (4 pcs) Washers: Plain washer machining 4.2x9x2 steel (4 pcs) Tightening torque: 2.6 Nm ±10%</p>  <p>xx2100001078</p>
4	Hang a strap to the hook on the motor.	
5	<p>Use a handheld dynamometer hooking to the strap and pull the dynamometer to make the tension falling in the allowed force range.</p> <p> Note</p> <p>During the measurement, make sure that all interferences that may affect the force are removed. Pay attention to the force application direction.</p>	<p>Used belt: 36.6 New belt:40</p>  <p>xx2100001126</p>
6	Use a sonic tension meter to measure the timing belt tension.	<p>Used belt: 139 New belt:110</p>
7	If the timing belt tension does not meet the requirement, loosen the motor screws and readjust.	





Continues on next page

5 Repair

5.6.8 Replacing the axis-4 second timing belt

Continued

Refitting the cover of the outer arm

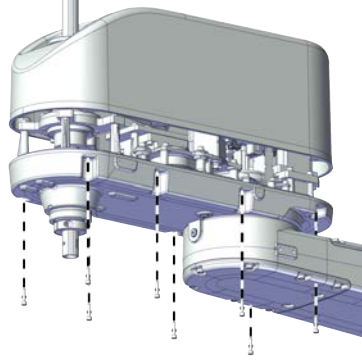
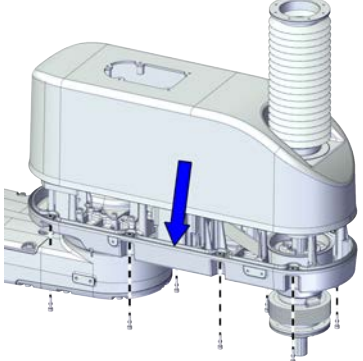
	Action	Note
1	<p>For robots with protection type Clean Room: Clean the joints that have been opened and wipe the parts free from particles with spirit on a lint free. See Cut the paint or surface on the robot before replacing parts on page 118</p> <p> Note</p> <p>After all repair work, wipe the Clean Room robot free from particles with spirit on a lint free cloth.</p>	
2	<p>Refit the cover.</p> <p> Note</p> <p>For robots with protection class IP54 (option 3350-540)</p> <p>For robots with protection type Clean Room (option 3351-1)</p> <p>Refit the cover with bellow.</p> <p>Check the gasket for the outer arm cover.</p> <p> Tip</p> <p>Replace the gasket if needed.</p> <p> CAUTION</p> <p>The gasket is in the outer arm.</p>	<p>Screw: Hex socket head cap screw M4x16 12.9 Lafre 2C2B/FC6.9 (8 pcs)</p> <p>Tightening torque: 2 Nm ±10%</p> <p>For robots with protection class IP30 (option 3350-300)</p>  <p>xx210000933</p>
3	<p>Refit the screws.</p>	<p>For robots with protection class IP54 (option 3350-540)</p> <p>For robots with protection type Clean Room (option 3351-1)</p>  <p>xx2100002427</p>

Continues on next page

For Clean Room/ IP54 robots

Refitting the top cover and the flange with bearing

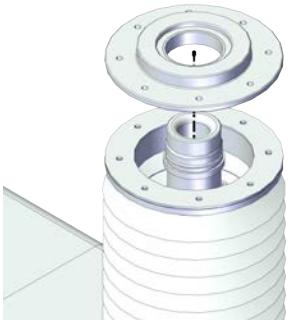
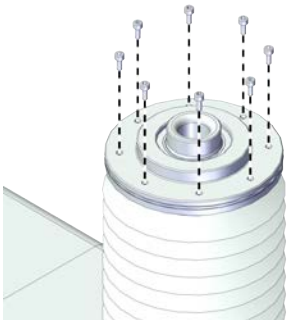

	Action	Note
1	<p>For robots with protection type Clean Room: Clean the joints that have been opened and wipe the parts free from particles with spirit on a lint free. See Cut the paint or surface on the robot before replacing parts on page 118</p> <p> Note</p> <p>After all repair work, wipe the Clean Room robot free from particles with spirit on a lint free cloth.</p>	
2	<p>For robots with protection class IP54 (option 3350-540) For robots with protection type Clean Room (option 3351-1) Install the flange with bearing to the extension shaft.</p>	 <p>xx2100002402</p>
3	<p>For robots with protection class IP54 (option 3350-540) For robots with protection type Clean Room (option 3351-1) Refit the screws to the flange with bearing.</p>	<p>Screws: Hex socket head cap screw M2.5x6 12.9 Lafre 2C2B/FC6.9 (8 pcs) Tightening torque: 0.8 Nm ±10%</p>  <p>xx2100002401</p>

Continues on next page

5 Repair

5.6.8 Replacing the axis-4 second timing belt

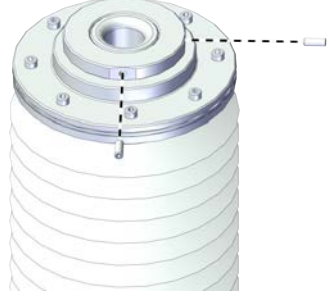

Continued

	Action	Note
4	<p>For robots with protection class IP54 (option 3350-540) For robots with protection type Clean Room (option 3351-1) Refit the top cover to the ball screw.</p> <p> Tip</p> <p>The top surface of the cover should be flush with the top end of the ball screw.</p>	 <p>xx2100002399</p>
5	<p>For robots with protection class IP54 (option 3350-540) For robots with protection type Clean Room (option 3351-1) Refit the locking screws.</p>	<p>Screws: Hexagon socket set screws with flat point, ISO 4026 stainless steel M3x8 (2 pcs) Tightening torque: 0.4 Nm \pm10%</p>  <p>xx2100002398</p>

Securing the process hub to outer arm cover

	Action	Note
1	<p>For robots with protection type Clean Room: Clean the joints that have been opened and wipe the parts free from particles with spirit on a lint free. See Cut the paint or surface on the robot before replacing parts on page 118</p> <p> Note</p> <p>After all repair work, wipe the Clean Room robot free from particles with spirit on a lint free cloth.</p>	
2	Insert the process hub from the outer arm cover.	

Continues on next page

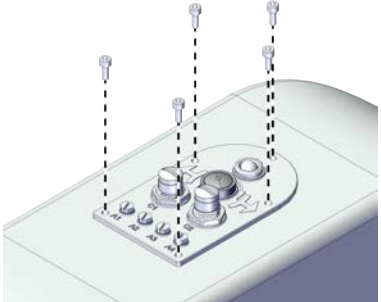
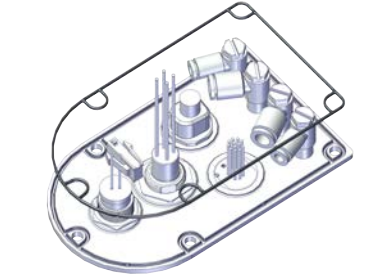
	Action	Note
3	<p>Secure the process hub to the outer arm cover with the screws.</p> <p> Note</p> <p>For robots with protection class IP54 (option 3350-540)</p> <p>For robots with protection type Clean Room (option 3351-1)</p> <p>Check the gasket for the process hub.</p> <p> Tip</p> <p>Replace the gasket if needed.</p> <p> CAUTION</p> <p>Be aware of the cabling that is attached to the cover! The cover can not be removed completely until the connectors are disconnected, as shown in following steps.</p>	<p>Screws: Hex socket head cap screw M4x10 12.9 Lafre 2C2B/FC6.9 (5 pcs)</p> <p>Tightening torque: 2.6 Nm±10%</p> <p>For robots with protection class IP30 (option 3350-300)</p>  <p>xx2100000932</p> <p>For robots with protection class IP54 (option 3350-540)</p> <p>For robots with protection type Clean Room (option 3351-1)</p>  <p>xx2100002438</p>

Concluding procedure

	Action	Note
1	<p>For robots with protection type Clean Room: Seal and paint the joints that have been opened. See Cut the paint or surface on the robot before replacing parts on page 118</p> <p> Note</p> <p>After all repair work, wipe the Clean Room robot free from particles with spirit on a lint free cloth.</p>	
2	Recalibrate the robot.	Calibration is detailed in section Calibration on page 945 .

Continues on next page

5 Repair

5.6.8 Replacing the axis-4 second timing belt

Continued

	Action	Note
3	 DANGER Make sure all safety requirements are met when performing the first test run.	

5.6.9 Replacing the axis-4 timing belt

Location of the axis-4 timing belt

The axis-4 timing belt is located as shown in the figure.

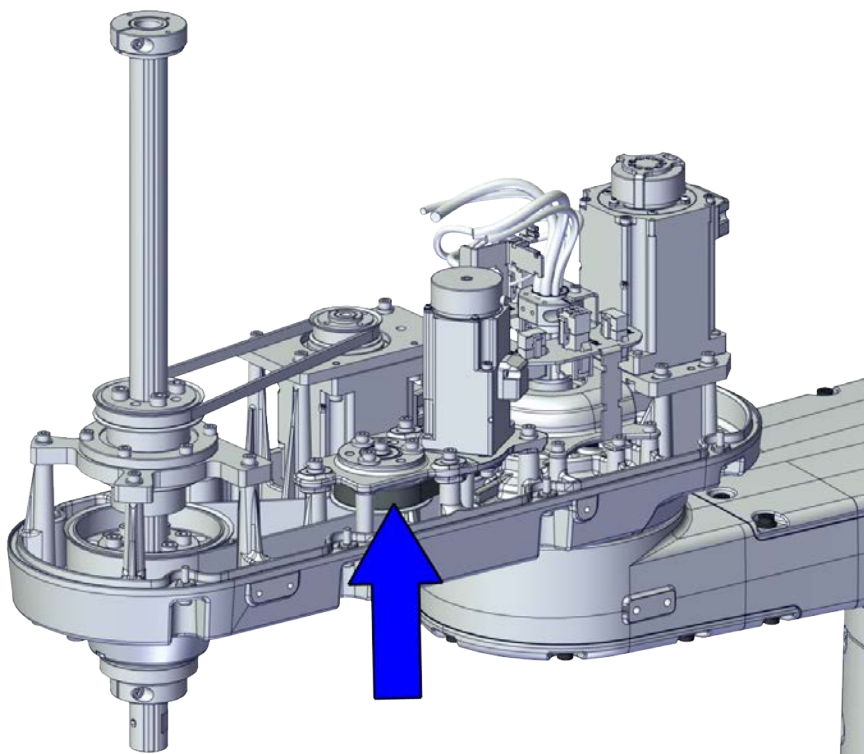

xx2100001022

Required spare parts



Note

The spare part numbers that are listed in the table can be out of date. See the latest spare parts of the IRB 920 via myABB Business Portal, www.abb.com/myABB.

Spare part	Article number	Note
Timing belt, A4-1	3HAC070470-001	

Required tools and equipment

Equipment	Article number	Note
Standard toolkit	-	Content is defined in section Standard toolkit on page 996 .
Calibration toolbox, Axis Calibration	3HAC055412-001	Delivered as a set of calibration tools. Required if Axis Calibration is the valid calibration method for the robot.

Continues on next page

5 Repair

5.6.9 Replacing the axis-4 timing belt

Continued

Equipment	Article number	Note
24 VDC power supply	-	Used to release the motor brakes.
Sonic tension meter	-	Used for measuring the timing belt tension.

Required consumables

Consumable	Article number	Note
Cable straps	-	

Deciding calibration routine

Decide which calibration routine to be used, based on the information in the table. Depending on which routine is chosen, action might be required prior to beginning the repair work of the robot, see the table.

	Action	Note
1	Decide which calibration routine to use for calibrating the robot. <ul style="list-style-type: none">Reference calibration. External cable packages (DressPack) and tools can stay fitted on the robot.Fine calibration. All external cable packages (DressPack) and tools must be removed from the robot.	
	If the robot is to be calibrated with reference calibration: Find previous reference values for the axis or create new reference values. These values are to be used after the repair procedure is completed, for calibration of the robot. If no previous reference values exist, and no new reference values can be created, then reference calibration is not possible.	Follow the instructions given in the reference calibration routine on the FlexPendant to create reference values. Creating new values requires possibility to move the robot. Read more about reference calibration for Axis Calibration in Reference calibration routine on page 957 .
	If the robot is to be calibrated with fine calibration: Remove all external cable packages (DressPack) and tools from the robot.	



Removing the axis-4 timing belt

Use these procedures to remove the axis-4 timing belt.

Preparations before removing the axis-4 timing belt

	Action	Note
1	Decide which calibration routine to use, and take actions accordingly prior to beginning the repair procedure.	

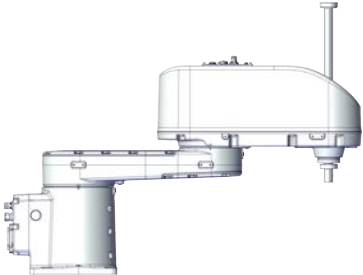
Continues on next page

	Action	Note
2	<p>If there is no enough space for the maintenance work, remove the robot from the wall and place it on the maintenance bracket.</p> <p> CAUTION</p> <p>Do not lay down the robot during the transportation, always keep it straight. If the robot lay down in any situation, the grease may come out from gearbox.</p>	
3	<p>Jog all axes to zero position.</p>	 <p>xx2100000930</p>
4	<p> DANGER</p> <p>Turn off all:</p> <ul style="list-style-type: none"> • electric power supply • hydraulic pressure supply • air pressure supply <p>to the robot, before entering the safeguarded space.</p>	
5	<p> CAUTION</p> <p>For robots with protection type Clean Room Always cut the paint with a knife and grind the paint edge when disassembling parts of the robot! See Cut the paint or surface on the robot before replacing parts on page 118.</p>	



Removing the process hub screws

	Action	Note
1	<p> DANGER</p> <p>Make sure that all supplies for electrical power, hydraulic pressure, and air pressure are turned off.</p>	

5 Repair

5.6.9 Replacing the axis-4 timing belt

Continued

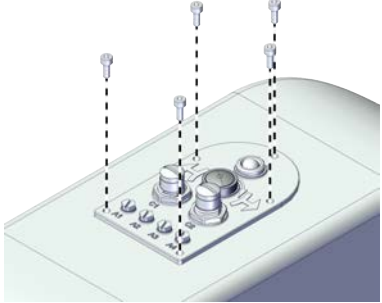
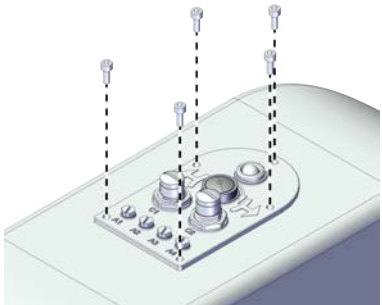

	Action	Note
2	 CAUTION For robots with protection type Clean Room Always cut the paint with a knife and grind the paint edge when disassembling parts of the robot! See Cut the paint or surface on the robot before replacing parts on page 118 .	
3	Remove the screws on the process hub.  Note For robots with protection class IP54 (option 3350-540) For robots with protection type Clean Room (option 3351-1) Remove the screws on the process hub and take out the gasket.  Tip Check the gasket and replace it if needed.	For robots with protection class IP30  <small>xx2100000932</small> For robots with protection class IP54 (option 3350-540) For robots with protection type Clean Room (option 3351-1)  <small>xx2100000932</small>
4	Insert the process hub to the outer arm.	

For Clean Room/ IP54 robots

Removing the top cover and the flange with bearing

	Action	Note
1	 DANGER Make sure that all supplies for electrical power, hydraulic pressure, and air pressure are turned off.	

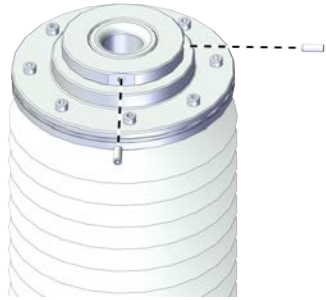
Continues on next page

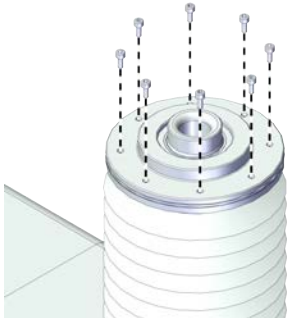
	Action	Note
2	<p> CAUTION</p> <p>For robots with protection type Clean Room Always cut the paint with a knife and grind the paint edge when disassembling parts of the robot! See <i>Cut the paint or surface on the robot before replacing parts on page 118.</i></p>	
3	<p>For robots with protection class IP54 (option 3350-540) For robots with protection type Clean Room (option 3351-1) Loose the locking screws.</p>	 <p>xx2100002398</p>
4	<p>For robots with protection class IP54 (option 3350-540) For robots with protection type Clean Room (option 3351-1) Remove the top cover from the ball screw.</p>	 <p>xx2100002399</p>
5	<p>For robots with protection class IP54 (option 3350-540) For robots with protection type Clean Room (option 3351-1) Remove the screws on the flange with bearing.</p>	 <p>xx2100002401</p>



5 Repair

5.6.9 Replacing the axis-4 timing belt

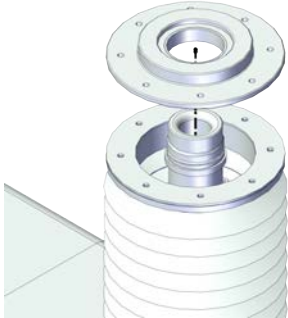

Continued

	Action	Note
6	<p>For robots with protection class IP54 (option 3350-540)</p> <p>For robots with protection type Clean Room (option 3351-1)</p> <p>Remove the flange with bearing.</p>	 <p>xx2100002402</p>



Removing the cover of the outer arm

	Action	Note
1	 <p>DANGER</p> <p>Make sure that all supplies for electrical power, hydraulic pressure, and air pressure are turned off.</p>	
2	 <p>CAUTION</p> <p>For robots with protection type Clean Room</p> <p>Always cut the paint with a knife and grind the paint edge when disassembling parts of the robot! See Cut the paint or surface on the robot before replacing parts on page 118.</p>	

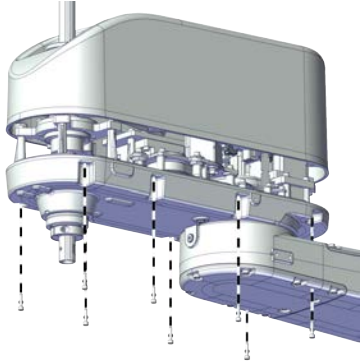
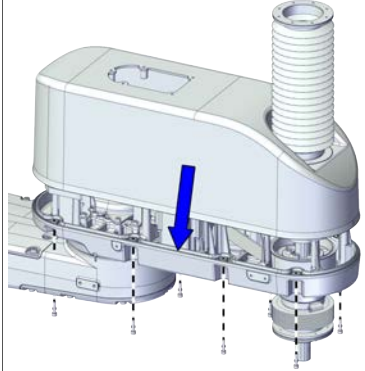
Continues on next page

	Action	Note
3	<p>Remove the screws on the cover of the outer arm and remove the cover.</p> <p> Note</p> <p>For robots with protection class IP54 (option 3350-540) For robots with protection type Clean Room (option 3351-1) Remove the cover with bellow and housing.</p> <p> Note</p> <p>The bellow does not need to be removed separately.</p> <p> Tip</p> <p>Check the gasket and replace it if needed.</p>	<p>For robots with protection class IP30</p>  <p>xx2100000933</p> <p>For robots with protection class IP54 (option 3350-540) For robots with protection type Clean Room (option 3351-1)</p>  <p>xx2100002427</p>

Removing the axis-3 timing belt

	Action	Note
1	<p> DANGER</p> <p>Make sure that all supplies for electrical power, hydraulic pressure, and air pressure are turned off.</p>	
2	<p> CAUTION</p> <p>For robots with protection type Clean Room Always cut the paint with a knife and grind the paint edge when disassembling parts of the robot! See Cut the paint or surface on the robot before replacing parts on page 118.</p>	

Continues on next page



5 Repair

5.6.9 Replacing the axis-4 timing belt

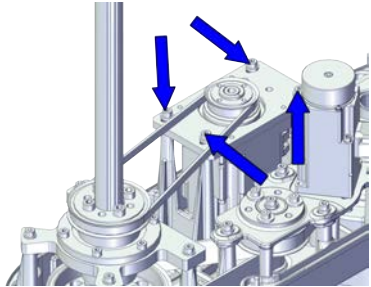
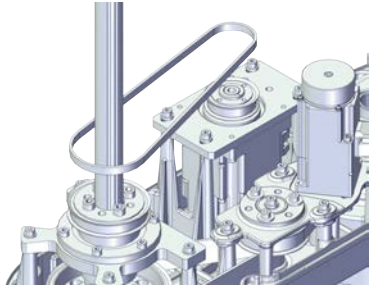
Continued

	Action	Note
3	 DANGER Make sure that the ball screw is supported with something. The sudden drop of the ball screw due the lost of the axis-3 motor may cause danger.	
4	Loosen the screws of the axis-3 motor sub-assembly to let the axis-3 timing belt free.	 xx2100001078
5	Remove the timing belt.	 xx2100001079



Releasing the ball screw flange

	Action	Note
1	 DANGER Make sure that all supplies for electrical power, hydraulic pressure, and air pressure are turned off.	
2	 CAUTION For robots with protection type Clean Room Always cut the paint with a knife and grind the paint edge when disassembling parts of the robot! See <i>Cut the paint or surface on the robot before replacing parts on page 118.</i>	

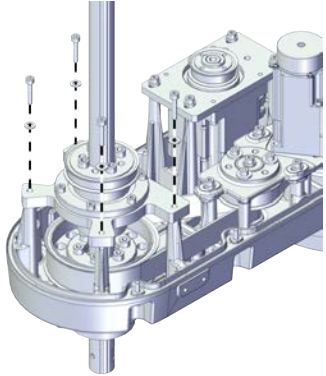
Continues on next page

	Action	Note
3	Removing the screws of the ball screw flange to make enough space for removing the axis-4 second timing belt.	 <p data-bbox="1058 705 1166 725">xx2100001082</p>

Removing the transmission module assembly

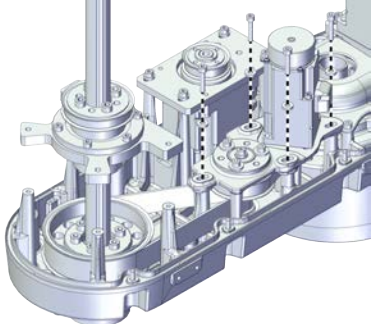
	Action	Note
1	 DANGER Make sure that all supplies for electrical power, hydraulic pressure, and air pressure are turned off.	
2	 CAUTION For robots with protection type Clean Room Always cut the paint with a knife and grind the paint edge when disassembling parts of the robot! See Cut the paint or surface on the robot before replacing parts on page 118 .	
3	Removing the screws of the transmission module assembly.	 <p data-bbox="1058 1675 1166 1695">xx2100001091</p>
4	Take out the transmission module assembly with the axis-4-2 timing belt.	



Continues on next page

5 Repair

5.6.9 Replacing the axis-4 timing belt

Continued

Removing the axis-4 second timing belt

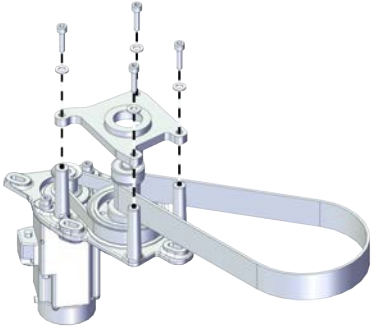
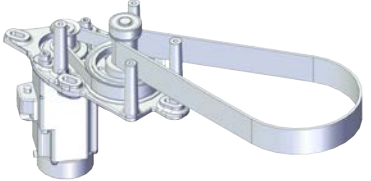
	Action	Note
1	 DANGER Make sure that all supplies for electrical power, hydraulic pressure, and air pressure are turned off.	
2	 CAUTION For robots with protection type Clean Room Always cut the paint with a knife and grind the paint edge when disassembling parts of the robot! See Cut the paint or surface on the robot before replacing parts on page 118 .	
3	Remove the screws and washers on the transmission module flange to let the axis-4 second timing belt be free.	 xx2100001092
4	Remove the timing belt.	 xx2100001093

Removing the axis-4 timing belt

	Action	Note
1	 DANGER Make sure that all supplies for electrical power, hydraulic pressure, and air pressure are turned off.	

Continues on next page

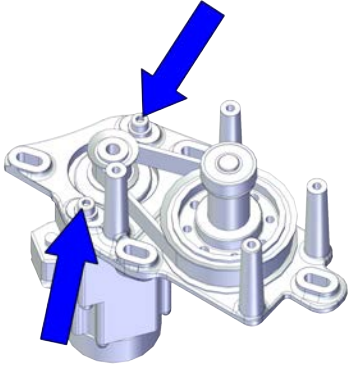
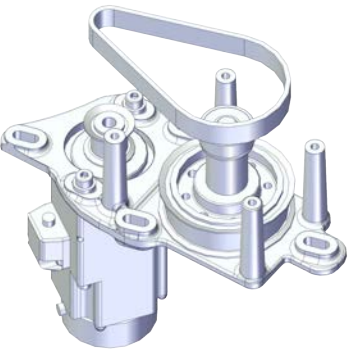
	Action	Note
2	<p> CAUTION</p> <p>For robots with protection type Clean Room Always cut the paint with a knife and grind the paint edge when disassembling parts of the robot! See Cut the paint or surface on the robot before replacing parts on page 118.</p>	
3	<p>Loosen the screws of the axis-4 motor sub-assembly to let the axis-4 timing belt be free.</p>	 <p>xx2100001095</p>
4	<p>Remove the timing belt.</p>	 <p>xx2100001096</p>

Refitting the axis-4 timing belt

Use these procedures to refit the axis-4 timing belt.

Refitting the axis-4 timing belt



	Action	Note
1	<p>For robots with protection type Clean Room: Clean the joints that have been opened and wipe the parts free from particles with spirit on a lint free. See Cut the paint or surface on the robot before replacing parts on page 118</p> <p> Note</p> <p>After all repair work, wipe the Clean Room robot free from particles with spirit on a lint free cloth.</p>	

Continues on next page

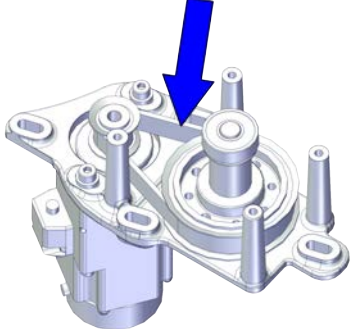
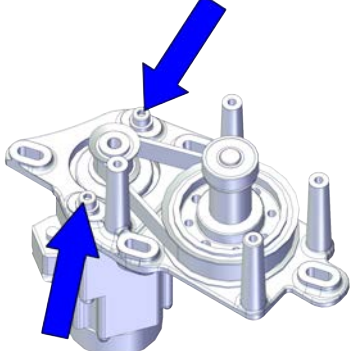

5 Repair

5.6.9 Replacing the axis-4 timing belt

Continued

	Action	Note
2	Refit the timing belt to the pulley.	Timing belt, A4-1: 3HAC070470-001
3	Refit the timing belt to the motor. Ensure that the belt runs correctly in the grooves.	 <p data-bbox="1027 763 1134 786">xx2100001097</p>
4	Refit the screws and washers without fully tightened.	<p data-bbox="1027 824 1406 999">Screws: Hex socket head cap screw M4x16 12.9 Lafre 2C2B/FC6.9 (2 pcs) Washers: Plain washer machining 4.2x9x2 steel (2 pcs) Tightening torque: 2.6 Nm ±10%</p>  <p data-bbox="1027 1384 1134 1406">xx2100001095</p>
5	<p data-bbox="480 1444 1018 1496">Hang a strap to the motor and hold the transmission module.</p> <p data-bbox="480 1518 544 1570"> Note</p> <p data-bbox="480 1585 703 1615">Just tighten the tool.</p>	

Continues on next page

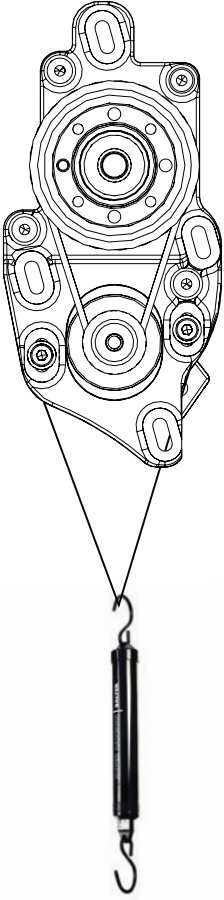
	Action	Note
6	<p>Use a handheld dynamometer hooking to the strap and pull the dynamometer to make the tension falling in the allowed force range.</p> <p> Note</p> <p>During the measurement, make sure that all interferences that may affect the force are removed. Pay attention to the force application direction.</p> <p> Tip</p> <p>If the ball screw will interfere with the handheld dynamometer, adjust the ball screw manually.</p>	 <p>xx2100001128</p>
7	Fasten the screws to the recommended tightening torque.	
8	Use a sonic tension meter to measure the timing belt tension.	Used belt: 312 New belt:245
9	If the timing belt tension does not meet the requirement, loosen the motor screws and readjust.	
10	Remove the axis-4 belt tension adjustment tool.	

Refitting the axis-4 second timing belt to the transmission module

	Action	Note
1	<p>For robots with protection type Clean Room: Clean the joints that have been opened and wipe the parts free from particles with spirit on a lint free. See Cut the paint or surface on the robot before replacing parts on page 118</p> <p> Note</p> <p>After all repair work, wipe the Clean Room robot free from particles with spirit on a lint free cloth.</p>	

Continues on next page

5 Repair

5.6.9 Replacing the axis-4 timing belt

Continued

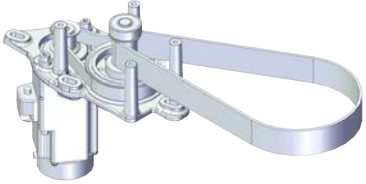
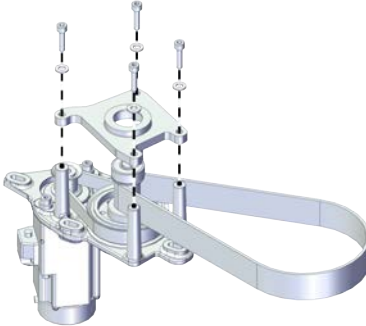
	Action	Note
2	Refit the timing belt to the transmission module.	 <p>xx2100001093</p> <p>Timing belt, A4-2: 3HAC070471-001</p>
3	Refit the transmission module flange and secure with the screws and washers.	<p>Screws: Hex socket head cap screw M4x16 12.9 Lafre 2C2B/FC6.9 (4 pcs) Washers: Spring washer 9x4.3x1 Steel (4 pcs) Tightening torque: 3.5 Nm ±10%</p>  <p>xx2100001092</p>

Refitting the transmission module assembly to the outer arm

	Action	Note
1	<p>For robots with protection type Clean Room: Clean the joints that have been opened and wipe the parts free from particles with spirit on a lint free. See Cut the paint or surface on the robot before replacing parts on page 118</p> <p> Note</p> <p>After all repair work, wipe the Clean Room robot free from particles with spirit on a lint free cloth.</p>	

Continues on next page

5.6.9 Replacing the axis-4 timing belt

Continued

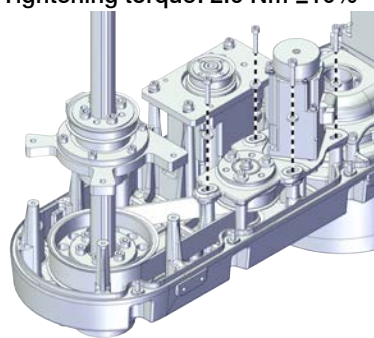
	Action	Note
2	<p>Refit the transmission module assembly to the outer arm.</p> <p> Tip</p> <p>Place the axis-4 second timing belt through the ball screw flange.</p>	<p>Screws: Hex socket head cap screw M4x20 12.9 Lafre 2C2B/FC6.9 (4 pcs)</p> <p>Washers: Plain washer machining 4.2x9x2 steel (4 pcs)</p> <p>Tightening torque: 2.6 Nm ±10%</p>
3	<p>Secure with the screws without fully tightened.</p>	 <p>xx2100001091</p>

Refitting the axis-4 second timing belt to the pulley

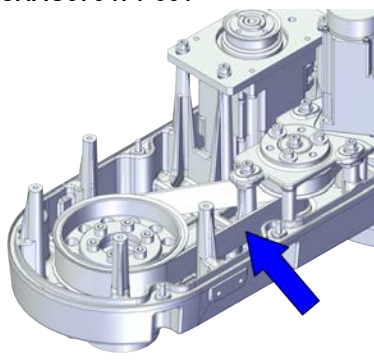
	Action	Note
1	<p>For robots with protection type Clean Room: Clean the joints that have been opened and wipe the parts free from particles with spirit on a lint free. See Cut the paint or surface on the robot before replacing parts on page 118</p> <p> Note</p> <p>After all repair work, wipe the Clean Room robot free from particles with spirit on a lint free cloth.</p>	
2	<p>Refit the belt to the pulley. Ensure that the belt runs correctly in the grooves.</p>	<p>Timing belt, A4-2: 3HAC070471-001</p>  <p>xx2100001086</p>



Continues on next page

5 Repair

5.6.9 Replacing the axis-4 timing belt

Continued

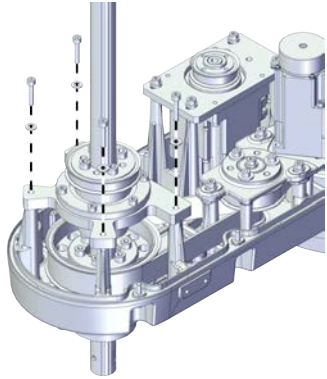

Fastening the ball screw flange

	Action	Note
1	 DANGER Make sure that all supplies for electrical power, hydraulic pressure, and air pressure are turned off.	
2	 CAUTION For robots with protection type Clean Room Always cut the paint with a knife and grind the paint edge when disassembling parts of the robot! See Cut the paint or surface on the robot before replacing parts on page 118 .	
3	 DANGER Make sure that the ball screw is supported with something. The sudden drop of the ball screw due the lost of the axis-3 motor may cause danger.	
4	Tighten the screws of the ball screw flange.	 xx2100001082

Adjusting the axis-4 second timing belt tension

	Action	Note
1	 DANGER Make sure that all supplies for electrical power, hydraulic pressure, and air pressure are turned off.	

Continues on next page

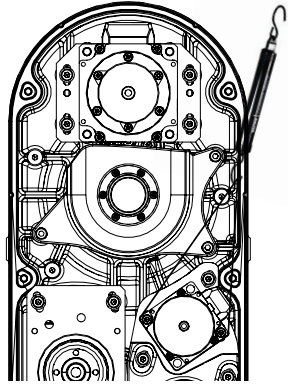
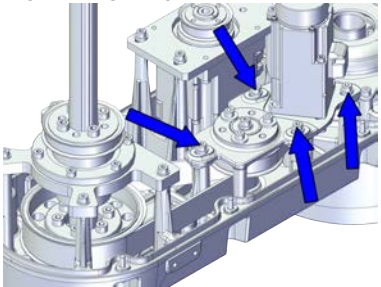
	Action	Note
2	<p> CAUTION</p> <p>For robots with protection type Clean Room Always cut the paint with a knife and grind the paint edge when disassembling parts of the robot! See <i>Cut the paint or surface on the robot before replacing parts on page 118.</i></p>	
3	<p> DANGER</p> <p>Make sure that the ball screw is supported with something. The sudden drop of the ball screw due the lost of the axis-3 motor may cause danger.</p>	
4	<p>Hang a strong strap to the motor.</p>	
5	<p>Use a handheld dynamometer hooking to the strap and pull the dynamometer to make the tension falling in the allowed force range.</p> <p> Note</p> <p>During the measurement, make sure that all interferences that may affect the force are removed. Pay attention to the force application direction.</p>	<p>Used belt: 100 New belt:240</p>  <p>xx2100001127</p>
6	<p>Fasten the screws on the transmission module to the recommended tightening torque.</p>	<p>Tightening torque: 2.6 Nm ±10%</p>  <p>xx2100001087</p>
7	<p>Use a sonic tension meter to measure the timing belt tension.</p>	<p>Used belt: 202 New belt:180</p>
8	<p>If the timing belt tension does not meet the requirement, loosen the motor screws and readjust.</p>	







Continues on next page

5 Repair

5.6.9 Replacing the axis-4 timing belt

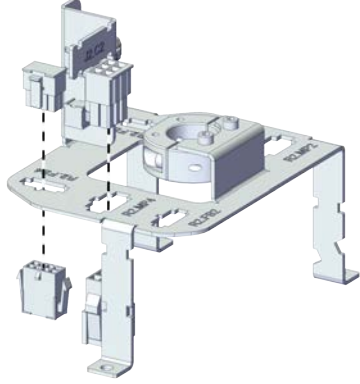
Continued

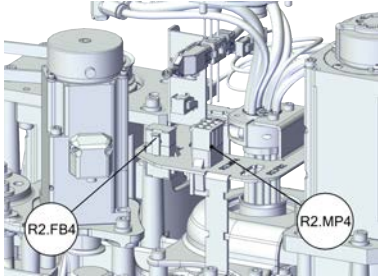
Reconnecting the connectors for axis-4 motor

	Action	Note
1	<p>For robots with protection type Clean Room: Clean the joints that have been opened and wipe the parts free from particles with spirit on a lint free. See Cut the paint or surface on the robot before replacing parts on page 118</p> <p> Note</p> <p>After all repair work, wipe the Clean Room robot free from particles with spirit on a lint free cloth.</p>	
	<p>Insert the female head of the connectors to the bracket accordingly.</p> <p> Tip</p> <p>The mistake proofing measure has been applied to the connectors, the connectors may be damaged if excessive force is used.</p> <p> Note</p> <p>The harness are not visible due to the cleanness requirements of the illustration. They are still existing inside the cable ferrule in the actual situation.</p>	 <p>xx210000939</p>
2	<p>Reconnect the connectors.</p> <ul style="list-style-type: none"> • R2.MP4 • R2.FB4 <p> Tip</p> <p>See the number markings on the connectors for help to find the corresponding connector.</p>	 <p>xx210000938</p>
3	<p>Route the cabling on the axis-4 motor.</p> <p> CAUTION</p> <p>Correct cable routing is highly important. If the cables are routed and secured incorrectly the cables can be damaged.</p>	

Continues on next page

Refitting the axis-3 timing belt

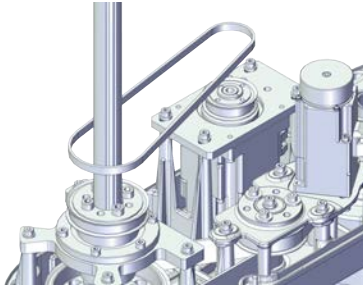
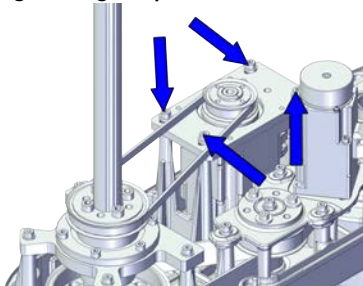
	Action	Note
1	<p>For robots with protection type Clean Room: Clean the joints that have been opened and wipe the parts free from particles with spirit on a lint free. See Cut the paint or surface on the robot before replacing parts on page 118</p> <p> Note</p> <p>After all repair work, wipe the Clean Room robot free from particles with spirit on a lint free cloth.</p>	
2	<p>Refit the timing belt to the pulley on the ball screw and the motor. Ensure that the belt runs correctly in the grooves.</p>	<p>Timing belt A3: 3HAC070464-001</p>  <p>xx2100001079</p>
3	<p>Secure the screws and washers without fully tightened.</p>	<p>Screws: Hex socket head cap screw M4x16 12.9 Lafre 2C2B/FC6.9 (4 pcs) Washers: Plain washer machining 4.2x9x2 steel (4 pcs) Tightening torque: 2.6 Nm ±10%</p>  <p>xx2100001078</p>
4	<p>Hang a strap to the hook on the motor.</p>	

Continues on next page

5 Repair

5.6.9 Replacing the axis-4 timing belt

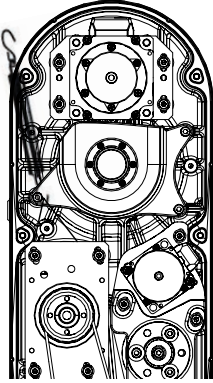

Continued

	Action	Note
5	<p>Use a handheld dynamometer hooking to the strap and pull the dynamometer to make the tension falling in the allowed force range.</p> <p> Note</p> <p>During the measurement, make sure that all interferences that may affect the force are removed. Pay attention to the force application direction.</p>	<p>Used belt: 36.6 New belt:40</p>  <p>xx2100001126</p>
6	Use a sonic tension meter to measure the timing belt tension.	Used belt: 139 New belt:110
7	If the timing belt tension does not meet the requirement, loosen the motor screws and readjust.	

Refitting the cover of the outer arm

	Action	Note
1	<p>For robots with protection type Clean Room: Clean the joints that have been opened and wipe the parts free from particles with spirit on a lint free. See Cut the paint or surface on the robot before replacing parts on page 118</p> <p> Note</p> <p>After all repair work, wipe the Clean Room robot free from particles with spirit on a lint free cloth.</p>	

Continues on next page

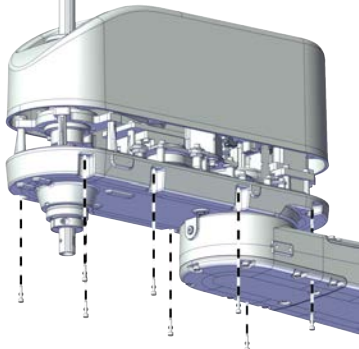
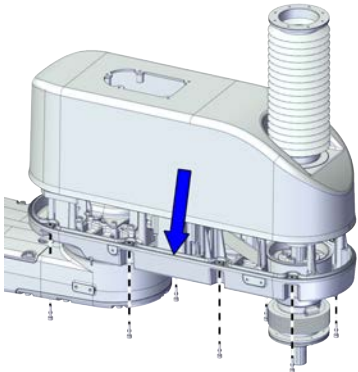
	Action	Note
2	<p>Refit the cover.</p> <p> Note</p> <p>For robots with protection class IP54 (option 3350-540)</p> <p>For robots with protection type Clean Room (option 3351-1)</p> <p>Refit the cover with bellow.</p> <p>Check the gasket for the outer arm cover.</p> <p> Tip</p> <p>Replace the gasket if needed.</p> <p> CAUTION</p> <p>The gasket is in the outer arm.</p>	<p>Screw: Hex socket head cap screw M4x16 12.9 Lafre 2C2B/FC6.9 (8 pcs)</p> <p>Tightening torque: 2 Nm ±10%</p> <p>For robots with protection class IP30 (option 3350-300)</p>  <p>xx210000933</p>
3	<p>Refit the screws.</p>	<p>For robots with protection class IP54 (option 3350-540)</p> <p>For robots with protection type Clean Room (option 3351-1)</p>  <p>xx2100002427</p>

For Clean Room/ IP54 robots

Refitting the top cover and the flange with bearing



	Action	Note
1	<p>For robots with protection type Clean Room:</p> <p>Clean the joints that have been opened and wipe the parts free from particles with spirit on a lint free. See Cut the paint or surface on the robot before replacing parts on page 118</p> <p> Note</p> <p>After all repair work, wipe the Clean Room robot free from particles with spirit on a lint free cloth.</p>	

Continues on next page

5 Repair

5.6.9 Replacing the axis-4 timing belt

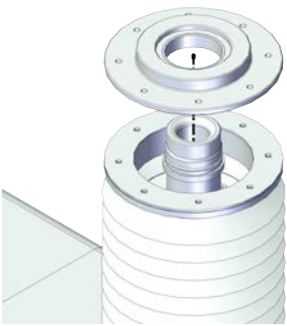
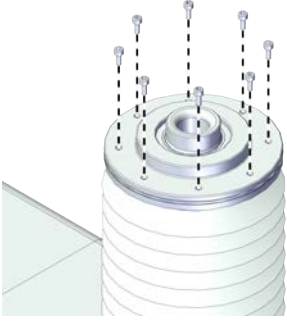
Continued

	Action	Note
2	<p>For robots with protection class IP54 (option 3350-540)</p> <p>For robots with protection type Clean Room (option 3351-1)</p> <p>Install the flange with bearing to the extension shaft.</p>	 <p>xx2100002402</p>
3	<p>For robots with protection class IP54 (option 3350-540)</p> <p>For robots with protection type Clean Room (option 3351-1)</p> <p>Refit the screws to the flange with bearing.</p>	<p>Screws: Hex socket head cap screw M2.5x6 12.9 Lafre 2C2B/FC6.9 (8 pcs)</p> <p>Tightening torque: 0.8 Nm \pm10%</p>  <p>xx2100002401</p>
4	<p>For robots with protection class IP54 (option 3350-540)</p> <p>For robots with protection type Clean Room (option 3351-1)</p> <p>Refit the top cover to the ball screw.</p> <p> Tip</p> <p>The top surface of the cover should be flush with the top end of the ball screw.</p>	 <p>xx2100002399</p>

Continues on next page

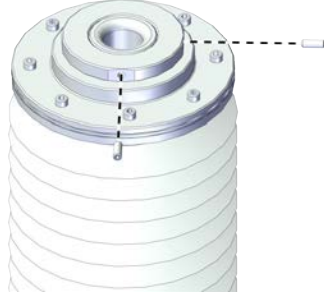
	Action	Note
5	<p>For robots with protection class IP54 (option 3350-540) For robots with protection type Clean Room (option 3351-1) Refit the locking screws.</p>	<p>Screws: Hexagon socket set screws with flat point, ISO 4026 stainless steel M3x8 (2 pcs) Tightening torque: 0.4 Nm ±10%</p>  <p>xx2100002398</p>



Securing the process hub to outer arm cover

	Action	Note
1	<p>For robots with protection type Clean Room: Clean the joints that have been opened and wipe the parts free from particles with spirit on a lint free. See Cut the paint or surface on the robot before replacing parts on page 118</p> <p> Note</p> <p>After all repair work, wipe the Clean Room robot free from particles with spirit on a lint free cloth.</p>	
2	<p>Insert the process hub from the outer arm cover.</p>	

5 Repair

5.6.9 Replacing the axis-4 timing belt

Continued

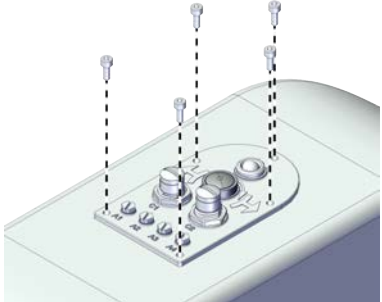
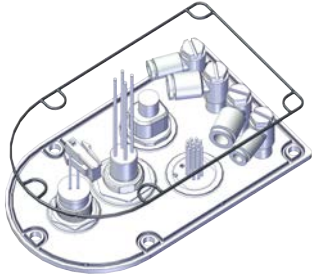
	Action	Note
3	<p>Secure the process hub to the outer arm cover with the screws.</p> <p> Note</p> <p>For robots with protection class IP54 (option 3350-540)</p> <p>For robots with protection type Clean Room (option 3351-1)</p> <p>Check the gasket for the process hub.</p> <p> Tip</p> <p>Replace the gasket if needed.</p> <p> CAUTION</p> <p>Be aware of the cabling that is attached to the cover! The cover can not be removed completely until the connectors are disconnected, as shown in following steps.</p>	<p>Screws: Hex socket head cap screw M4x10 12.9 Lafre 2C2B/FC6.9 (5 pcs)</p> <p>Tightening torque: 2.6 Nm±10%</p> <p>For robots with protection class IP30 (option 3350-300)</p>  <p>xx2100000932</p> <p>For robots with protection class IP54 (option 3350-540)</p> <p>For robots with protection type Clean Room (option 3351-1)</p>  <p>xx2100002438</p>

Concluding procedure

	Action	Note
1	<p>For robots with protection type Clean Room: Seal and paint the joints that have been opened. See Cut the paint or surface on the robot before replacing parts on page 118</p> <p> Note</p> <p>After all repair work, wipe the Clean Room robot free from particles with spirit on a lint free cloth.</p>	
2	Recalibrate the robot.	Calibration is detailed in section Calibration on page 945 .

Continues on next page

	Action	Note
3	 DANGER Make sure all safety requirements are met when performing the first test run.	

5 Repair

5.6.10 Replacing the transmission module

5.6.10 Replacing the transmission module

Location of the transmission module

The transmission module is located as shown in the figure.

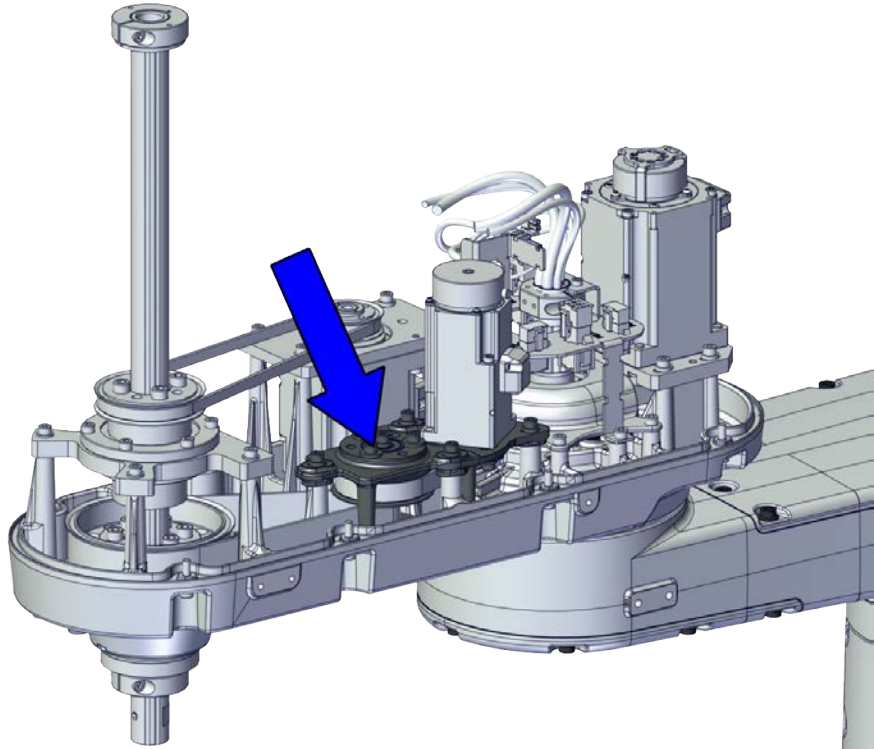

xx2100001018

Required spare parts



Note

The spare part numbers that are listed in the table can be out of date. See the latest spare parts of the IRB 920 via myABB Business Portal, www.abb.com/myABB.

Spare part	Article number	Note
Transmission module	3HAC076579-001	

Required tools and equipment

Equipment	Article number	Note
Standard toolkit	-	Content is defined in section Standard toolkit on page 996 .
Calibration toolbox, Axis Calibration	3HAC055412-001	Delivered as a set of calibration tools. Required if Axis Calibration is the valid calibration method for the robot.

Continues on next page

Equipment	Article number	Note
24 VDC power supply	-	Used to release the motor brakes.
Sonic tension meter	-	Used for measuring the timing belt tension.
Handheld dynamometer	-	Used for measuring the timing belt tension.

Required consumables

Consumable	Article number	Note
Cable straps	-	

Deciding calibration routine

Decide which calibration routine to be used, based on the information in the table. Depending on which routine is chosen, action might be required prior to beginning the repair work of the robot, see the table.

	Action	Note
1	<p>Decide which calibration routine to use for calibrating the robot.</p> <ul style="list-style-type: none"> Reference calibration. External cable packages (DressPack) and tools can stay fitted on the robot. Fine calibration. All external cable packages (DressPack) and tools must be removed from the robot. 	
	<p>If the robot is to be calibrated with reference calibration:</p> <p>Find previous reference values for the axis or create new reference values. These values are to be used after the repair procedure is completed, for calibration of the robot.</p> <p>If no previous reference values exist, and no new reference values can be created, then reference calibration is not possible.</p>	<p>Follow the instructions given in the reference calibration routine on the FlexPendant to create reference values.</p> <p>Creating new values requires possibility to move the robot.</p> <p>Read more about reference calibration for Axis Calibration in Reference calibration routine on page 957.</p>
	<p>If the robot is to be calibrated with fine calibration:</p> <p>Remove all external cable packages (DressPack) and tools from the robot.</p>	

Removing the transmission module

Use these procedures to remove the transmission module.

Preparations before removing the transmission module



	Action	Note
1	Decide which calibration routine to use, and take actions accordingly prior to beginning the repair procedure.	

Continues on next page

5 Repair

5.6.10 Replacing the transmission module

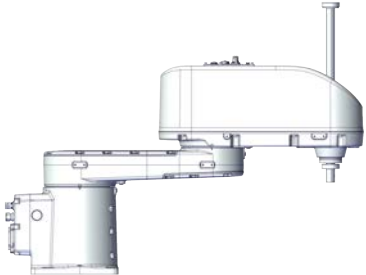

Continued

	Action	Note
2	<p>If there is no enough space for the maintenance work, remove the robot from the wall and place it on the maintenance bracket.</p> <p> CAUTION</p> <p>Do not lay down the robot during the transportation, always keep it straight. If the robot lay down in any situation, the grease may come out from gearbox.</p>	
3	<p>Jog all axes to zero position.</p>	 <p>xx2100000930</p>
4	<p> DANGER</p> <p>Turn off all:</p> <ul style="list-style-type: none"> • electric power supply • hydraulic pressure supply • air pressure supply <p>to the robot, before entering the safeguarded space.</p>	
5	<p> CAUTION</p> <p>For robots with protection type Clean Room Always cut the paint with a knife and grind the paint edge when disassembling parts of the robot! See Cut the paint or surface on the robot before replacing parts on page 118.</p>	

Removing the process hub screws

	Action	Note
1	<p> DANGER</p> <p>Make sure that all supplies for electrical power, hydraulic pressure, and air pressure are turned off.</p>	

Continues on next page

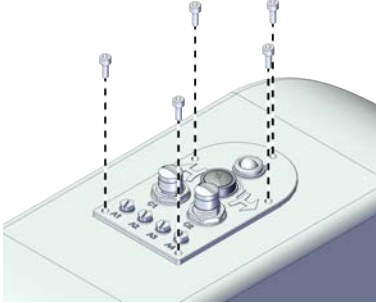
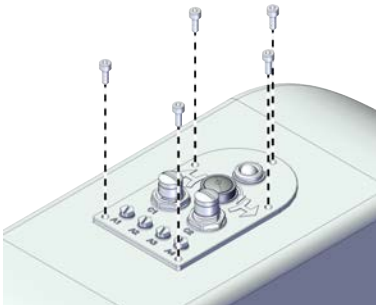
	Action	Note
2	<p> CAUTION</p> <p>For robots with protection type Clean Room Always cut the paint with a knife and grind the paint edge when disassembling parts of the robot! See <i>Cut the paint or surface on the robot before replacing parts on page 118.</i></p>	
3	<p>Remove the screws on the process hub.</p> <p> Note</p> <p>For robots with protection class IP54 (option 3350-540) For robots with protection type Clean Room (option 3351-1) Remove the screws on the process hub and take out the gasket.</p> <p> Tip</p> <p>Check the gasket and replace it if needed.</p>	<p>For robots with protection class IP30</p>  <p>xx2100000932</p> <p>For robots with protection class IP54 (option 3350-540) For robots with protection type Clean Room (option 3351-1)</p>  <p>xx2100000932</p>
4	Insert the process hub to the outer arm.	

For Clean Room/ IP54 robots

Removing the top cover and the flange with bearing



	Action	Note
1	<p> DANGER</p> <p>Make sure that all supplies for electrical power, hydraulic pressure, and air pressure are turned off.</p>	

Continues on next page

5 Repair

5.6.10 Replacing the transmission module

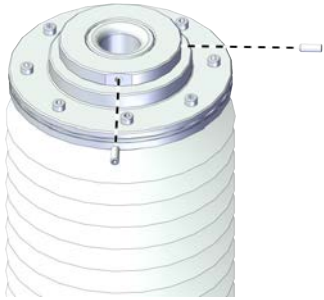

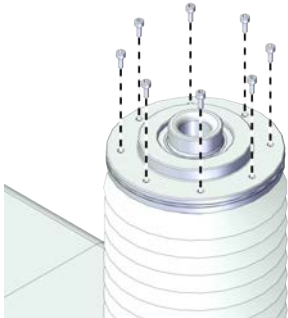
Continued

	Action	Note
2	<p> CAUTION</p> <p>For robots with protection type Clean Room Always cut the paint with a knife and grind the paint edge when disassembling parts of the robot! See <i>Cut the paint or surface on the robot before replacing parts on page 118.</i></p>	
3	<p>For robots with protection class IP54 (option 3350-540) For robots with protection type Clean Room (option 3351-1) Loose the locking screws.</p>	 <p>xx2100002398</p>
4	<p>For robots with protection class IP54 (option 3350-540) For robots with protection type Clean Room (option 3351-1) Remove the top cover from the ball screw.</p>	 <p>xx2100002399</p>
5	<p>For robots with protection class IP54 (option 3350-540) For robots with protection type Clean Room (option 3351-1) Remove the screws on the flange with bearing.</p>	 <p>xx2100002401</p>

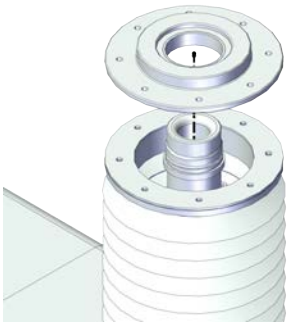
Continues on next page

	Action	Note
6	<p>For robots with protection class IP54 (option 3350-540) For robots with protection type Clean Room (option 3351-1) Remove the flange with bearing.</p>	 <p>xx2100002402</p>



Removing the cover of the outer arm

	Action	Note
1	<p> DANGER</p> <p>Make sure that all supplies for electrical power, hydraulic pressure, and air pressure are turned off.</p>	
2	<p> CAUTION</p> <p>For robots with protection type Clean Room Always cut the paint with a knife and grind the paint edge when disassembling parts of the robot! See Cut the paint or surface on the robot before replacing parts on page 118.</p>	



5 Repair

5.6.10 Replacing the transmission module

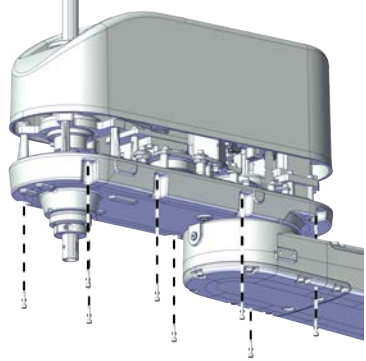
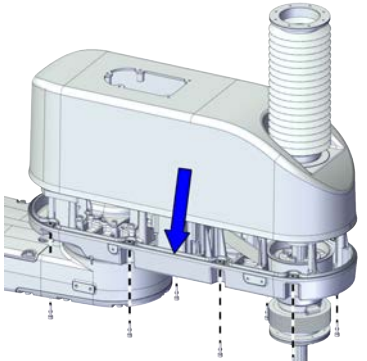
Continued

	Action	Note
3	<p>Remove the screws on the cover of the outer arm and remove the cover.</p> <p> Note</p> <p>For robots with protection class IP54 (option 3350-540) For robots with protection type Clean Room (option 3351-1) Remove the cover with bellow and housing.</p> <p> Note</p> <p>The bellow does not need to be removed separately.</p> <p> Tip</p> <p>Check the gasket and replace it if needed.</p>	<p>For robots with protection class IP30</p>  <p>xx210000933</p> <p>For robots with protection class IP54 (option 3350-540) For robots with protection type Clean Room (option 3351-1)</p>  <p>xx2100002427</p>



Removing the axis-3 timing belt

	Action	Note
1	<p> DANGER</p> <p>Make sure that all supplies for electrical power, hydraulic pressure, and air pressure are turned off.</p>	
2	<p> CAUTION</p> <p>For robots with protection type Clean Room Always cut the paint with a knife and grind the paint edge when disassembling parts of the robot! See Cut the paint or surface on the robot before replacing parts on page 118.</p>	

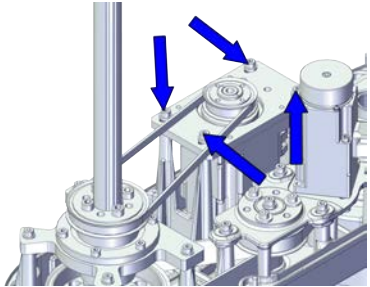
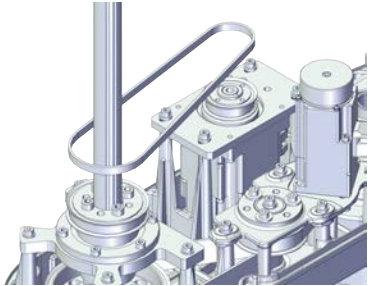
Continues on next page

	Action	Note
3	 <p>DANGER</p> <p>Make sure that the ball screw is supported with something. The sudden drop of the ball screw due the lost of the axis-3 motor may cause danger.</p>	
4	<p>Loosen the screws of the axis-3 motor sub-assembly to let the axis-3 timing belt free.</p>	 <p>xx2100001078</p>
5	<p>Remove the timing belt.</p>	 <p>xx2100001079</p>

Releasing the ball screw flange

	Action	Note
1	 <p>DANGER</p> <p>Make sure that all supplies for electrical power, hydraulic pressure, and air pressure are turned off.</p>	
2	 <p>CAUTION</p> <p>For robots with protection type Clean Room Always cut the paint with a knife and grind the paint edge when disassembling parts of the robot! See <i>Cut the paint or surface on the robot before replacing parts on page 118.</i></p>	

Continues on next page



5 Repair

5.6.10 Replacing the transmission module

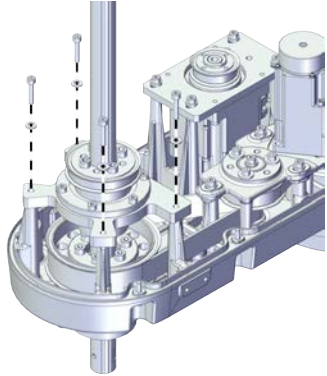
Continued

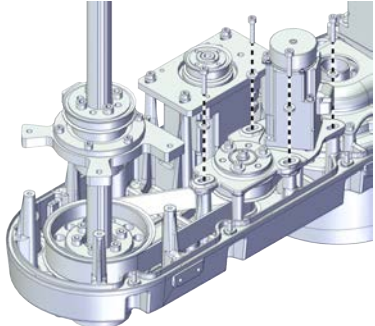

	Action	Note
3	Removing the screws of the ball screw flange to make enough space for removing the axis-4 second timing belt.	 <p>xx2100001082</p>

Removing the transmission module assembly

	Action	Note
1	 DANGER Make sure that all supplies for electrical power, hydraulic pressure, and air pressure are turned off.	
2	 CAUTION For robots with protection type Clean Room Always cut the paint with a knife and grind the paint edge when disassembling parts of the robot! See Cut the paint or surface on the robot before replacing parts on page 118 .	
3	Removing the screws of the transmission module assembly.	 <p>xx2100001091</p>
4	Take out the transmission module assembly with the axis-4-2 timing belt.	

Continues on next page

Removing the axis-4 second timing belt

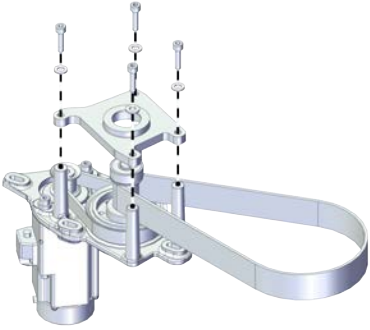
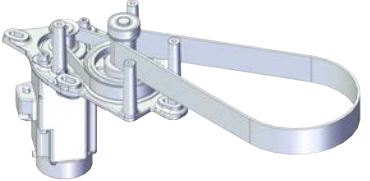
	Action	Note
1	 DANGER Make sure that all supplies for electrical power, hydraulic pressure, and air pressure are turned off.	
2	 CAUTION For robots with protection type Clean Room Always cut the paint with a knife and grind the paint edge when disassembling parts of the robot! See Cut the paint or surface on the robot before replacing parts on page 118 .	
3	Remove the screws and washers on the transmission module flange to let the axis-4 second timing belt be free.	 xx2100001092
4	Remove the timing belt.	 xx2100001093

Removing the axis-4 motor sub-assembly



	Action	Note
1	 DANGER Make sure that all supplies for electrical power, hydraulic pressure, and air pressure are turned off.	

Continues on next page

5 Repair

5.6.10 Replacing the transmission module

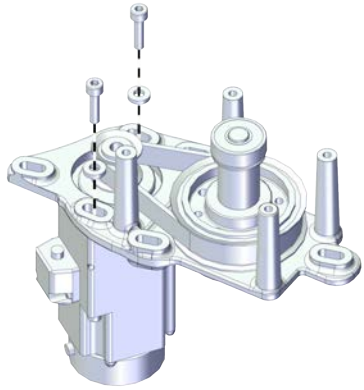
Continued

	Action	Note
2	 CAUTION For robots with protection type Clean Room Always cut the paint with a knife and grind the paint edge when disassembling parts of the robot! See Cut the paint or surface on the robot before replacing parts on page 118 .	
3	Remove the screws and washers.	 xx2100001094
4	Remove the motor from the transmission module.  Tip Move the internal harness out of the way.	
5	Remove the timing belt from the transmission module.	

Refitting the transmission module

Use these procedures to refit the transmission module.

Refitting the axis-4 motor sub-assembly to the transmission module

	Action	Note
1	For robots with protection type Clean Room: Clean the joints that have been opened and wipe the parts free from particles with spirit on a lint free. See Cut the paint or surface on the robot before replacing parts on page 118  Note After all repair work, wipe the Clean Room robot free from particles with spirit on a lint free cloth.	

Continues on next page

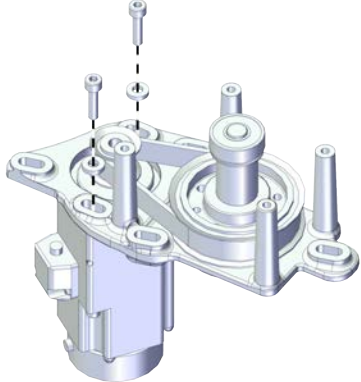
	Action	Note
2	Refit the motor to the transmission module.  Tip Move the internal harness out of the way.	Screws: Hex socket head cap screw M4x16 12.9 Lafre 2C2B/FC6.9 (2 pcs) Washers: Washer 4.3x10x2 steel (2 pcs) Tightening torque: 2.6 Nm ±10%
3	Refit the screws and washers.	 <p>xx2100001094</p>

Refitting the axis-4 timing belt

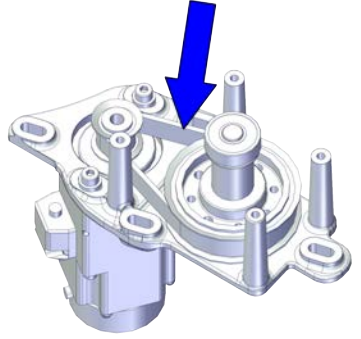

	Action	Note
1	For robots with protection type Clean Room: Clean the joints that have been opened and wipe the parts free from particles with spirit on a lint free. See Cut the paint or surface on the robot before replacing parts on page 118  Note After all repair work, wipe the Clean Room robot free from particles with spirit on a lint free cloth.	
2	Refit the timing belt to the pulley.	Timing belt, A4-1:
3	Refit the timing belt to the motor. Ensure that the belt runs correctly in the grooves.	3HAC070470-001  <p>xx2100001097</p>

Continues on next page

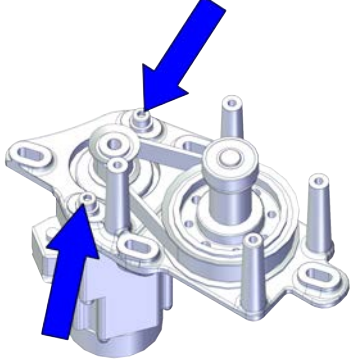

5 Repair

5.6.10 Replacing the transmission module

Continued

	Action	Note
4	Refit the screws and washers without fully tightened.	<p>Screws: Hex socket head cap screw M4x16 12.9 Lafre 2C2B/FC6.9 (2 pcs) Washers: Plain washer machining 4.2x9x2 steel (2 pcs) Tightening torque: 2.6 Nm \pm10%</p>  <p>xx2100001095</p>
5	Hang a strap to the motor and hold the transmission module.  Note Just tighten the tool.	

Continues on next page

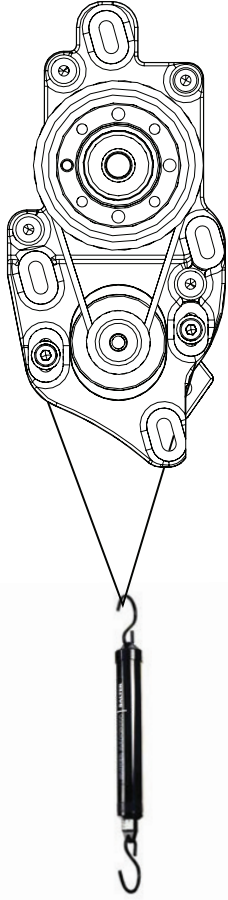
	Action	Note
6	<p>Use a handheld dynamometer hooking to the strap and pull the dynamometer to make the tension falling in the allowed force range.</p> <p> Note</p> <p>During the measurement, make sure that all interferences that may affect the force are removed. Pay attention to the force application direction.</p> <p> Tip</p> <p>If the ball screw will interfere with the handheld dynamometer, adjust the ball screw manually.</p>	 <p>xx2100001128</p>
7	Fasten the screws to the recommended tightening torque.	
8	Use a sonic tension meter to measure the timing belt tension.	Used belt: 312 New belt:245
9	If the timing belt tension does not meet the requirement, loosen the motor screws and readjust.	
10	Remove the axis-4 belt tension adjustment tool.	

Refitting the axis-4 second timing belt to the transmission module

	Action	Note
1	<p>For robots with protection type Clean Room: Clean the joints that have been opened and wipe the parts free from particles with spirit on a lint free. See Cut the paint or surface on the robot before replacing parts on page 118</p> <p> Note</p> <p>After all repair work, wipe the Clean Room robot free from particles with spirit on a lint free cloth.</p>	

Continues on next page

5 Repair

5.6.10 Replacing the transmission module

Continued

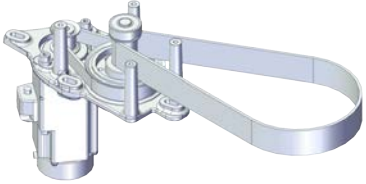
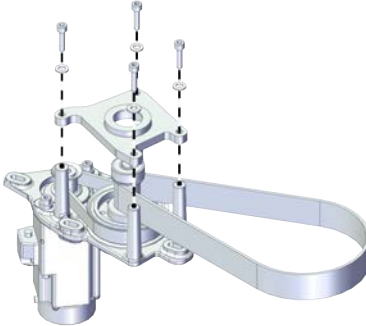
	Action	Note
2	Refit the timing belt to the transmission module.	 <p data-bbox="1034 533 1136 551">xx2100001093</p> <p data-bbox="1034 568 1225 629">Timing belt, A4-2: 3HAC070471-001</p>
3	Refit the transmission module flange and secure with the screws and washers.	<p data-bbox="1034 651 1358 730">Screws: Hex socket head cap screw M4x16 12.9 Lafre 2C2B/FC6.9 (4 pcs)</p> <p data-bbox="1034 734 1390 790">Washers: Spring washer 9x4.3x1 Steel (4 pcs)</p> <p data-bbox="1034 795 1390 824">Tightening torque: 3.5 Nm ±10%</p>  <p data-bbox="1034 1167 1136 1184">xx2100001092</p>

Refitting the transmission module assembly to the outer arm

	Action	Note
1	<p data-bbox="485 1339 1018 1480">For robots with protection type Clean Room: Clean the joints that have been opened and wipe the parts free from particles with spirit on a lint free. See Cut the paint or surface on the robot before replacing parts on page 118</p> <p data-bbox="485 1503 544 1554"> Note</p> <p data-bbox="485 1570 1018 1626">After all repair work, wipe the Clean Room robot free from particles with spirit on a lint free cloth.</p>	

Continues on next page

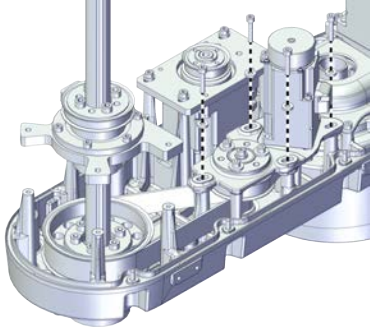
	Action	Note
2	<p>Refit the transmission module assembly to the outer arm.</p>  Tip Place the axis-4 second timing belt through the ball screw flange.	<p>Screws: Hex socket head cap screw M4x20 12.9 Lafre 2C2B/FC6.9 (4 pcs) Washers: Plain washer machining 4.2x9x2 steel (4 pcs) Tightening torque: 2.6 Nm ±10%</p>
3	<p>Secure with the screws without fully tightened.</p>	 <p>xx2100001091</p>

Refitting the axis-4 second timing belt to the pulley

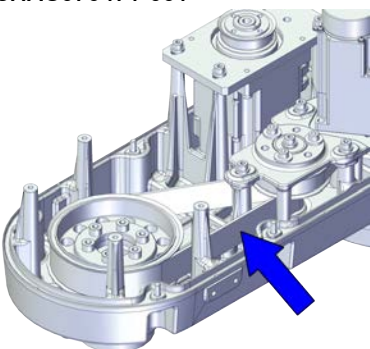
	Action	Note
1	<p>For robots with protection type Clean Room: Clean the joints that have been opened and wipe the parts free from particles with spirit on a lint free. See Cut the paint or surface on the robot before replacing parts on page 118</p>  Note After all repair work, wipe the Clean Room robot free from particles with spirit on a lint free cloth.	
2	<p>Refit the belt to the pulley. Ensure that the belt runs correctly in the grooves.</p>	<p>Timing belt, A4-2: 3HAC070471-001</p>  <p>xx2100001086</p>



Continues on next page

5 Repair

5.6.10 Replacing the transmission module

Continued

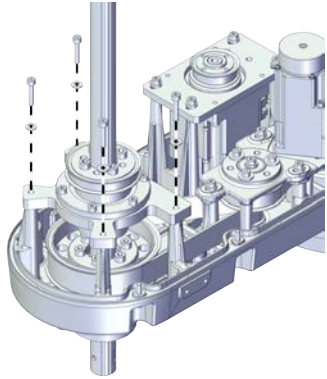

Fastening the ball screw flange

	Action	Note
1	 DANGER Make sure that all supplies for electrical power, hydraulic pressure, and air pressure are turned off.	
2	 CAUTION For robots with protection type Clean Room Always cut the paint with a knife and grind the paint edge when disassembling parts of the robot! See Cut the paint or surface on the robot before replacing parts on page 118 .	
3	 DANGER Make sure that the ball screw is supported with something. The sudden drop of the ball screw due the lost of the axis-3 motor may cause danger.	
4	Tighten the screws of the ball screw flange.	 xx2100001082

Adjusting the axis-4 second timing belt tension

	Action	Note
1	 DANGER Make sure that all supplies for electrical power, hydraulic pressure, and air pressure are turned off.	

Continues on next page

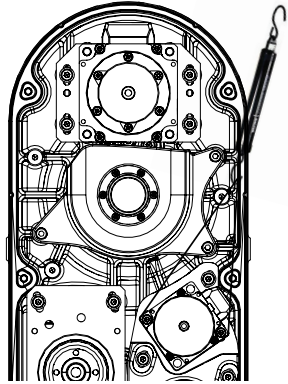
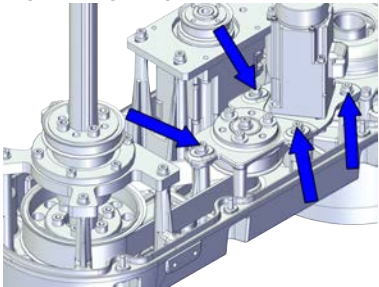
	Action	Note
2	<p> CAUTION</p> <p>For robots with protection type Clean Room Always cut the paint with a knife and grind the paint edge when disassembling parts of the robot! See <i>Cut the paint or surface on the robot before replacing parts on page 118.</i></p>	
3	<p> DANGER</p> <p>Make sure that the ball screw is supported with something. The sudden drop of the ball screw due the lost of the axis-3 motor may cause danger.</p>	
4	Hang a strong strap to the motor.	
5	<p>Use a handheld dynamometer hooking to the strap and pull the dynamometer to make the tension falling in the allowed force range.</p> <p> Note</p> <p>During the measurement, make sure that all interferences that may affect the force are removed. Pay attention to the force application direction.</p>	<p>Used belt: 100 New belt:240</p>  <p>xx2100001127</p>
6	Fasten the screws on the transmission module to the recommended tightening torque.	<p>Tightening torque: 2.6 Nm \pm10%</p>  <p>xx2100001087</p>
7	Use a sonic tension meter to measure the timing belt tension.	<p>Used belt: 202 New belt:180</p>
8	If the timing belt tension does not meet the requirement, loosen the motor screws and readjust.	







Continues on next page

5 Repair

5.6.10 Replacing the transmission module

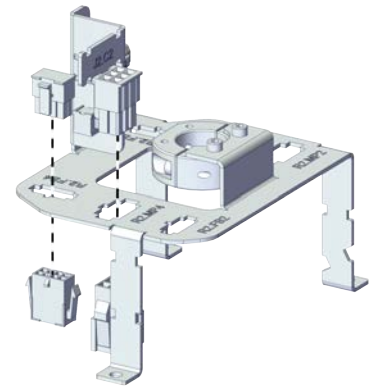
Continued

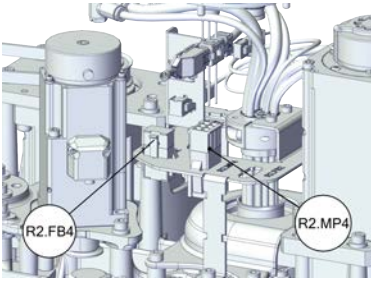
Reconnecting the connectors for axis-4 motor

	Action	Note
1	<p>For robots with protection type Clean Room: Clean the joints that have been opened and wipe the parts free from particles with spirit on a lint free. See Cut the paint or surface on the robot before replacing parts on page 118</p> <p> Note</p> <p>After all repair work, wipe the Clean Room robot free from particles with spirit on a lint free cloth.</p>	
	<p>Insert the female head of the connectors to the bracket accordingly.</p> <p> Tip</p> <p>The mistake proofing measure has been applied to the connectors, the connectors may be damaged if excessive force is used.</p> <p> Note</p> <p>The harness are not visible due to the cleanness requirements of the illustration. They are still existing inside the cable ferrule in the actual situation.</p>	 <p>xx210000939</p>
2	<p>Reconnect the connectors.</p> <ul style="list-style-type: none"> • R2.MP4 • R2.FB4 <p> Tip</p> <p>See the number markings on the connectors for help to find the corresponding connector.</p>	 <p>xx210000938</p>
3	<p>Route the cabling on the axis-4 motor.</p> <p> CAUTION</p> <p>Correct cable routing is highly important. If the cables are routed and secured incorrectly the cables can be damaged.</p>	

Continues on next page

Refitting the axis-3 timing belt

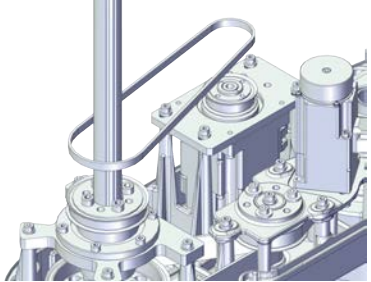
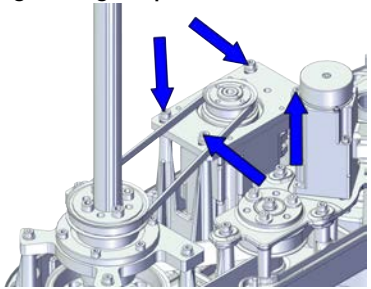
	Action	Note
1	<p>For robots with protection type Clean Room: Clean the joints that have been opened and wipe the parts free from particles with spirit on a lint free. See Cut the paint or surface on the robot before replacing parts on page 118</p> <p> Note</p> <p>After all repair work, wipe the Clean Room robot free from particles with spirit on a lint free cloth.</p>	
2	<p>Refit the timing belt to the pulley on the ball screw and the motor. Ensure that the belt runs correctly in the grooves.</p>	<p>Timing belt A3: 3HAC070464-001</p>  <p>xx2100001079</p>
3	<p>Secure the screws and washers without fully tightened.</p>	<p>Screws: Hex socket head cap screw M4x16 12.9 Lafre 2C2B/FC6.9 (4 pcs) Washers: Plain washer machining 4.2x9x2 steel (4 pcs) Tightening torque: 2.6 Nm ±10%</p>  <p>xx2100001078</p>
4	<p>Hang a strap to the hook on the motor.</p>	

Continues on next page

5 Repair

5.6.10 Replacing the transmission module

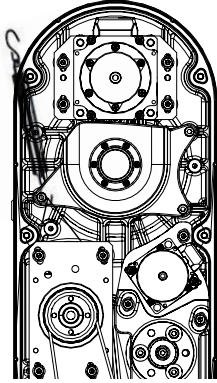

Continued

	Action	Note
5	<p>Use a handheld dynamometer hooking to the strap and pull the dynamometer to make the tension falling in the allowed force range.</p> <p> Note</p> <p>During the measurement, make sure that all interferences that may affect the force are removed. Pay attention to the force application direction.</p>	<p>Used belt: 36.6 New belt:40</p>  <p>xx2100001126</p>
6	Use a sonic tension meter to measure the timing belt tension.	Used belt: 139 New belt:110
7	If the timing belt tension does not meet the requirement, loosen the motor screws and readjust.	

Refitting the cover of the outer arm

	Action	Note
1	<p>For robots with protection type Clean Room: Clean the joints that have been opened and wipe the parts free from particles with spirit on a lint free. See Cut the paint or surface on the robot before replacing parts on page 118</p> <p> Note</p> <p>After all repair work, wipe the Clean Room robot free from particles with spirit on a lint free cloth.</p>	

Continues on next page

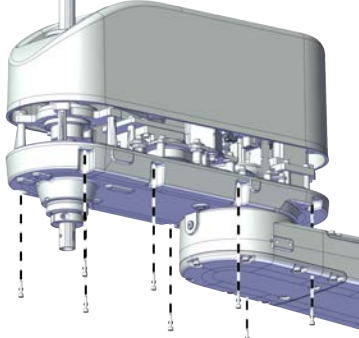
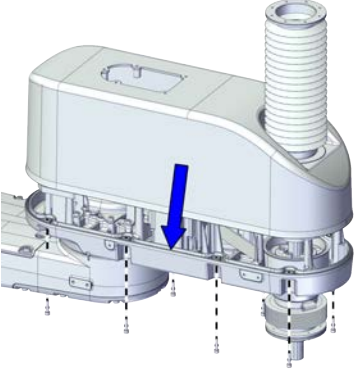
	Action	Note
2	<p>Refit the cover.</p> <p> Note</p> <p>For robots with protection class IP54 (option 3350-540)</p> <p>For robots with protection type Clean Room (option 3351-1)</p> <p>Refit the cover with bellow.</p> <p>Check the gasket for the outer arm cover.</p> <p> Tip</p> <p>Replace the gasket if needed.</p> <p> CAUTION</p> <p>The gasket is in the outer arm.</p>	<p>Screw: Hex socket head cap screw M4x16 12.9 Lafre 2C2B/FC6.9 (8 pcs)</p> <p>Tightening torque: 2 Nm ±10%</p> <p>For robots with protection class IP30 (option 3350-300)</p>  <p>xx210000933</p>
3	<p>Refit the screws.</p>	<p>For robots with protection class IP54 (option 3350-540)</p> <p>For robots with protection type Clean Room (option 3351-1)</p>  <p>xx2100002427</p>

For Clean Room/ IP54 robots

Refitting the top cover and the flange with bearing



	Action	Note
1	<p>For robots with protection type Clean Room:</p> <p>Clean the joints that have been opened and wipe the parts free from particles with spirit on a lint free. See Cut the paint or surface on the robot before replacing parts on page 118</p> <p> Note</p> <p>After all repair work, wipe the Clean Room robot free from particles with spirit on a lint free cloth.</p>	

Continues on next page

5 Repair

5.6.10 Replacing the transmission module

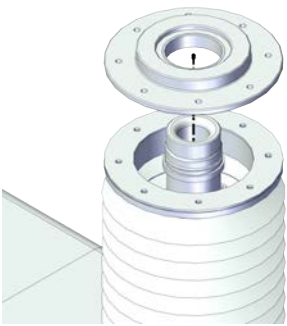
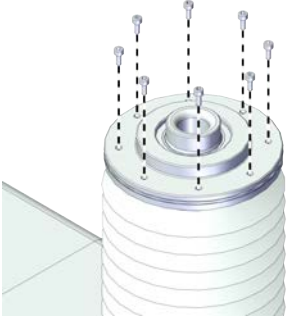
Continued

	Action	Note
2	<p>For robots with protection class IP54 (option 3350-540)</p> <p>For robots with protection type Clean Room (option 3351-1)</p> <p>Install the flange with bearing to the extension shaft.</p>	 <p>xx2100002402</p>
3	<p>For robots with protection class IP54 (option 3350-540)</p> <p>For robots with protection type Clean Room (option 3351-1)</p> <p>Refit the screws to the flange with bearing.</p>	<p>Screws: Hex socket head cap screw M2.5x6 12.9 Lafre 2C2B/FC6.9 (8 pcs)</p> <p>Tightening torque: 0.8 Nm \pm10%</p>  <p>xx2100002401</p>
4	<p>For robots with protection class IP54 (option 3350-540)</p> <p>For robots with protection type Clean Room (option 3351-1)</p> <p>Refit the top cover to the ball screw.</p> <p> Tip</p> <p>The top surface of the cover should be flush with the top end of the ball screw.</p>	 <p>xx2100002399</p>

Continues on next page

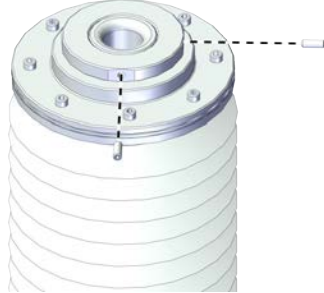
	Action	Note
5	<p>For robots with protection class IP54 (option 3350-540) For robots with protection type Clean Room (option 3351-1) Refit the locking screws.</p>	<p>Screws: Hexagon socket set screws with flat point, ISO 4026 stainless steel M3x8 (2 pcs) Tightening torque: 0.4 Nm ±10%</p>  <p>xx2100002398</p>



Securing the process hub to outer arm cover

	Action	Note
1	<p>For robots with protection type Clean Room: Clean the joints that have been opened and wipe the parts free from particles with spirit on a lint free. See Cut the paint or surface on the robot before replacing parts on page 118</p> <p> Note</p> <p>After all repair work, wipe the Clean Room robot free from particles with spirit on a lint free cloth.</p>	
2	<p>Insert the process hub from the outer arm cover.</p>	

5 Repair

5.6.10 Replacing the transmission module

Continued

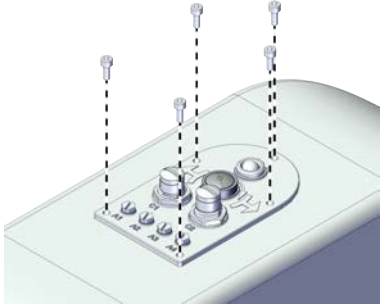
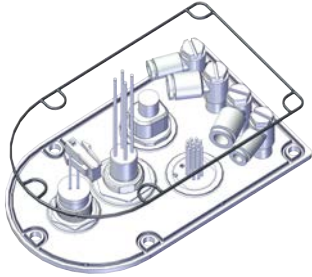
	Action	Note
3	<p>Secure the process hub to the outer arm cover with the screws.</p> <p> Note</p> <p>For robots with protection class IP54 (option 3350-540)</p> <p>For robots with protection type Clean Room (option 3351-1)</p> <p>Check the gasket for the process hub.</p> <p> Tip</p> <p>Replace the gasket if needed.</p> <p> CAUTION</p> <p>Be aware of the cabling that is attached to the cover! The cover can not be removed completely until the connectors are disconnected, as shown in following steps.</p>	<p>Screws: Hex socket head cap screw M4x10 12.9 Lafre 2C2B/FC6.9 (5 pcs)</p> <p>Tightening torque: 2.6 Nm±10%</p> <p>For robots with protection class IP30 (option 3350-300)</p>  <p>xx2100000932</p> <p>For robots with protection class IP54 (option 3350-540)</p> <p>For robots with protection type Clean Room (option 3351-1)</p>  <p>xx2100002438</p>

Concluding procedure

	Action	Note
1	<p>For robots with protection type Clean Room: Seal and paint the joints that have been opened. See Cut the paint or surface on the robot before replacing parts on page 118</p> <p> Note</p> <p>After all repair work, wipe the Clean Room robot free from particles with spirit on a lint free cloth.</p>	
2	Recalibrate the robot.	Calibration is detailed in section Calibration on page 945 .

Continues on next page

	Action	Note
3	 DANGER Make sure all safety requirements are met when performing the first test run.	

5 Repair

5.6.11 Replacing the outer arm

5.6.11 Replacing the outer arm

Location of the outer arm

The outer arm is located as shown in the figure.

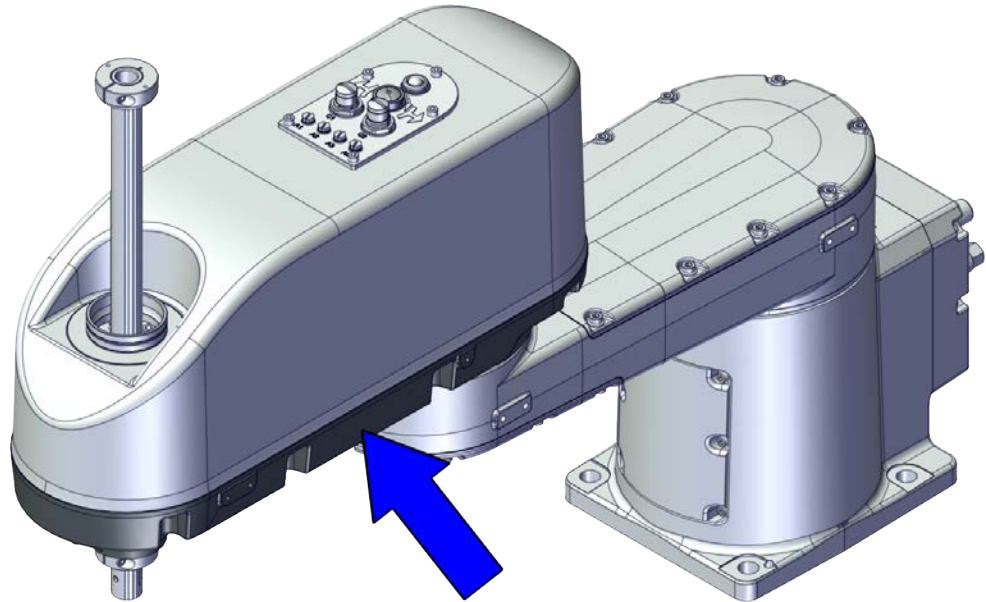

xx2100001013

Required spare parts



Note

The spare part numbers that are listed in the table can be out of date. See the latest spare parts of the IRB 920 via myABB Business Portal, www.abb.com/myABB.

Spare part	Article number	Note
Outer arm	3HAC076575-001	
Outer arm cover	3HAC076611-001	
Outer arm	3HAC081478-001	
Outer arm cover	3HAC081494-001	
Gasket	3HAC073493-001	

Required tools and equipment

Equipment	Article number	Note
Standard toolkit	-	Content is defined in section Standard toolkit on page 996 .

Continues on next page

Equipment	Article number	Note
IRB 920 special tool	3HAC077249-001	Used to install the ball screw nut. Special tool for L2
Calibration toolbox, Axis Calibration	3HAC055412-001	Delivered as a set of calibration tools. Required if Axis Calibration is the valid calibration method for the robot.
24 VDC power supply	-	Used to release the motor brakes.
Sonic tension meter	-	Used for measuring the timing belt tension.
Handheld dynamometer	-	Used for measuring the timing belt tension.

Required consumables

Consumable	Article number	Note
Cable straps	-	
Grease	3HAC029132-001	FM 222

Deciding calibration routine

Decide which calibration routine to be used, based on the information in the table. Depending on which routine is chosen, action might be required prior to beginning the repair work of the robot, see the table.

	Action	Note
1	<p>Decide which calibration routine to use for calibrating the robot.</p> <ul style="list-style-type: none"> Reference calibration. External cable packages (DressPack) and tools can stay fitted on the robot. Fine calibration. All external cable packages (DressPack) and tools must be removed from the robot. 	
	<p>If the robot is to be calibrated with reference calibration:</p> <p>Find previous reference values for the axis or create new reference values. These values are to be used after the repair procedure is completed, for calibration of the robot.</p> <p>If no previous reference values exist, and no new reference values can be created, then reference calibration is not possible.</p>	<p>Follow the instructions given in the reference calibration routine on the FlexPendant to create reference values.</p> <p>Creating new values requires possibility to move the robot.</p> <p>Read more about reference calibration for Axis Calibration in Reference calibration routine on page 957.</p>
	<p>If the robot is to be calibrated with fine calibration:</p> <p>Remove all external cable packages (DressPack) and tools from the robot.</p>	

Continues on next page

5 Repair

5.6.11 Replacing the outer arm



Continued

Removing the outer arm

Use these procedures to remove the outer arm.

Preparations before removing the outer arm



Remove the robot from the wall or enough space.

	Action	Note
1	Decide which calibration routine to use, and take actions accordingly prior to beginning the repair procedure.	
2	<p>If there is no enough space for the maintenance work, remove the robot from the wall and place it on the maintenance bracket.</p> <p> CAUTION</p> <p>Do not lay down the robot during the transportation, always keep it straight. If the robot lay down in any situation, the grease may come out from gearbox.</p>	
3	<p> DANGER</p> <p>Turn off all:</p> <ul style="list-style-type: none"> • electric power supply • hydraulic pressure supply • air pressure supply <p>to the robot, before entering the safeguarded space.</p>	
4	<p> CAUTION</p> <p>For robots with protection type Clean Room Always cut the paint with a knife and grind the paint edge when disassembling parts of the robot! See Cut the paint or surface on the robot before replacing parts on page 118.</p>	

Removing the process hub screws

	Action	Note
1	<p> DANGER</p> <p>Make sure that all supplies for electrical power, hydraulic pressure, and air pressure are turned off.</p>	

Continues on next page

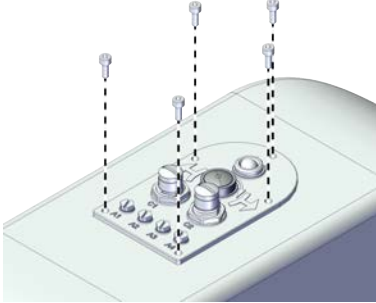
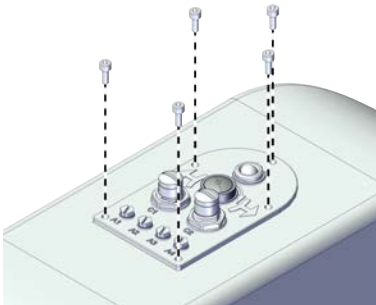
	Action	Note
2	<p> CAUTION</p> <p>For robots with protection type Clean Room Always cut the paint with a knife and grind the paint edge when disassembling parts of the robot! See <i>Cut the paint or surface on the robot before replacing parts on page 118.</i></p>	
3	<p>Remove the screws on the process hub.</p> <p> Note</p> <p>For robots with protection class IP54 (option 3350-540) For robots with protection type Clean Room (option 3351-1) Remove the screws on the process hub and take out the gasket.</p> <p> Tip</p> <p>Check the gasket and replace it if needed.</p>	<p>For robots with protection class IP30</p>  <p>xx2100000932</p> <p>For robots with protection class IP54 (option 3350-540) For robots with protection type Clean Room (option 3351-1)</p>  <p>xx2100000932</p>
4	Insert the process hub to the outer arm.	

For Clean Room/ IP54 robots

Removing the top cover and the flange with bearing



	Action	Note
1	<p> DANGER</p> <p>Make sure that all supplies for electrical power, hydraulic pressure, and air pressure are turned off.</p>	

Continues on next page

5 Repair

5.6.11 Replacing the outer arm

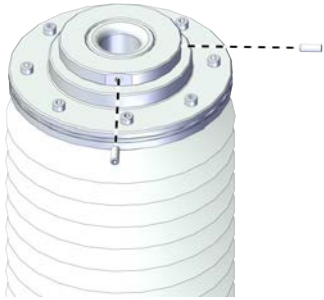

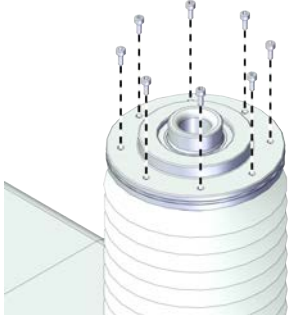
Continued

	Action	Note
2	<p> CAUTION</p> <p>For robots with protection type Clean Room Always cut the paint with a knife and grind the paint edge when disassembling parts of the robot! See Cut the paint or surface on the robot before replacing parts on page 118.</p>	
3	<p>For robots with protection class IP54 (option 3350-540) For robots with protection type Clean Room (option 3351-1) Loose the locking screws.</p>	 <p>xx2100002398</p>
4	<p>For robots with protection class IP54 (option 3350-540) For robots with protection type Clean Room (option 3351-1) Remove the top cover from the ball screw.</p>	 <p>xx2100002399</p>
5	<p>For robots with protection class IP54 (option 3350-540) For robots with protection type Clean Room (option 3351-1) Remove the screws on the flange with bearing.</p>	 <p>xx2100002401</p>

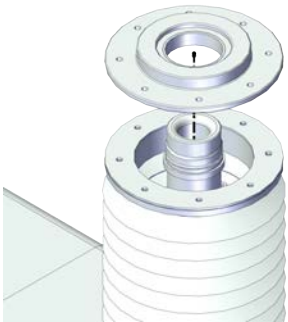
Continues on next page

	Action	Note
6	<p>For robots with protection class IP54 (option 3350-540)</p> <p>For robots with protection type Clean Room (option 3351-1)</p> <p>Remove the flange with bearing.</p>	 <p>xx2100002402</p>



Removing the cover of the outer arm

	Action	Note
1	 <p>DANGER</p> <p>Make sure that all supplies for electrical power, hydraulic pressure, and air pressure are turned off.</p>	
2	 <p>CAUTION</p> <p>For robots with protection type Clean Room</p> <p>Always cut the paint with a knife and grind the paint edge when disassembling parts of the robot! See Cut the paint or surface on the robot before replacing parts on page 118.</p>	

5 Repair

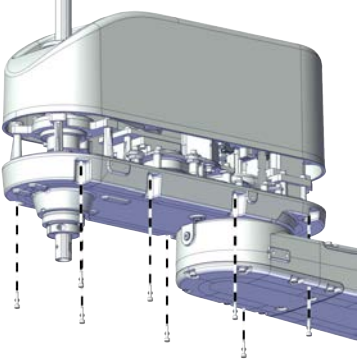
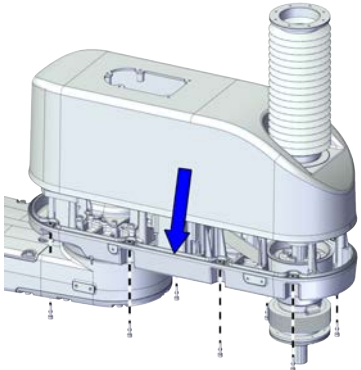

5.6.11 Replacing the outer arm

Continued

	Action	Note
3	<p>Remove the screws on the cover of the outer arm and remove the cover.</p> <p> Note</p> <p>For robots with protection class IP54 (option 3350-540) For robots with protection type Clean Room (option 3351-1) Remove the cover with bellow and housing.</p> <p> Note</p> <p>The bellow does not need to be removed separately.</p> <p> Tip</p> <p>Check the gasket and replace it if needed.</p>	<p>For robots with protection class IP30</p>  <p>xx210000933</p> <p>For robots with protection class IP54 (option 3350-540) For robots with protection type Clean Room (option 3351-1)</p>  <p>xx2100002427</p>

For Clean Room/ IP54 robots

Removing the lower cover and the flange with bearing

	Action	Note
1	<p> DANGER</p> <p>Make sure that all supplies for electrical power, hydraulic pressure, and air pressure are turned off.</p>	
2	<p> CAUTION</p> <p>For robots with protection type Clean Room Always cut the paint with a knife and grind the paint edge when disassembling parts of the robot! See Cut the paint or surface on the robot before replacing parts on page 118.</p>	

Continues on next page

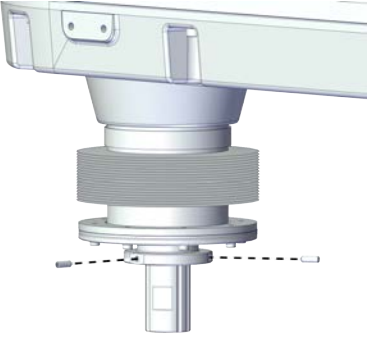
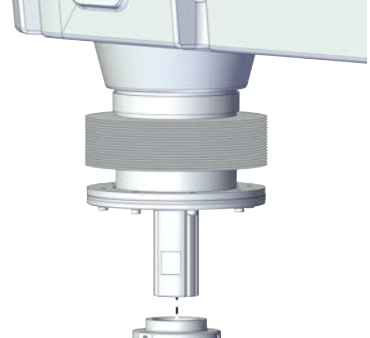
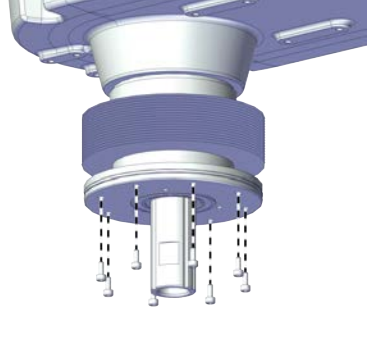
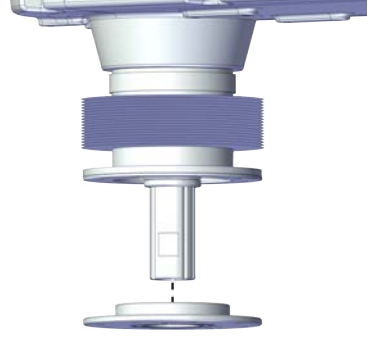
	Action	Note
3	<p>For robots with protection class IP54 (option 3350-540) For robots with protection type Clean Room (option 3351-1) Loose the locking screws.</p>	 <p>xx2100002404</p>
4	<p>For robots with protection class IP54 (option 3350-540) For robots with protection type Clean Room (option 3351-1) Remove the lower cover from the ball screw.</p>	 <p>xx2100002405</p>
5	<p>For robots with protection class IP54 (option 3350-540) For robots with protection type Clean Room (option 3351-1) Remove the screws on the flange with bearing.</p>	 <p>xx2100002406</p>
6	<p>For robots with protection class IP54 (option 3350-540) For robots with protection type Clean Room (option 3351-1) Remove the flange with bearing.</p>	 <p>xx2100002407</p>







Continues on next page

5 Repair

5.6.11 Replacing the outer arm

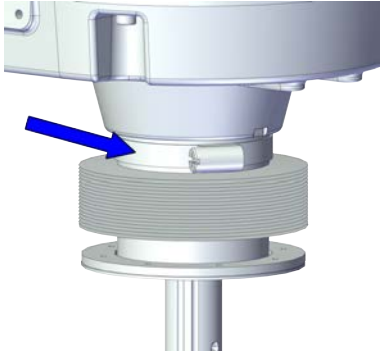



Continued

Removing the lower bellow

	Action	Note
1	 DANGER Make sure that all supplies for electrical power, hydraulic pressure, and air pressure are turned off.	
2	 CAUTION For robots with protection type Clean Room Always cut the paint with a knife and grind the paint edge when disassembling parts of the robot! See Cut the paint or surface on the robot before replacing parts on page 118 .	
3	For robots with protection class IP54 (option 3350-540) For robots with protection type Clean Room (option 3351-1) Loosen the upper bellow clamp by loosening the screw and pull the clamp apart slightly.	 <p>xx2100002408</p>
4	For robots with protection class IP54 (option 3350-540) For robots with protection type Clean Room (option 3351-1) Remove the bellow from the outer arm.  Note For robots with protection class IP54 (option 3350-540) Clean the bellow from the glue if it will be reused.	
5	For robots with protection class IP54 (option 3350-540) Remove the bellow gasket from the bellow.  Note Clean the bellow gasket from the glue if it will be reused.  Note Be careful when removing the bellow gaskets. If any broken, replace it.	

Continues on next page

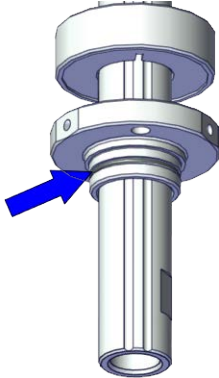
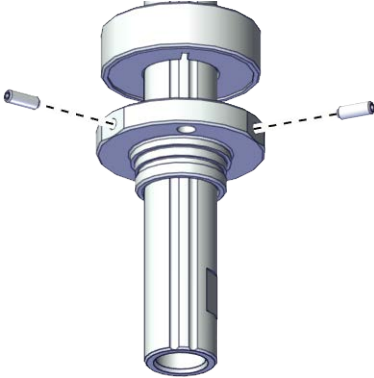
Removing the shaft for Clean Room/ IP54 robots

	Action	Note
1	 <p>DANGER</p> <p>Make sure that all supplies for electrical power, hydraulic pressure, and air pressure are turned off.</p>	
2	 <p>CAUTION</p> <p>For robots with protection type Clean Room Always cut the paint with a knife and grind the paint edge when disassembling parts of the robot! See <i>Cut the paint or surface on the robot before replacing parts on page 118.</i></p>	
3	<p>For robots with protection class IP54 (option 3350-540) For robots with protection type Clean Room (option 3351-1) Remove the O-ring from the lower housing.</p>	 <p>xx1900001615</p>
4	<p>For robots with protection class IP54 (option 3350-540) For robots with protection type Clean Room (option 3351-1) Loose the attachment screws.</p>	 <p>xx1900001616</p>
5	<p>For robots with protection class IP54 (option 3350-540) For robots with protection type Clean Room (option 3351-1) Remove the shaft from the mechanical stopper.</p>  <p>Note</p> <p>The shaft is glued to the ball screw. Be careful with the glue when removing the shaft.</p>	<p>xx1900001616</p>



Continues on next page

5 Repair





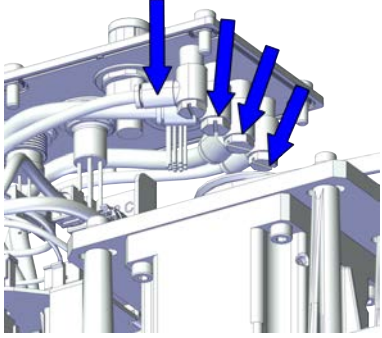

5.6.11 Replacing the outer arm

Continued

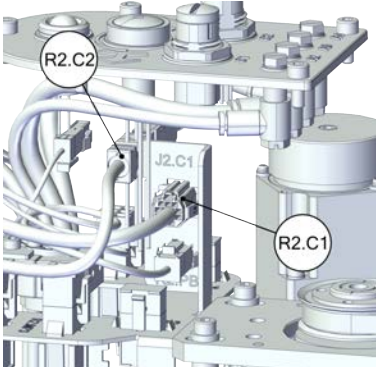
Disconnecting the air hoses, C1 cabling and C2 cabling (if equipped)

	Action	Note
1	 DANGER Make sure that all supplies for electrical power, hydraulic pressure, and air pressure are turned off.	
2	 CAUTION For robots with protection type Clean Room Always cut the paint with a knife and grind the paint edge when disassembling parts of the robot! See <i>Cut the paint or surface on the robot before replacing parts on page 118.</i>	
3	Disconnect the air hoses from the L-shaped connectors.	 xx2100001032

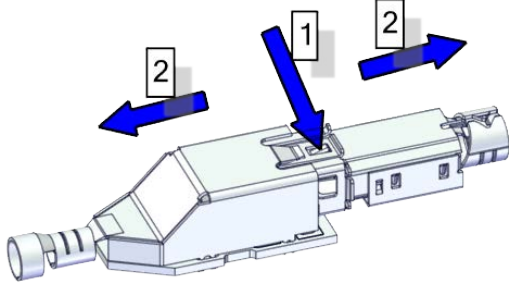
Continues on next page

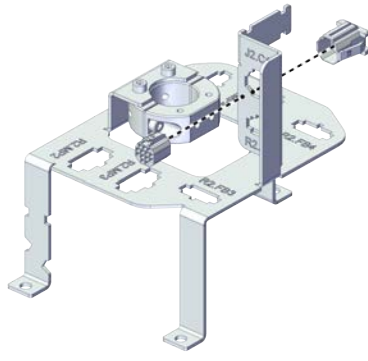
	Action	Note
4	<p>For robots with C1 cabling Disconnect the connector.</p> <ul style="list-style-type: none"> • R2.C1 	
5	<p>For robots with C2 cabling Disconnect the connector.</p> <ul style="list-style-type: none"> • R1.C2 <p> Tip</p> <p>Cut the cable straps for the R1.C2 at the same time.</p> <p> Tip</p> <p>Take photos of the connector and cable position before disconnecting them, to have as a reference when reconnecting.</p> <p> Tip</p> <p>The connector clip has to be pressed (1) and pushed forward (2) to separate the R1.C2 (for C2 cabling).</p> 	<p>xx2100001033</p>
6	<p>Snap loose and remove the female head of the connectors from the bracket.</p> <p> Note</p> <p>The harness are not visible due to the cleanliness requirements of the illustration. They are still existing inside the cable ferrule in the actual situation.</p>	 <p>xx2100001034</p>





Continues on next page

5 Repair

5.6.11 Replacing the outer arm

Continued

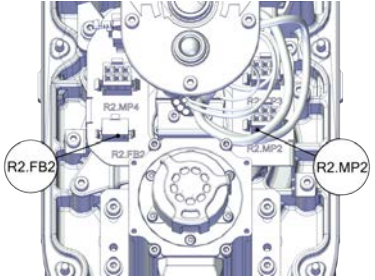

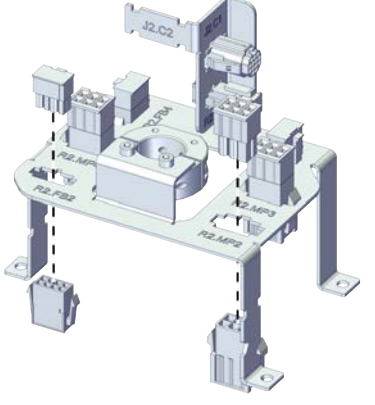
Disconnecting the connectors for axis-2 motor

	Action	Note
1	 DANGER Make sure that all supplies for electrical power, hydraulic pressure, and air pressure are turned off.	
2	 CAUTION For robots with protection type Clean Room Always cut the paint with a knife and grind the paint edge when disassembling parts of the robot! See Cut the paint or surface on the robot before replacing parts on page 118 .	
3	Disconnect the connectors. <ul style="list-style-type: none"> • R2.MP2 • R2.FB2 	 xx210000934
4	Snap loose and remove the female head of the connectors from the bracket.  Note The harness are not visible due to the cleanliness requirements of the illustration. They are still existing inside the cable ferrule in the actual situation.	 xx210000935

Disconnecting the connectors for axis-3 motor

	Action	Note
1	 DANGER Make sure that all supplies for electrical power, hydraulic pressure, and air pressure are turned off.	

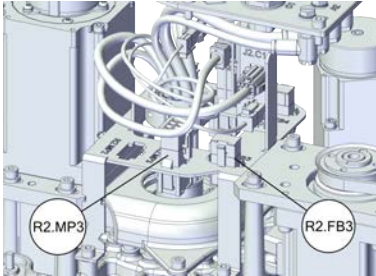
Continues on next page

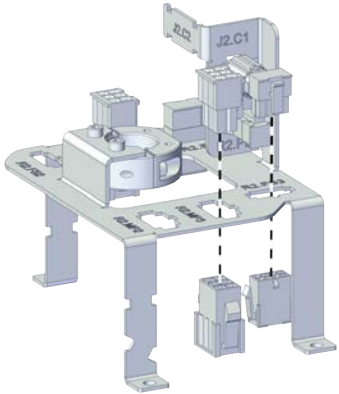
	Action	Note
2	<p> CAUTION</p> <p>For robots with protection type Clean Room Always cut the paint with a knife and grind the paint edge when disassembling parts of the robot! See Cut the paint or surface on the robot before replacing parts on page 118.</p>	
3	<p>Disconnect the connectors.</p> <ul style="list-style-type: none"> • R2.MP3 • R2.FB3 	 <p>xx2100000936</p>
4	<p>Snap loose and remove the female head of the connectors from the bracket.</p> <p> Note</p> <p>The harness are not visible due to the cleanness requirements of the illustration. They are still existing inside the cable ferrule in the actual situation.</p>	 <p>xx2100000937</p>



Disconnecting the connectors for axis-4 motor

	Action	Note
1	<p>For robots with protection type Clean Room: Clean the joints that have been opened and wipe the parts free from particles with spirit on a lint free. See Cut the paint or surface on the robot before replacing parts on page 118</p> <p> Note</p> <p>After all repair work, wipe the Clean Room robot free from particles with spirit on a lint free cloth.</p>	

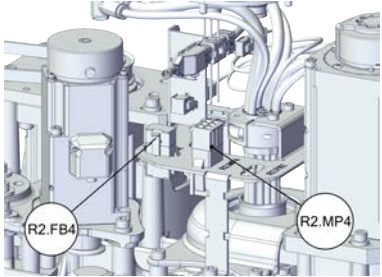

5 Repair

5.6.11 Replacing the outer arm

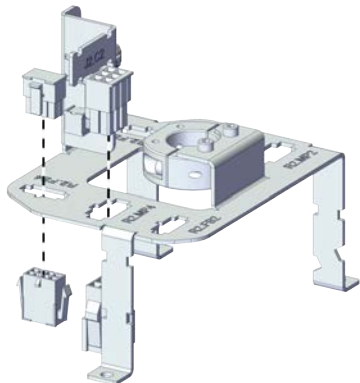

Continued

	Action	Note
2	Disconnect the axis-4 motor connectors. <ul style="list-style-type: none"> • R2.MP4 • R2.FB4 	 <p>xx2100000938</p>
3	Snap loose and remove the female head of the connectors from the bracket.  Note The harness are not visible due to the cleanness requirements of the illustration. They are still existing inside the cable ferrule in the actual situation.	 <p>xx2100000939</p>

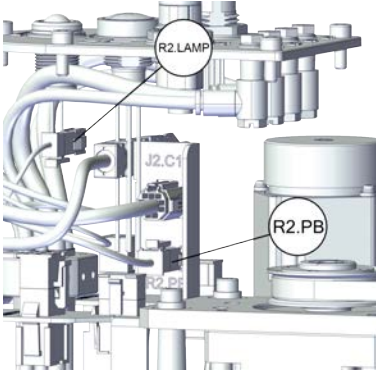

Disconnecting the connector for PB

	Action	Note
1	 DANGER Make sure that all supplies for electrical power, hydraulic pressure, and air pressure are turned off.	
2	 CAUTION For robots with protection type Clean Room Always cut the paint with a knife and grind the paint edge when disassembling parts of the robot! See Cut the paint or surface on the robot before replacing parts on page 118 .	

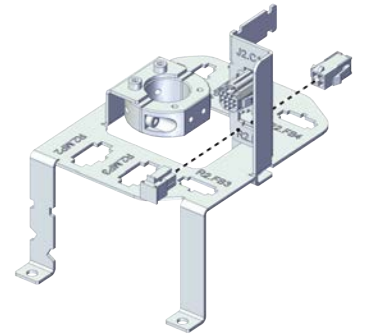
Continues on next page

	Action	Note
3	Disconnect the connector. <ul style="list-style-type: none"> • R2.PB • R2.LAMP 	 <p>xx2100001030</p>
4	Snap loose and remove the female head of the connector from the bracket.  Note The harness are not visible due to the cleanness requirements of the illustration. They are still existing inside the cable ferrule in the actual situation.	 <p>xx2100001031</p>

Pull out the process hub



	Action	Note
1	 DANGER Make sure that all supplies for electrical power, hydraulic pressure, and air pressure are turned off.	
2	 CAUTION For robots with protection type Clean Room Always cut the paint with a knife and grind the paint edge when disassembling parts of the robot! See Cut the paint or surface on the robot before replacing parts on page 118.	

Continues on next page



5 Repair

5.6.11 Replacing the outer arm

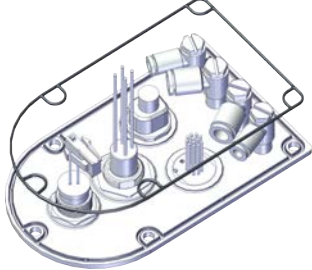
Continued

	Action	Note
3	<p>Take out the process hub.</p> <p> Note</p> <p>For robots with protection class IP54 (option 3350-540)</p> <p>For robots with protection type Clean Room (option 3351-1)</p> <p>Check the gasket for the process hub.</p> <p> Tip</p> <p>Replace the gasket if needed.</p> <p> CAUTION</p> <p>Be aware of the cabling that is attached to the cover! The cover can not be removed completely until the connectors are disconnected, as shown in following steps.</p>	<p>For robots with protection class IP54 (option 3350-540)</p> <p>For robots with protection type Clean Room (option 3351-1)</p>  <p>xx2100002438</p>

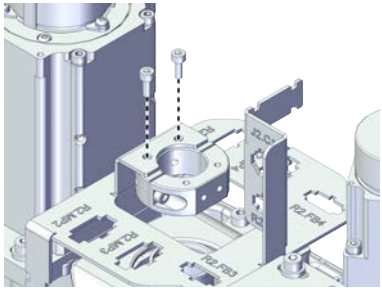

Removing the cable ferrule and bracket

	Action	Note
1	<p> DANGER</p> <p>Make sure that all supplies for electrical power, hydraulic pressure, and air pressure are turned off.</p>	
2	<p> CAUTION</p> <p>For robots with protection type Clean Room</p> <p>Always cut the paint with a knife and grind the paint edge when disassembling parts of the robot! See Cut the paint or surface on the robot before replacing parts on page 118.</p>	
3	<p>Remove the screws on the bracket to the cable ferrule to release the cable ferrule with cable.</p> <p> Note</p> <p>The harness are not visible due to the cleanness requirements of the illustration. They are still existing inside the cable ferrule in the actual situation.</p>	 <p>xx2100000940</p>

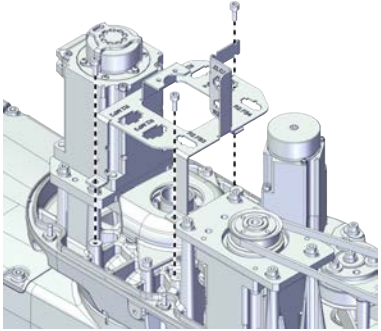
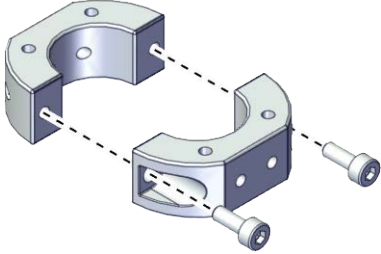
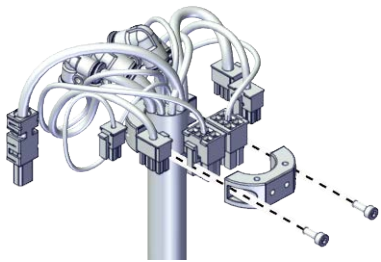
Continues on next page

	Action	Note
4	<p>Remove the screws on the bracket.</p> <p> Note</p> <p>The harness are not visible due to the cleanness requirements of the illustration. They are still existing inside the cable ferrule in the actual situation.</p>	 <p>xx210000941</p>
5	<p>Remove the screws on the cable ferrule and take the cable ferrule out.</p>	 <p>xx1800002842</p>  <p>xx1800002849</p>

Removing the gear-2 pulley protection cover

	Action	Note
1	<p> DANGER</p> <p>Make sure that all supplies for electrical power, hydraulic pressure, and air pressure are turned off.</p>	
2	<p> CAUTION</p> <p>For robots with protection type Clean Room Always cut the paint with a knife and grind the paint edge when disassembling parts of the robot! See Cut the paint or surface on the robot before replacing parts on page 118.</p>	

Continues on next page



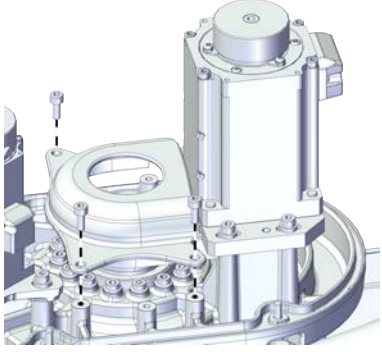

5 Repair

5.6.11 Replacing the outer arm

Continued

	Action	Note
3	Remove the screws on the pulley protection cover to release the pulley protection cover.	 <p>xx2100001047</p>

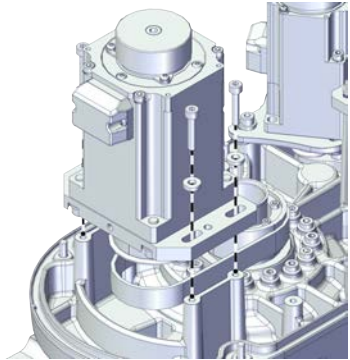
Removing the axis-2 motor sub-assembly

	Action	Note
1	 DANGER Make sure that all supplies for electrical power, hydraulic pressure, and air pressure are turned off.	
2	 CAUTION For robots with protection type Clean Room Always cut the paint with a knife and grind the paint edge when disassembling parts of the robot! See Cut the paint or surface on the robot before replacing parts on page 118 .	
3	Remove the screws and washers.	 <p>xx2100001046</p>
4	Remove the motor.  Tip Move the internal harness out of the way.	



Removing the axis-2 timing belt

	Action	Note
1	 DANGER Make sure that all supplies for electrical power, hydraulic pressure, and air pressure are turned off.	

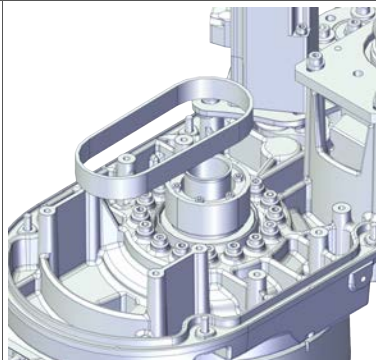
Continues on next page

	Action	Note
2	 CAUTION For robots with protection type Clean Room Always cut the paint with a knife and grind the paint edge when disassembling parts of the robot! See <i>Cut the paint or surface on the robot before replacing parts on page 118.</i>	
3	Remove the timing belt from the outer arm.	 xx2100001048

Removing the axis-3 motor sub-assembly

	Action	Note
1	 DANGER Make sure that all supplies for electrical power, hydraulic pressure, and air pressure are turned off.	
2	 CAUTION For robots with protection type Clean Room Always cut the paint with a knife and grind the paint edge when disassembling parts of the robot! See <i>Cut the paint or surface on the robot before replacing parts on page 118.</i>	
3	 DANGER Make sure that the ball screw is supported with something. The sudden drop of the ball screw due the lost of the axis-3 motor may cause danger.	

Continues on next page



5 Repair

5.6.11 Replacing the outer arm

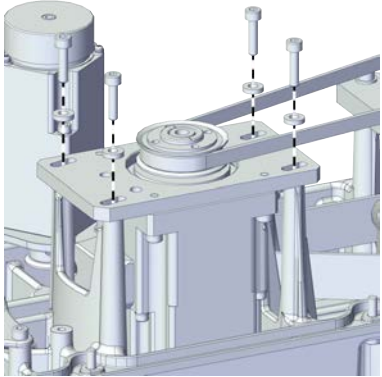
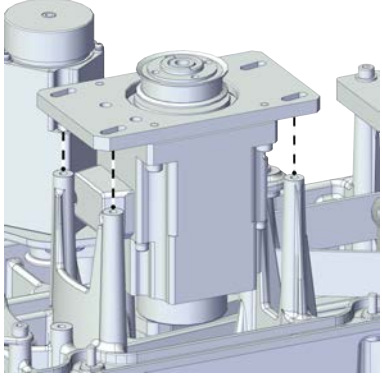

Continued

	Action	Note
4	Remove the screws.	 <p>xx2100001178</p>
5	Remove the axis-3 motor sub-assembly and the timing belt.	 <p>xx2100001181</p>

Removing the lower mechanical stopper

	Action	Note
1	 DANGER Make sure that all supplies for electrical power, hydraulic pressure, and air pressure are turned off.	
2	 CAUTION For robots with protection type Clean Room Always cut the paint with a knife and grind the paint edge when disassembling parts of the robot! See Cut the paint or surface on the robot before replacing parts on page 118 .	

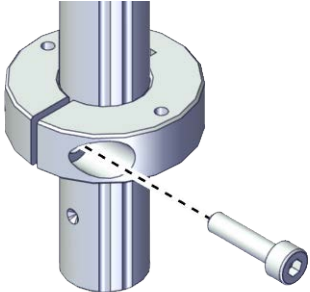
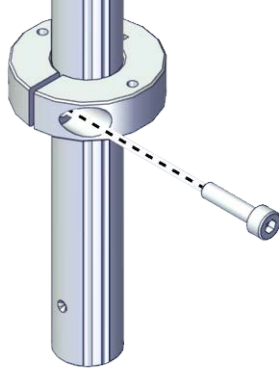
Continues on next page

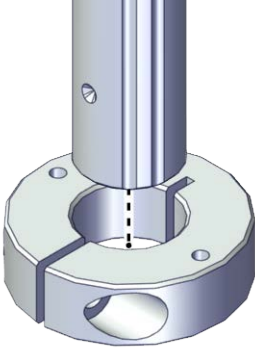
	Action	Note
3	Remove the screw.	<p>For robots with protection class IP30 (option 3350-300)</p>  <p>xx1800002860</p> <p>For robots with protection class IP54 (option 3350-540) For robots with protection type Clean Room (option 3351-1)</p>  <p>xx1900001642</p>
4	<p>Remove the mechanical stopper.</p> <p> CAUTION</p> <p>If the ball screw nut or ball screw spline nut go out of the screw shaft, the ball screw is destroyed. Be careful when you do any work that may cause this.</p>	 <p>xx1800002861</p>

Removing the ball screw with the flange



	Action	Note
1	<p> DANGER</p> <p>Make sure that all supplies for electrical power, hydraulic pressure, and air pressure are turned off.</p>	

Continues on next page



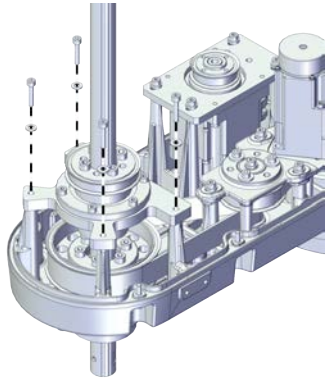
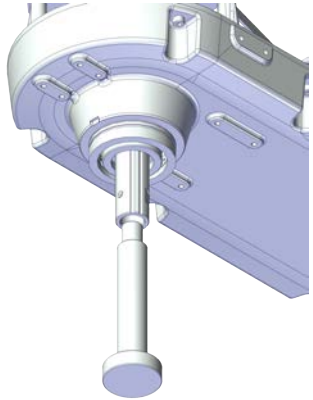

5 Repair

5.6.11 Replacing the outer arm

Continued

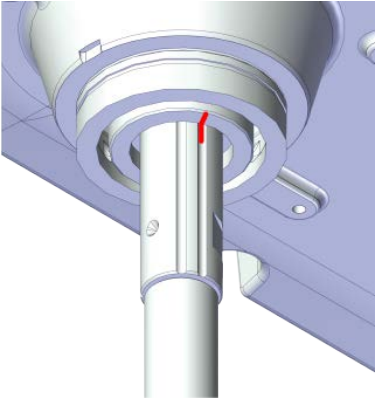
	Action	Note
2	 ELECTROSTATIC DISCHARGE (ESD) The unit is sensitive to ESD. Before handling the unit read the safety information in section The unit is sensitive to ESD on page 49 .	
3	 CAUTION For robots with protection type Clean Room Always cut the paint with a knife and grind the paint edge when disassembling parts of the robot! See Cut the paint or surface on the robot before replacing parts on page 118 .	
4	Remove the screws and washers on the ball screw flange.	 xx2100001082
5	Insert the special tool into the ball screw shaft.	IRB 920 special tool:3HAC077249-001  xx2100001129

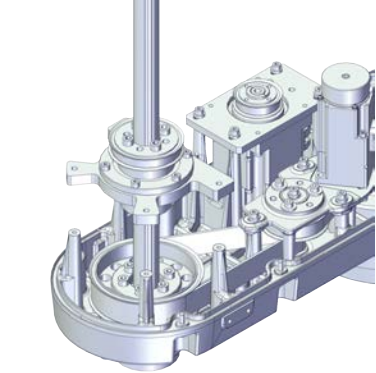
Continues on next page

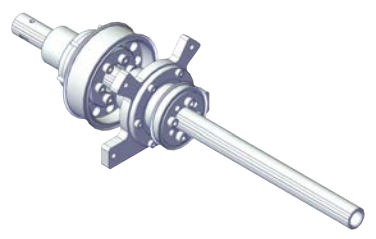
	Action	Note
6	Mark the location of the ball screw shaft grooves on the ball screw lower nut.	 <p>xx2100001187</p>
7	Take out the ball screw with the flange assembly carefully.  CAUTION Move the special tool along with the ball screw shaft until it is totally inserted into the lower nut of the ball screw and keep the status. When the special tool is totally inserted to the lower nut of the ball screw, support the special tool with some thing. Or the ball screw lower nut will be destroyed.	 <p>xx2100001083</p>
8	Lay down the ball screw assembly.  CAUTION If the ball screw nut or ball screw spline nut go out of the screw shaft, the ball screw is destroyed. Be careful when you do any work that may cause this.	 <p>xx2100001084</p>

Removing the transmission module assembly

	Action	Note
1	 DANGER Make sure that all supplies for electrical power, hydraulic pressure, and air pressure are turned off.	

Continues on next page



5 Repair

5.6.11 Replacing the outer arm

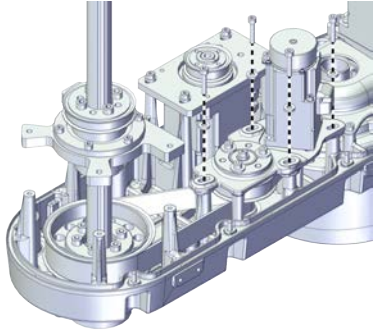

Continued

	Action	Note
2	 CAUTION For robots with protection type Clean Room Always cut the paint with a knife and grind the paint edge when disassembling parts of the robot! See Cut the paint or surface on the robot before replacing parts on page 118 .	
3	Removing the screws of the transmission module assembly.	 xx2100001091
4	Take out the transmission module assembly with the axis-4-2 timing belt.	

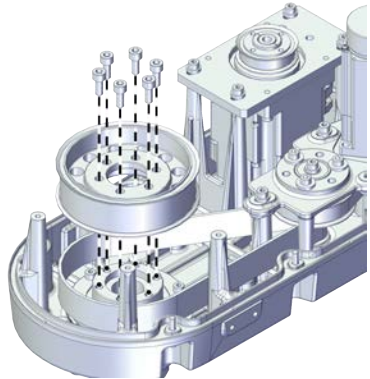

Removing the pulley on the ball screw lower position

	Action	Note
1	 DANGER Make sure that all supplies for electrical power, hydraulic pressure, and air pressure are turned off.	
2	 ELECTROSTATIC DISCHARGE (ESD) The unit is sensitive to ESD. Before handling the unit read the safety information in section The unit is sensitive to ESD on page 49 .	
3	 CAUTION For robots with protection type Clean Room Always cut the paint with a knife and grind the paint edge when disassembling parts of the robot! See Cut the paint or surface on the robot before replacing parts on page 118 .	

Continues on next page

	Action	Note
4	Remove the screws and washers.	 <p>xx2100001085</p>
5	Remove the pulley carefully.  CAUTION If the ball screw nut or ball screw spline nut go out of the screw shaft, the ball screw is destroyed. Be careful when you do any work that may cause this.	



Removing the ball screw lower nut

	Action	Note
1	 DANGER Make sure that all supplies for electrical power, hydraulic pressure, and air pressure are turned off.	
2	 CAUTION For robots with protection type Clean Room Always cut the paint with a knife and grind the paint edge when disassembling parts of the robot! See Cut the paint or surface on the robot before replacing parts on page 118 .	

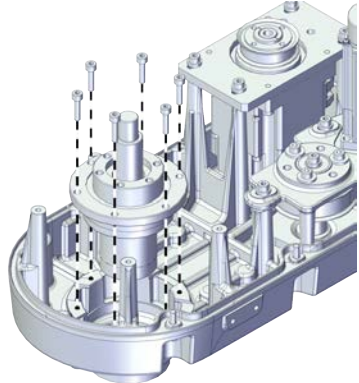

5 Repair

5.6.11 Replacing the outer arm

Continued

	Action	Note
3	<p>Remove the screws on the lower nut to the outer arm.</p> <p> Tip</p> <p>Hold the ball screw to prevent it from dropping. Or the ball screw may be destroyed.</p>	<p>IRB 920 special tool:3HAC077249-001</p>  <p>xx2100001088</p>
4	<p>Raise the ball screw lower nut with the special tool to take them out of the outer arm carefully.</p> <p> Tip</p> <p>Hold the lower part of the ball screw to prevent it from dropping. Or the ball screw may be destroyed.</p> <p> CAUTION</p> <p>If the ball screw nut or ball screw spline nut go out of the screw shaft, the ball screw is destroyed. Be careful when you do any work that may cause this.</p>	

Removing the outer arm

	Action	Note
1	<p> DANGER</p> <p>Make sure that all supplies for electrical power, hydraulic pressure, and air pressure are turned off.</p>	
2	<p> CAUTION</p> <p>For robots with protection type Clean Room Always cut the paint with a knife and grind the paint edge when disassembling parts of the robot! See Cut the paint or surface on the robot before replacing parts on page 118.</p>	

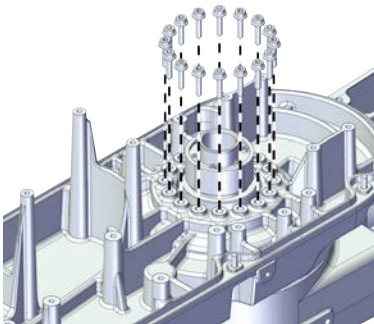
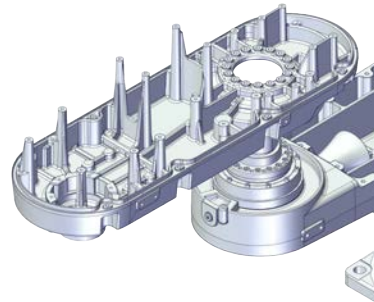

Continues on next page

	Action	Note
3	Remove the screws on the axis -2 gear inside the outer arm.	 <p>xx2100001098</p>
4	Remove the outer arm slightly.	 <p>xx2100001099</p>

Refitting the outer arm

Use these procedures to refit the outer arm.

Refitting the outer arm

	Action	Note
1	 <p>DANGER</p> <p>Make sure that all supplies for electrical power, hydraulic pressure, and air pressure are turned off.</p>	
2	 <p>CAUTION</p> <p>For robots with protection type Clean Room Always cut the paint with a knife and grind the paint edge when disassembling parts of the robot! See Cut the paint or surface on the robot before replacing parts on page 118.</p>	
3	Insert the main harness through the outer arm.	

Continues on next page



5 Repair

5.6.11 Replacing the outer arm

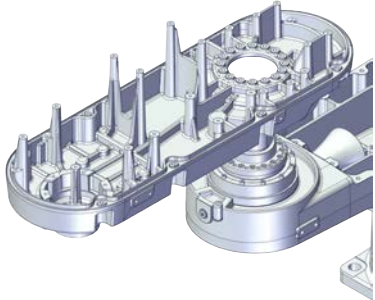
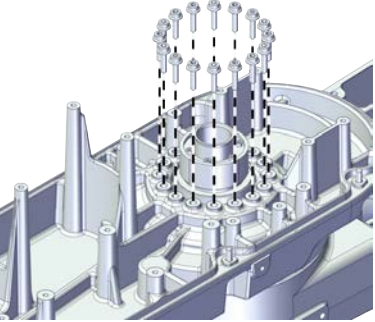
Continued

	Action	Note
4	<p>Refit the outer arm to the axis-2 gear unit on the inner arm.</p> <p> Tip</p> <p>When the gear unit is in the right position, you can hear a clear "Click".</p>	 <p>xx2100001099</p>
5	<p>Refit the screws.</p>	<p>Screws: Hex socket head cap screw M4x12 12.9 Lafre 2C2B/FC6.9 (16 pcs)</p> <p>Washers: Spring washer 9x4.3x1 Steel (16 pcs)</p> <p>Tightening torque: 3.5 Nm ±10%</p>  <p>xx2100001098</p>

Refitting the ball screw lower nut



	Action	Note
1	<p> DANGER</p> <p>Make sure that all supplies for electrical power, hydraulic pressure, and air pressure are turned off.</p>	
2	<p> CAUTION</p> <p>For robots with protection type Clean Room</p> <p>Always cut the paint with a knife and grind the paint edge when disassembling parts of the robot!</p> <p>See Cut the paint or surface on the robot before replacing parts on page 118.</p>	

Continues on next page

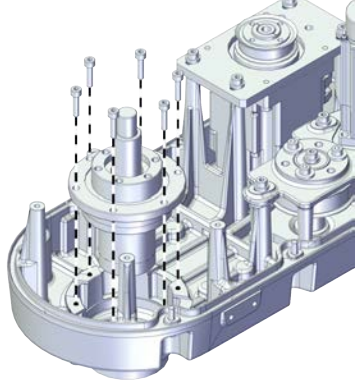
5.6.11 Replacing the outer arm
Continued

	Action	Note
3	Put the ball screw lower nut to the outer arm carefully.  CAUTION Make sure the ball screw nut works fluently.	Screws: Hex socket head cap screw M4x16 12.9 Lafre 2C2B/FC6.9 (6 pcs) Tightening torque: 3.5 Nm ±10%  xx2100001088
4	Secure the screws on the lower nut to the outer arm.	

Refitting the pulley on the ball screw lower position



	Action	Note
1	 ELECTROSTATIC DISCHARGE (ESD) The unit is sensitive to ESD. Before handling the unit read the safety information in section The unit is sensitive to ESD on page 49 .	
2	For robots with protection type Clean Room: Clean the joints that have been opened and wipe the parts free from particles with spirit on a lint free. See Cut the paint or surface on the robot before replacing parts on page 118  Note After all repair work, wipe the Clean Room robot free from particles with spirit on a lint free cloth.	

Continues on next page

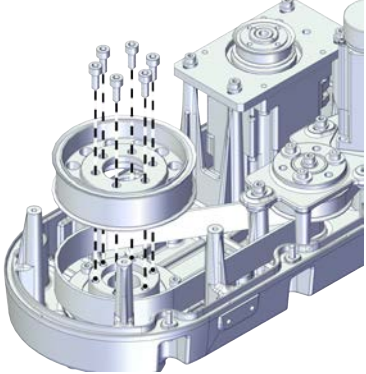

5 Repair

5.6.11 Replacing the outer arm

Continued

	Action	Note
3	<p>Refit the pulley to the ball screw carefully.</p> <p> CAUTION</p> <p>If the ball screw nut or ball screw spline nut go out of the screw shaft, the ball screw is destroyed. Be careful when you do any work that may cause this.</p>	<p>Screws: Hex socket head cap screw M5x12 12.9 Lafre 2C2B/FC6.9 (6 pcs)</p> <p>Washers: Spring washer 9x4.3x1 Steel (6 pcs)</p> <p>Tightening torque: 4.4 Nm \pm10%</p>  <p>xx2100001085</p>
4	<p>Refit the screws.</p> <p> Tip</p> <p>Secure with the stopping tool to prevent the pulley from rotating.</p>	

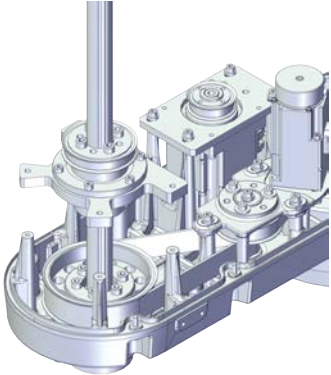
Refitting the ball screw with the flange

	Action	Note
1	<p>For robots with protection type Clean Room: Clean the joints that have been opened and wipe the parts free from particles with spirit on a lint free. See Cut the paint or surface on the robot before replacing parts on page 118</p> <p> Note</p> <p>After all repair work, wipe the Clean Room robot free from particles with spirit on a lint free cloth.</p>	<p>IRB 920 special tool:3HAC077249-001</p>  <p>xx2100001083</p>
2	<p>Refit the ball screw assembly to the outer arm.</p> <p> Tip</p> <p>Make sure the marked location is aligned with the ball screw shaft grooves.</p> <p> CAUTION</p> <p>With the inserting of the ball screw shaft, remove the special tool along with the ball screw shaft carefully.</p>	

Continues on next page

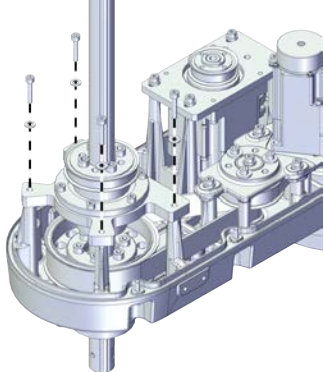
	Action	Note
3	<p>Refit the screws and washers to secure the ball screw flange to the outer arm.</p> <p> Tip</p> <p>Pre-tighten the screws at 0.5Nm and slide the ball screw up and down for five times. Then tighten the screws at 3.8Nm to secure it.</p>	<p>Screws: Hex socket head cap screw M4x20 12.9 Lafre 2C2B/FC6.9 (4 pcs)</p> <p>Washers: Spring washer 9x4.3x1 Steel (4 pcs)</p> <p>Tightening torque: 3.5 Nm \pm10%</p>  <p>xx2100001082</p>

Refitting the mechanical stopper





	Action	Note
1	<p>For robots with protection type Clean Room: Clean the joints that have been opened and wipe the parts free from particles with spirit on a lint free. See Cut the paint or surface on the robot before replacing parts on page 118</p> <p> Note</p> <p>After all repair work, wipe the Clean Room robot free from particles with spirit on a lint free cloth.</p>	

Continues on next page

5 Repair

5.6.11 Replacing the outer arm

Continued

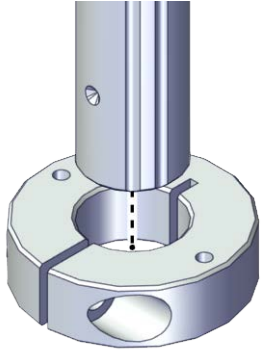
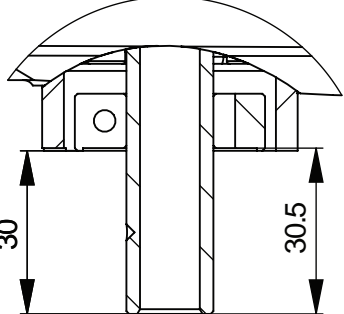
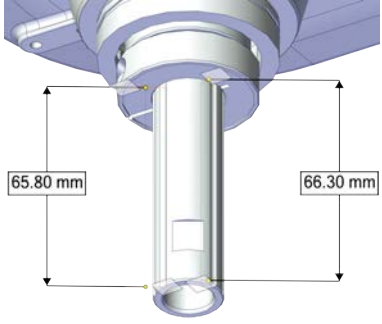
	Action	Note
2	<p>Refit the mechanical stopper to the ball screw at 30.5 mm position to the lower of the ball screw.</p> <p> Note</p> <p>For robots with protection class IP54 (option 3350-540) For robots with protection type Clean Room (option 3351-1) For 180 mm ball screw, refit the mechanical stopper to the ball screw at 65.8 mm position to the lower of the ball screw. For 300 mm ball screw, refit the mechanical stopper to the ball screw at 80.8 mm position to the lower of the ball screw.</p> <p> Tip</p> <p>Make sure that the limit block opening gap is aligned with the ball screw origin point.</p> <p> CAUTION</p> <p>If the ball screw nut or ball screw spline nut go out of the screw shaft, the ball screw is destroyed. Be careful when you do any work that may cause this.</p> <p> Note</p> <p>Be careful with the orientation of the mechanical stopper. The flat side is on the upper side.</p>	 <p>xx1800002861</p> <p>For robots with protection class IP30 (option 3350-300)</p>  <p>xx1900000144</p> <p>For robots with protection class IP54 (option 3350-540) For robots with protection type Clean Room (option 3351-1) For 180 mm ball screw</p>  <p>xx2100002425</p> <p>For 300 mm ball screw</p>

Continues on next page

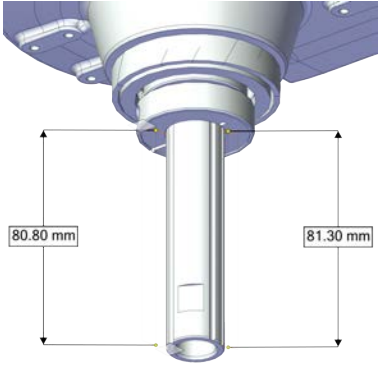
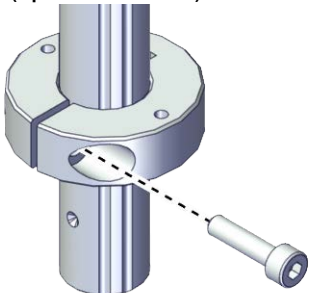
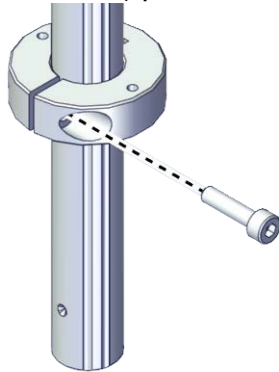
	Action	Note
		 <p>xx2100002426</p>
3	Refit the screw.	<p>Screws: Hex socket head cap screw M4x16 12.9 Lafre 2C2B/FC6.9 (1 pcs) Tightening torque: 6.5 Nm For robots with protection class IP30 (option 3350-300)</p>  <p>xx1800002860</p> <p>For robots with protection class IP54 (option 3350-540) For robots with protection type Clean Room (option 3351-1)</p>  <p>xx1900001642</p>



Continues on next page

5 Repair

5.6.11 Replacing the outer arm

Continued

Refitting the transmission module assembly to the outer arm

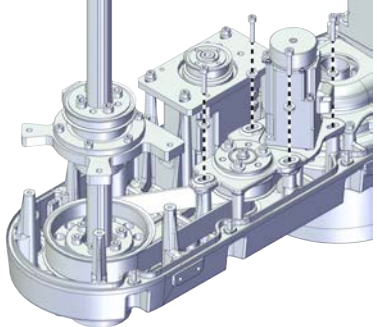
	Action	Note
1	<p>For robots with protection type Clean Room: Clean the joints that have been opened and wipe the parts free from particles with spirit on a lint free. See Cut the paint or surface on the robot before replacing parts on page 118</p> <p> Note</p> <p>After all repair work, wipe the Clean Room robot free from particles with spirit on a lint free cloth.</p>	
2	<p>Refit the transmission module assembly to the outer arm.</p> <p> Tip</p> <p>Place the axis-4 second timing belt through the ball screw flange.</p>	<p>Screws: Hex socket head cap screw M4x20 12.9 Lafre 2C2B/FC6.9 (4 pcs)</p> <p>Washers: Plain washer machining 4.2x9x2 steel (4 pcs)</p> <p>Tightening torque: 2.6 Nm \pm10%</p>
3	Secure with the screws without fully tightened.	 <p>xx2100001091</p>



Refitting the axis-4 second timing belt to the pulley

	Action	Note
1	<p>For robots with protection type Clean Room: Clean the joints that have been opened and wipe the parts free from particles with spirit on a lint free. See Cut the paint or surface on the robot before replacing parts on page 118</p> <p> Note</p> <p>After all repair work, wipe the Clean Room robot free from particles with spirit on a lint free cloth.</p>	

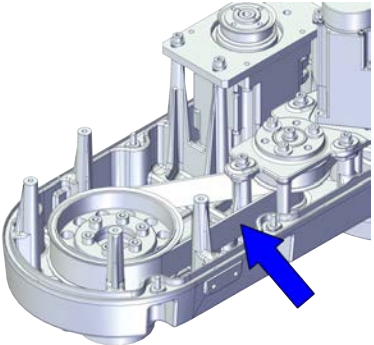
Continues on next page

	Action	Note
2	Refit the belt to the pulley. Ensure that the belt runs correctly in the grooves.	Timing belt, A4-2: 3HAC070471-001  xx2100001086

Fastening the ball screw flange

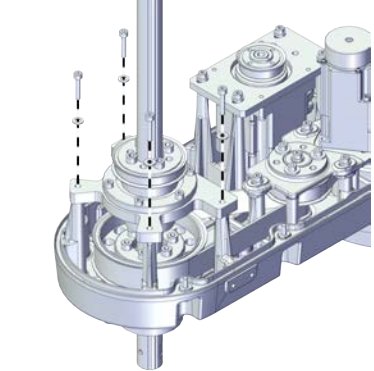
	Action	Note
1	 DANGER Make sure that all supplies for electrical power, hydraulic pressure, and air pressure are turned off.	
2	 CAUTION For robots with protection type Clean Room Always cut the paint with a knife and grind the paint edge when disassembling parts of the robot! See Cut the paint or surface on the robot before replacing parts on page 118 .	
3	 DANGER Make sure that the ball screw is supported with something. The sudden drop of the ball screw due the lost of the axis-3 motor may cause danger.	
4	Tighten the screws of the ball screw flange.	 xx2100001082





Continues on next page

5 Repair

5.6.11 Replacing the outer arm

Continued

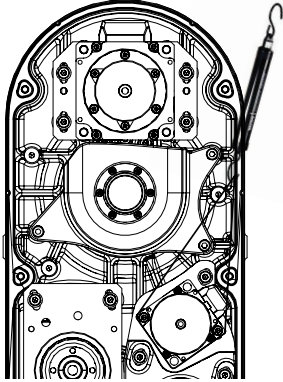
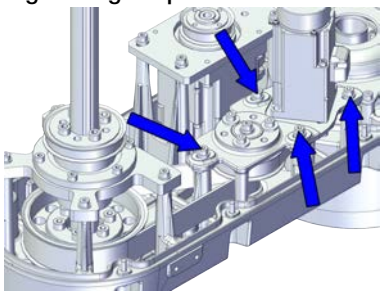

Adjusting the axis-4 second timing belt tension

	Action	Note
1	 DANGER Make sure that all supplies for electrical power, hydraulic pressure, and air pressure are turned off.	
2	 CAUTION For robots with protection type Clean Room Always cut the paint with a knife and grind the paint edge when disassembling parts of the robot! See Cut the paint or surface on the robot before replacing parts on page 118 .	
3	 DANGER Make sure that the ball screw is supported with something. The sudden drop of the ball screw due the lost of the axis-3 motor may cause danger.	
4	Hang a strong strap to the motor.	
5	Use a handheld dynamometer hooking to the strap and pull the dynamometer to make the tension falling in the allowed force range.  Note During the measurement, make sure that all interferences that may affect the force are removed. Pay attention to the force application direction.	Used belt: 100 New belt:240  xx2100001127
6	Fasten the screws on the transmission module to the recommended tightening torque.	Tightening torque: 2.6 Nm \pm 10%  xx2100001087

Continues on next page

	Action	Note
7	Use a sonic tension meter to measure the timing belt tension.	Used belt: 202 New belt:180
8	If the timing belt tension does not meet the requirement, loosen the motor screws and readjust.	

Refitting the axis-3 motor sub-assembly

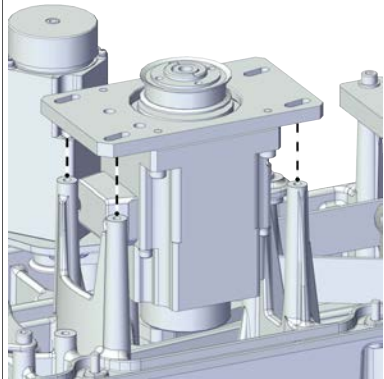

	Action	Note
1	<p>For robots with protection type Clean Room: Clean the joints that have been opened and wipe the parts free from particles with spirit on a lint free. See Cut the paint or surface on the robot before replacing parts on page 118</p> <p> Note</p> <p>After all repair work, wipe the Clean Room robot free from particles with spirit on a lint free cloth.</p>	
2	<p>Refit the motor to the outer arm.</p> <p> Tip</p> <p>Move the internal harness out of the way.</p>	 <p>xx2100001181</p>
3	<p>Refit the timing belt to the pulley on the ball screw and the motor. Ensure that the belt runs correctly in the grooves.</p>	<p>Timing belt A3: 3HAC070464-001</p>

Continues on next page

5 Repair

5.6.11 Replacing the outer arm

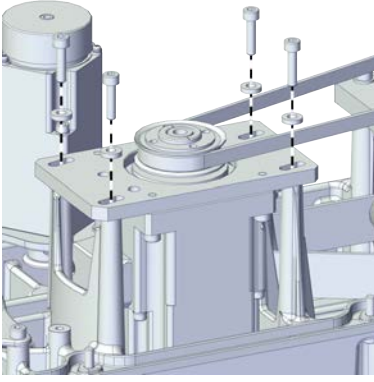
Continued

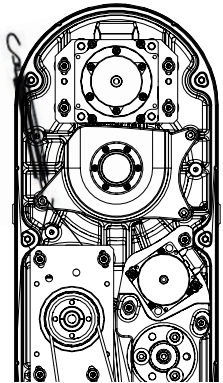
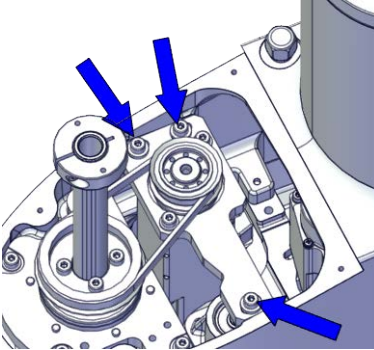
	Action	Note
4	Refit the screws and washers without fully tightened.	<p>Screws: Hex socket head cap screw M4x20 12.9 Lafre 2C2B/FC6.9 (4 pcs) Washers: Washer 4.3x10x2 steel (4 pcs) Tightening torque: 2.6 Nm \pm10%</p>  <p>xx2100001178</p>
5	Hang a strap to the motor.	
6	<p>Use a handheld dynamometer hooking to the strap and pull the dynamometer to make the tension falling in the allowed force range.</p> <p> Note</p> <p>During the measurement, make sure that all interferences that may affect the force are removed. Pay attention to the force application direction.</p>	 <p>xx2100001126</p>
7	Fasten the screws to the recommended tightening torque.	
8	Use a sonic tension meter to measure the timing belt tension.	<p>Used belt: 139 New belt:110</p>
9	If the timing belt tension does not meet the requirement, loosen the motor screws and readjust.	 <p>xx1800002887</p>

Continues on next page

	Action	Note
10	Remove the axis-3 belt tension adjustment tool.	

Refitting the axis-3 timing belt

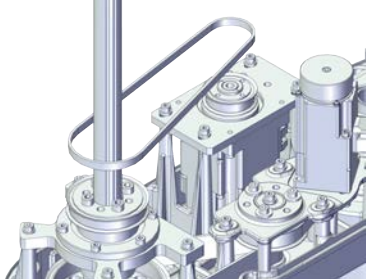
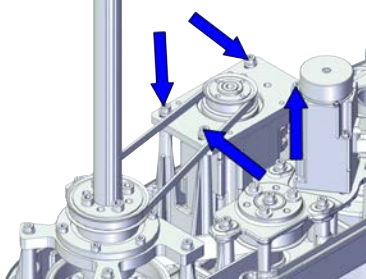
	Action	Note
1	<p>For robots with protection type Clean Room: Clean the joints that have been opened and wipe the parts free from particles with spirit on a lint free. See Cut the paint or surface on the robot before replacing parts on page 118</p> <p> Note After all repair work, wipe the Clean Room robot free from particles with spirit on a lint free cloth.</p>	
2	Refit the timing belt to the pulley on the ball screw and the motor. Ensure that the belt runs correctly in the grooves.	<p>Timing belt A3: 3HAC070464-001</p>  <p>xx2100001079</p>
3	Secure the screws and washers without fully tightened.	<p>Screws: Hex socket head cap screw M4x16 12.9 Lafre 2C2B/FC6.9 (4 pcs) Washers: Plain washer machining 4.2x9x2 steel (4 pcs) Tightening torque: 2.6 Nm ±10%</p>  <p>xx2100001078</p>
4	Hang a strap to the hook on the motor.	

Continues on next page

5 Repair

5.6.11 Replacing the outer arm

Continued

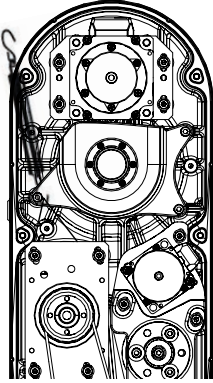

	Action	Note
5	<p>Use a handheld dynamometer hooking to the strap and pull the dynamometer to make the tension falling in the allowed force range.</p> <p> Note</p> <p>During the measurement, make sure that all interferences that may affect the force are removed. Pay attention to the force application direction.</p>	<p>Used belt: 36.6 New belt:40</p>  <p>xx2100001126</p>
6	Use a sonic tension meter to measure the timing belt tension.	Used belt: 139 New belt:110
7	If the timing belt tension does not meet the requirement, loosen the motor screws and readjust.	

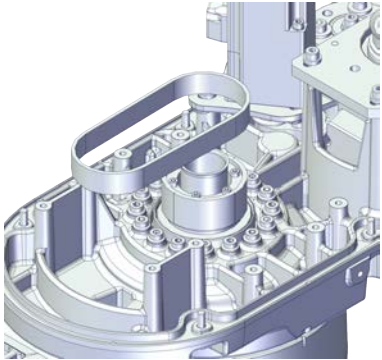
Refitting the axis-2 motor sub-assembly

	Action	Note
1	<p>For robots with protection type Clean Room: Clean the joints that have been opened and wipe the parts free from particles with spirit on a lint free. See Cut the paint or surface on the robot before replacing parts on page 118</p> <p> Note</p> <p>After all repair work, wipe the Clean Room robot free from particles with spirit on a lint free cloth.</p>	
2	Refit the axis-2 timing belt onto the pulley on the axis-2 gearbox.	 <p>xx2100001048</p>

Continues on next page

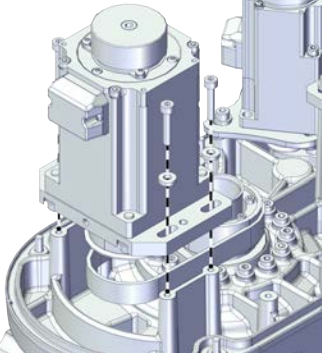
5.6.11 Replacing the outer arm
Continued

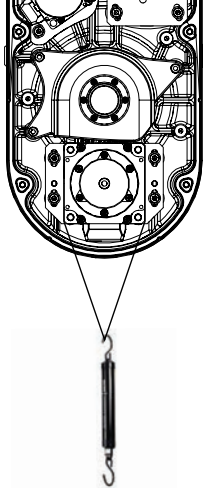
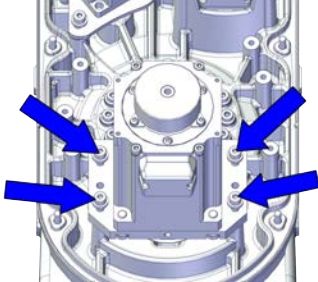
	Action	Note
3	Refit the motor and refit the timing belt to the motor. Ensure that the belt runs correctly in the grooves.	Screws: Hex socket head cap screw M4x20 12.9 Lafre 2C2B/FC6.9 (4 pcs)
4	Refit the screws and washers without fully tightened.	Washers: Plain washer machining 4.2x9x2 steel (4 pcs) Tightening torque: 2.3 Nm ±10%  xx2100001046 Timing belt A2: 3HAC061861-001
5	Hang a strap to the motor.	
6	Use a handheld dynamometer hooking to the strap and pull the dynamometer to make the tension falling in the allowed force range.  Note During the measurement, make sure that all interferences that may affect the force are removed. Pay attention to the force application direction.  Tip If the ball screw will interfere with the handheld dynamometer, adjust the ball screw manually.	Used belt: 64.7 New belt:70  xx2100001125
7	Fasten the screws to the recommended tightening torque.	Tightening torque: 2.3 Nm ±10%  xx2100001176

Continues on next page



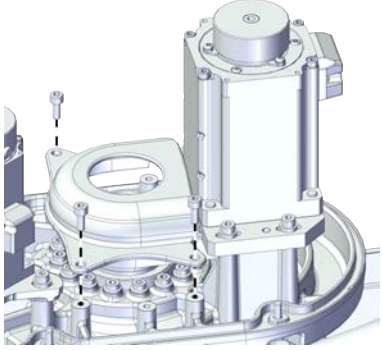

5 Repair

5.6.11 Replacing the outer arm



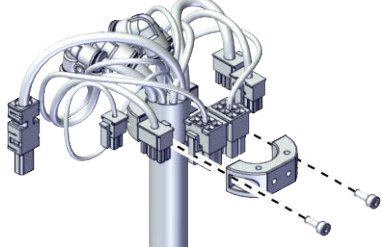

Continued

	Action	Note
8	Use a sonic tension meter to measure the timing belt tension.	Used belt: 315 New belt:260
9	If the timing belt tension does not meet the requirement, loosen the motor screws and readjust.	
10	Refit the pulley protection cover and secure with screws.	Screws: Hex socket head cap screw M4x10 12.9 Lafre 2C2B/FC6.9 (3 pcs) Tightening torque: 0.8 Nm  xx2100001047

Refitting the cable ferrule and bracket in the outer arm

	Action	Note
1	For robots with protection type Clean Room: Clean the joints that have been opened and wipe the parts free from particles with spirit on a lint free. See Cut the paint or surface on the robot before replacing parts on page 118  Note After all repair work, wipe the Clean Room robot free from particles with spirit on a lint free cloth.	
2	Lay the internal harness in a natural state without distortion.	
3	Refit the cable ferrule and secure it with the screws.  Tip The air hoses should face the process hub side.  Tip The position with wrapped tape is the marked position for the cable ferrule.  Tip Align all the cable ferrules so that the cable is in a natural bending position to avoid twisting.	Screws: Hex socket head cap screw M3x8 12.9 Lafre 2C2B/FC6.9 (2 pcs) Tightening torque: 1.2 Nm \pm 10%  xx1800002849

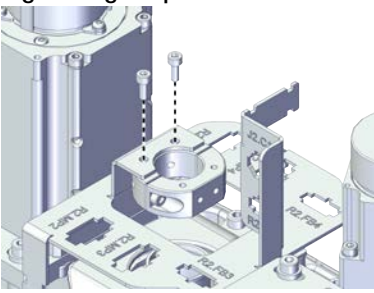
Continues on next page

	Action	Note
4	<p>Secure the cable ferrule to the bracket.</p> <p> Tip</p> <p>Align all the cable ferrules so that the cable is in a natural bending position to avoid twisting.</p> <p> Note</p> <p>The harness are not visible due to the cleanness requirements of the illustration. They are still existing inside the cable ferrule in the actual situation.</p>	<p>Screws: Hex socket head cap screw M3x8 12.9 Lafre 2C2B/FC6.9 (2 pcs)</p> <p>Tightening torque: 1.2 Nm ±10%</p>  <p>xx2100000940</p>
5	<p>Refit the bracket without securing.</p> <p> Tip</p> <p>Do not secure it with the screws before the cable ferrule installed well.</p> <p> Note</p> <p>The harness are not visible due to the cleanness requirements of the illustration. They are still existing inside the cable ferrule in the actual situation.</p>	







Reconnecting the connector for PB

	Action	Note
1	<p>For robots with protection type Clean Room:</p> <p>Clean the joints that have been opened and wipe the parts free from particles with spirit on a lint free. See Cut the paint or surface on the robot before replacing parts on page 118</p> <p> Note</p> <p>After all repair work, wipe the Clean Room robot free from particles with spirit on a lint free cloth.</p>	

5 Repair

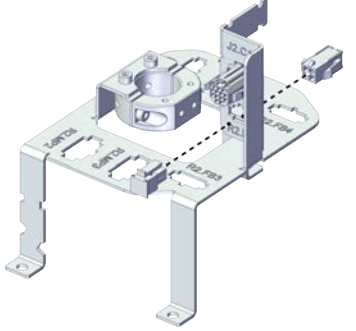
5.6.11 Replacing the outer arm

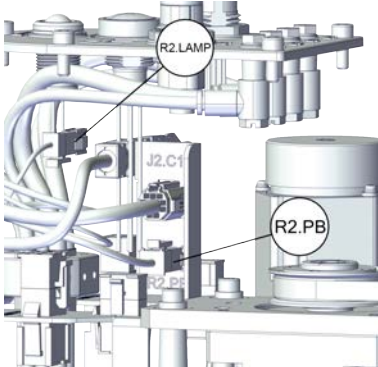





Continued

	Action	Note
2	<p>Insert the female head of the PB connector to the bracket accordingly.</p> <p> Tip</p> <p>The mistake proofing measure has been applied to the connectors, the connectors may be damaged if excessive force is used.</p> <p> Note</p> <p>The harness are not visible due to the cleanliness requirements of the illustration. They are still existing inside the cable ferrule in the actual situation.</p>	 <p>xx2100001031</p>
3	<p>Reconnect the connector.</p> <ul style="list-style-type: none"> • R2.PB • R2.LAMP <p> Tip</p> <p>See the number markings on the connectors for help to find the corresponding connector.</p>	 <p>xx2100001030</p>
4	<p>Route and secure the cabling with cable straps if needed.</p> <p> CAUTION</p> <p>Correct cable routing is highly important. If the cables are routed incorrectly the cables can be damaged.</p>	

Reconnecting the connectors for axis-4 motor

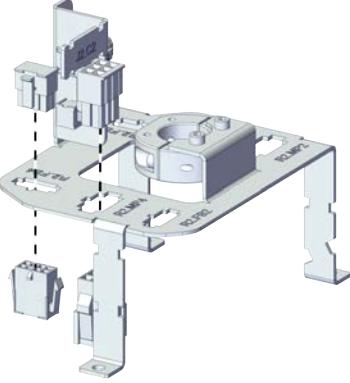
	Action	Note
1	<p>For robots with protection type Clean Room: Clean the joints that have been opened and wipe the parts free from particles with spirit on a lint free. See Cut the paint or surface on the robot before replacing parts on page 118</p> <p> Note</p> <p>After all repair work, wipe the Clean Room robot free from particles with spirit on a lint free cloth.</p>	

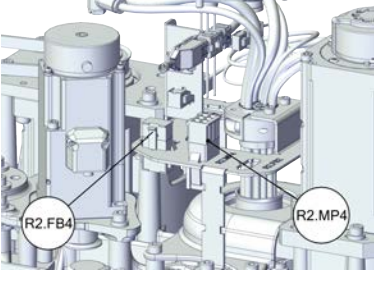
Continues on next page

	Action	Note
	<p>Insert the female head of the connectors to the bracket accordingly.</p> <p> Tip</p> <p>The mistake proofing measure has been applied to the connectors, the connectors may be damaged if excessive force is used.</p> <p> Note</p> <p>The harness are not visible due to the cleanness requirements of the illustration. They are still existing inside the cable ferrule in the actual situation.</p>	 <p>xx2100000939</p>
2	<p>Reconnect the connectors.</p> <ul style="list-style-type: none"> • R2.MP4 • R2.FB4 <p> Tip</p> <p>See the number markings on the connectors for help to find the corresponding connector.</p>	 <p>xx2100000938</p>
3	<p>Route the cabling on the axis-4 motor.</p> <p> CAUTION</p> <p>Correct cable routing is highly important. If the cables are routed and secured incorrectly the cables can be damaged.</p>	

Reconnecting the connectors for axis-3 motor







	Action	Note
1	<p>For robots with protection type Clean Room: Clean the joints that have been opened and wipe the parts free from particles with spirit on a lint free. See Cut the paint or surface on the robot before replacing parts on page 118</p> <p> Note</p> <p>After all repair work, wipe the Clean Room robot free from particles with spirit on a lint free cloth.</p>	

Continues on next page

5 Repair

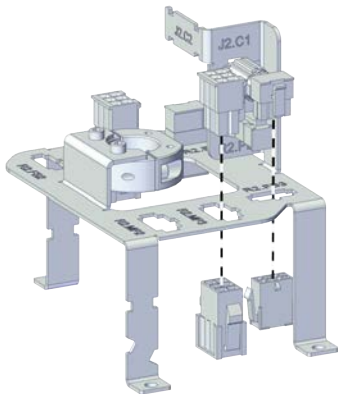
5.6.11 Replacing the outer arm

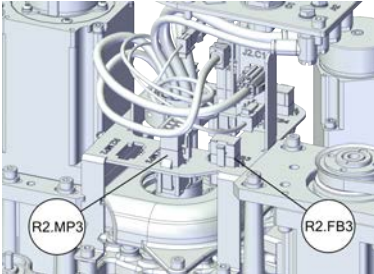





Continued

	Action	Note
2	<p>Insert the female head of the connectors to the bracket accordingly.</p> <p> Tip</p> <p>The mistake proofing measure has been applied to the connectors, the connectors may be damaged if excessive force is used.</p> <p> Note</p> <p>The harness are not visible due to the cleanness requirements of the illustration. They are still existing inside the cable ferrule in the actual situation.</p>	 <p>xx2100000937</p>
3	<p>Reconnect the connectors.</p> <ul style="list-style-type: none"> • R2.MP3 • R2.FB3 <p> Tip</p> <p>See the number markings on the connectors for help to find the corresponding connector.</p>	 <p>xx2100000936</p>
4	<p>Route the cabling on the axis-3 motor.</p> <p> CAUTION</p> <p>Correct cable routing is highly important. If the cables are routed and secured incorrectly the cables can be damaged.</p>	

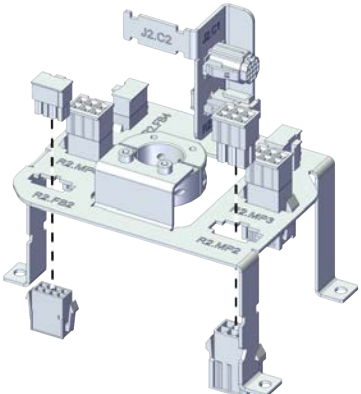

Reconnecting the connectors for axis-2 motor

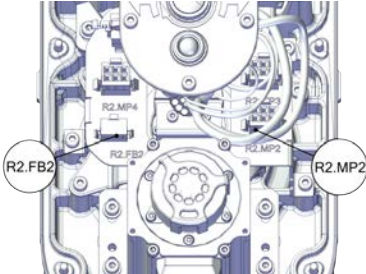
	Action	Note
1	<p>For robots with protection type Clean Room: Clean the joints that have been opened and wipe the parts free from particles with spirit on a lint free. See Cut the paint or surface on the robot before replacing parts on page 118</p> <p> Note</p> <p>After all repair work, wipe the Clean Room robot free from particles with spirit on a lint free cloth.</p>	

Continues on next page

	Action	Note
2	<p>Insert the female head of the connectors to the bracket accordingly.</p> <p> Tip</p> <p>The mistake proofing measure has been applied to the connectors, the connectors may be damaged if excessive force is used.</p> <p> Note</p> <p>The harness are not visible due to the cleanness requirements of the illustration. They are still existing inside the cable ferrule in the actual situation.</p>	 <p>xx2100000935</p>
3	<p>Reconnect the connectors.</p> <ul style="list-style-type: none"> • R2.MP2 • R2.FB2 <p> Tip</p> <p>See the number markings on the connectors for help to find the corresponding connector.</p>	 <p>xx2100000934</p>
4	<p>Route the cabling behind the axis-2 motor.</p> <p> CAUTION</p> <p>Correct cable routing is highly important. If the cables are routed and secured incorrectly the cables can be damaged.</p>	

Reconnecting the air hoses, CP/CS cabling and Ethernet cabling (if equipped)







	Action	Note
1	<p>For robots with protection type Clean Room: Clean the joints that have been opened and wipe the parts free from particles with spirit on a lint free. See Cut the paint or surface on the robot before replacing parts on page 118</p> <p> Note</p> <p>After all repair work, wipe the Clean Room robot free from particles with spirit on a lint free cloth.</p>	
2	<p>Route the air hoses on the process hub behind the bracket.</p> <p> CAUTION</p> <p>Correct cable routing is highly important. If the cables are routed and secured incorrectly the cables can be damaged.</p>	

Continues on next page

5 Repair

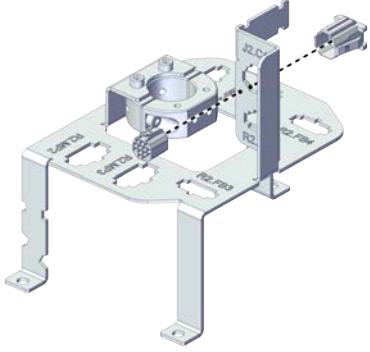
5.6.11 Replacing the outer arm

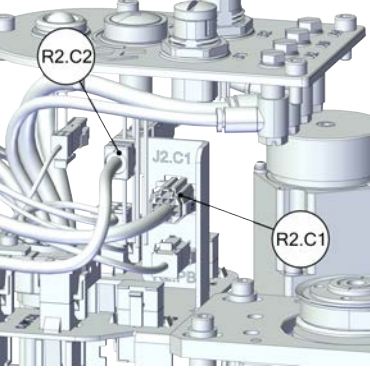

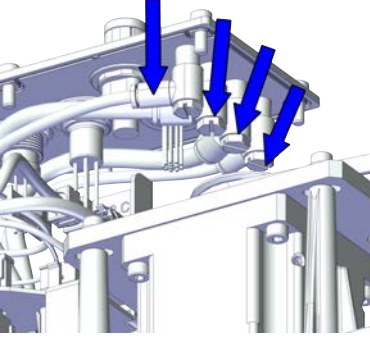
Continued

	Action	Note
3	<p>Insert the female head of the C1 cabling connector to the bracket accordingly.</p> <p> Tip</p> <p>The mistake proofing measure has been applied to the connectors, the connectors may be damaged if excessive force is used.</p> <p> Note</p> <p>The harness are not visible due to the cleanness requirements of the illustration. They are still existing inside the cable ferrule in the actual situation.</p>	 <p>xx2100001034</p>
4	<p>For robots with C1 cabling</p> <p>Reconnect the connector.</p> <ul style="list-style-type: none"> • R2.C1 <p> Tip</p> <p>See the number markings on the air hoses for help to find the corresponding air hoses.</p> <p>The air hoses with the same number connect to the same L-shaped connector.</p>	 <p>xx2100001033</p>
5	<p>For robots with C2 cabling</p> <p>Reconnect the connector.</p> <ul style="list-style-type: none"> • R1.C2 <p> Tip</p> <p>See the number markings on the air hoses for help to find the corresponding air hoses.</p> <p>The air hoses with the same number connect to the same L-shaped connector.</p>	
6	<p>Secure the C2 cabling to the C2 bracket with the cable straps.</p>	
7	<p>Reconnect the air hoses in a cross pattern with the L-shaped connectors.</p> <p> Tip</p> <p>See the number markings on the air hoses for help to find the corresponding air hoses.</p> <p>The air hoses with the same number connect to the same Y-shaped connector.</p>	 <p>xx2100001032</p>

Continues on next page

	Action	Note
8	<p>Route and secure the cabling with cable straps if needed.</p> <p> CAUTION</p> <p>Correct cable routing is highly important. If the cables are routed and secured incorrectly the cables can be damaged.</p>	

Securing the bracket in the outer arm

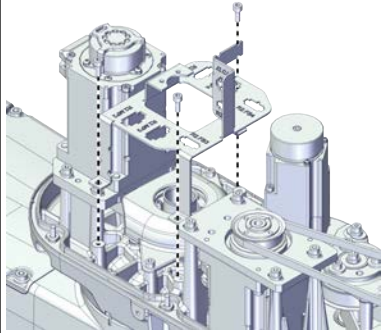
	Action	Note
1	<p>For robots with protection type Clean Room: Clean the joints that have been opened and wipe the parts free from particles with spirit on a lint free. See Cut the paint or surface on the robot before replacing parts on page 118</p> <p> Note</p> <p>After all repair work, wipe the Clean Room robot free from particles with spirit on a lint free cloth.</p>	
2	<p>Refit the bracket.</p> <p> Tip</p> <p>Do not secure it with the screws before the cable ferrule installed well.</p> <p> Note</p> <p>The harness are not visible due to the cleanness requirements of the illustration. They are still existing inside the cable ferrule in the actual situation.</p>	<p>Screws: Hex socket head cap screw M4x10 12.9 Lafre 2C2B/FC6.9 (3 pcs)</p> <p>Tightening torque: 1.2 Nm ±10%</p>  <p>xx2100000941</p>

For Clean Room/ IP54 robots

Refitting the shaft for Clean Room/ IP54 robots



	Action	Note
1	<p>For robots with protection type Clean Room: Clean the joints that have been opened and wipe the parts free from particles with spirit on a lint free. See Cut the paint or surface on the robot before replacing parts on page 118</p> <p> Note</p> <p>After all repair work, wipe the Clean Room robot free from particles with spirit on a lint free cloth.</p>	

Continues on next page

5 Repair

5.6.11 Replacing the outer arm

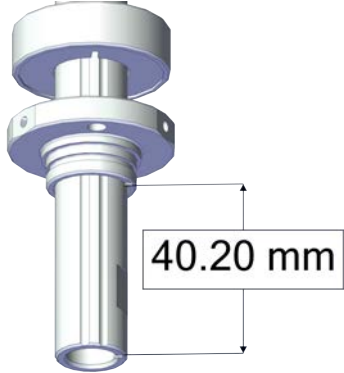
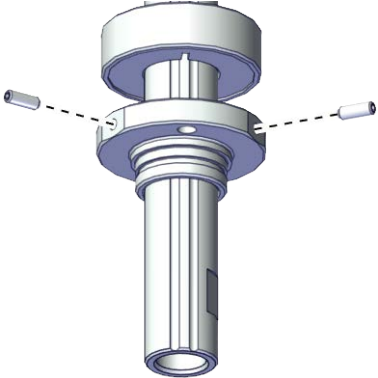
Continued

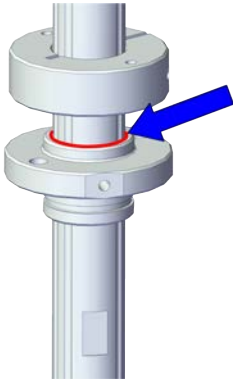
	Action	Note
2	<p>For robots with protection class IP54 (option 3350-540) For robots with protection type Clean Room (option 3351-1) Install the shaft to the ball screw at 40.2 mm position to the lower of the ball screw.</p>	 <p>xx1900001617</p>
3	<p>For robots with protection class IP54 (option 3350-540) For robots with protection type Clean Room (option 3351-1) Secure the shaft to the ball screw with the screws.</p>	<p>Screws: Hexagon socket set screws with flat point, ISO 4026 stainless steel M3x8 (2 pcs) Tightening torque: 0.4 Nm \pm10%</p>  <p>xx1900001616</p>
4	<p>For robots with protection class IP54 (option 3350-540) Apply the glue to the upper contacted zone between the shaft and the ball screw.</p> <p> Note</p> <p>Fulfill the gaps on the ball screw in this contacted zone to make a sealing structure.</p>	 <p>xx1900001805</p>

Continues on next page

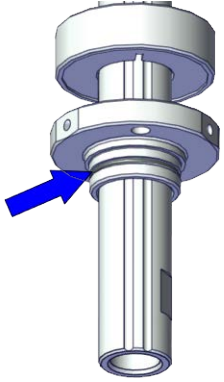
	Action	Note
5	<p>For robots with protection class IP54 (option 3350-540) For robots with protection type Clean Room (option 3351-1) Insert the O-ring to the shaft.</p> <p> Note Replace the o-ring if needed.</p>	 <p>xx1900001615</p>

Refitting the lower bellow to outer arm

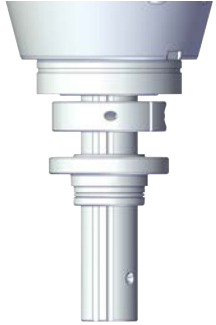

	Action	Note
1	<p>For robots with protection type Clean Room: Clean the joints that have been opened and wipe the parts free from particles with spirit on a lint free. See Cut the paint or surface on the robot before replacing parts on page 118</p> <p> Note After all repair work, wipe the Clean Room robot free from particles with spirit on a lint free cloth.</p>	
2	<p>For robots with protection class IP54 (option 3350-540) Apply the glue to the outer arm.</p>	 <p>xx2100002409</p>
3	<p>For robots with protection class IP54 (option 3350-540) For robots with protection type Clean Room (option 3351-1) Install the bellow to the shaft.</p>	

Continues on next page

5 Repair

5.6.11 Replacing the outer arm

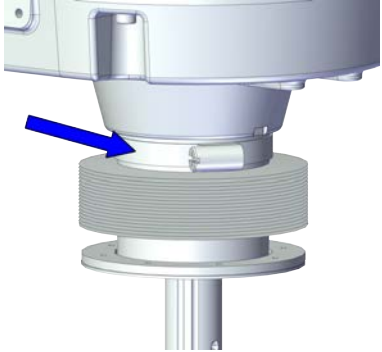
Continued

	Action	Note
4	<p>For robots with protection class IP54 (option 3350-540) For robots with protection type Clean Room (option 3351-1) Pull the upper end of the bellow to the outer arm.</p> <p> Tip</p> <p>For robots with protection class IP54 (option 3350-540) Hold the bellow for a little while until it's attached to the housing.</p>	<p>Tightening torque: 2.5 Nm \pm10%</p> 
5	<p>For robots with protection class IP54 (option 3350-540) Install the bellow gaskets to the bellow.</p> <p> Tip</p> <p>The angle between the gap on the bellow gasket and gap on the inner bellow gasket should be 90 degrees.</p>	<p>xx2100002408</p>
6	<p>For robots with protection class IP54 (option 3350-540) For robots with protection type Clean Room (option 3351-1) Secure them with the clamp.</p> <p> Tip</p> <p>The opening part of the clamp should be in the opposite position to the gap on the bellow gasket.</p>	

Refitting the lower cover and the flange with bearing

	Action	Note
1	<p>For robots with protection type Clean Room: Clean the joints that have been opened and wipe the parts free from particles with spirit on a lint free. See Cut the paint or surface on the robot before replacing parts on page 118</p> <p> Note</p> <p>After all repair work, wipe the Clean Room robot free from particles with spirit on a lint free cloth.</p>	

Continues on next page

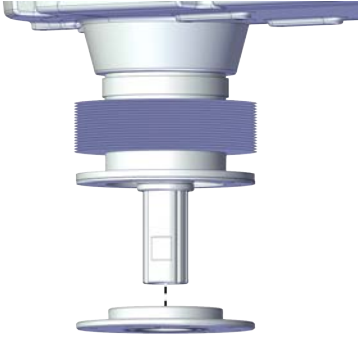
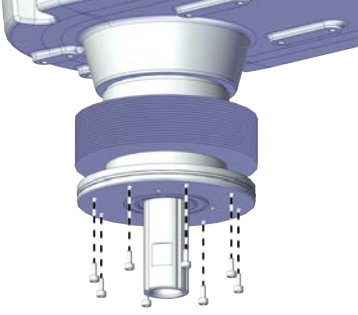
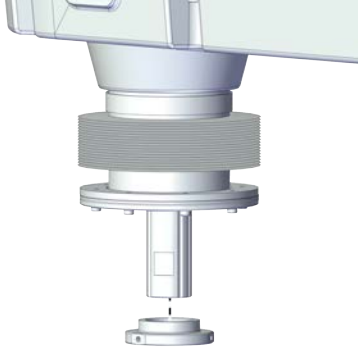
	Action	Note
2	<p>For robots with protection class IP54 (option 3350-540) For robots with protection type Clean Room (option 3351-1) Install the flange with bearing to the shaft.</p>	 <p>xx2100002407</p>
3	<p>For robots with protection class IP54 (option 3350-540) For robots with protection type Clean Room (option 3351-1) Refit the screws to the flange with bearing.</p>	<p>Screws: Hex socket head cap screw M2.5x6 12.9 Lafre 2C2B/FC6.9 (8 pcs) Tightening torque: 0.8 Nm ±10%</p>  <p>xx2100002406</p>
4	<p>For robots with protection class IP54 (option 3350-540) For robots with protection type Clean Room (option 3351-1) Refit the lower cover to the ball screw.</p>	 <p>xx2100002405</p>

Continues on next page

5 Repair

5.6.11 Replacing the outer arm

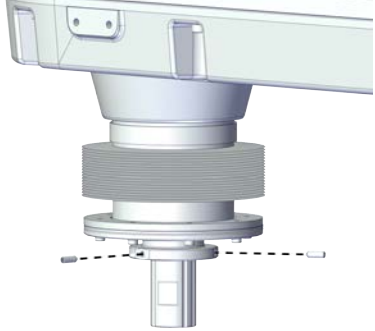

Continued

	Action	Note
5	<p>For robots with protection class IP54 (option 3350-540) For robots with protection type Clean Room (option 3351-1) Refit the locking screws.</p>	<p>Screws: Hexagon socket set screws with flat point, ISO 4026 stainless steel M3x8 (2 pcs) Tightening torque: 0.4 Nm \pm10%</p>  <p>xx2100002404</p>

Refitting the cover of the outer arm

	Action	Note
1	<p>For robots with protection type Clean Room: Clean the joints that have been opened and wipe the parts free from particles with spirit on a lint free. See Cut the paint or surface on the robot before replacing parts on page 118</p> <p> Note</p> <p>After all repair work, wipe the Clean Room robot free from particles with spirit on a lint free cloth.</p>	

Continues on next page

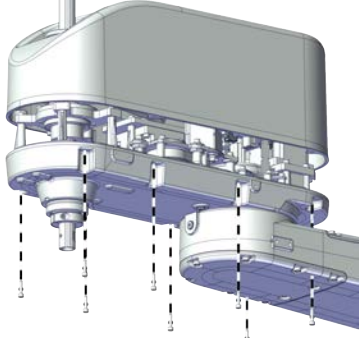
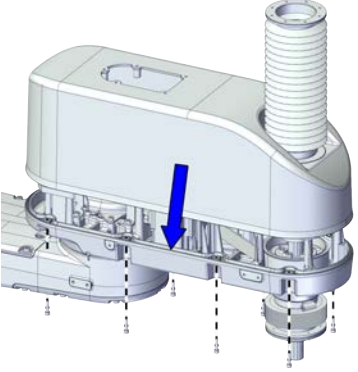
	Action	Note
2	<p>Refit the cover.</p> <p> Note</p> <p>For robots with protection class IP54 (option 3350-540)</p> <p>For robots with protection type Clean Room (option 3351-1)</p> <p>Refit the cover with bellow.</p> <p>Check the gasket for the outer arm cover.</p> <p> Tip</p> <p>Replace the gasket if needed.</p> <p> CAUTION</p> <p>The gasket is in the outer arm.</p>	<p>Screw: Hex socket head cap screw M4x16 12.9 Lafre 2C2B/FC6.9 (8 pcs)</p> <p>Tightening torque: 2 Nm ±10%</p> <p>For robots with protection class IP30 (option 3350-300)</p>  <p>xx210000933</p>
3	<p>Refit the screws.</p>	<p>For robots with protection class IP54 (option 3350-540)</p> <p>For robots with protection type Clean Room (option 3351-1)</p>  <p>xx2100002427</p>

For Clean Room/ IP54 robots

Refitting the top cover and the flange with bearing



	Action	Note
1	<p>For robots with protection type Clean Room:</p> <p>Clean the joints that have been opened and wipe the parts free from particles with spirit on a lint free. See Cut the paint or surface on the robot before replacing parts on page 118</p> <p> Note</p> <p>After all repair work, wipe the Clean Room robot free from particles with spirit on a lint free cloth.</p>	

Continues on next page

5 Repair

5.6.11 Replacing the outer arm

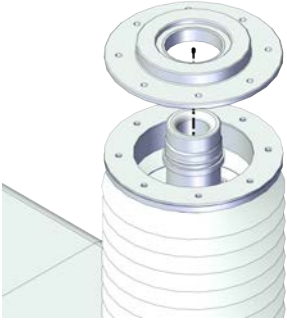
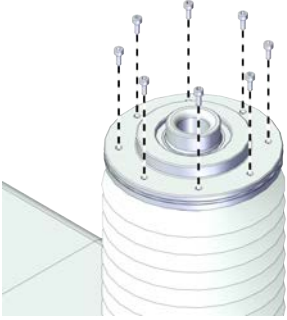
Continued

	Action	Note
2	<p>For robots with protection class IP54 (option 3350-540)</p> <p>For robots with protection type Clean Room (option 3351-1)</p> <p>Install the flange with bearing to the extension shaft.</p>	 <p>xx2100002402</p>
3	<p>For robots with protection class IP54 (option 3350-540)</p> <p>For robots with protection type Clean Room (option 3351-1)</p> <p>Refit the screws to the flange with bearing.</p>	<p>Screws: Hex socket head cap screw M2.5x6 12.9 Lafre 2C2B/FC6.9 (8 pcs)</p> <p>Tightening torque: 0.8 Nm \pm10%</p>  <p>xx2100002401</p>
4	<p>For robots with protection class IP54 (option 3350-540)</p> <p>For robots with protection type Clean Room (option 3351-1)</p> <p>Refit the top cover to the ball screw.</p> <p> Tip</p> <p>The top surface of the cover should be flush with the top end of the ball screw.</p>	 <p>xx2100002399</p>

Continues on next page

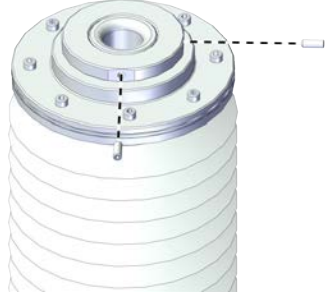
	Action	Note
5	<p>For robots with protection class IP54 (option 3350-540) For robots with protection type Clean Room (option 3351-1) Refit the locking screws.</p>	<p>Screws: Hexagon socket set screws with flat point, ISO 4026 stainless steel M3x8 (2 pcs) Tightening torque: 0.4 Nm ±10%</p>  <p>xx2100002398</p>



Securing the process hub to outer arm cover

	Action	Note
1	<p>For robots with protection type Clean Room: Clean the joints that have been opened and wipe the parts free from particles with spirit on a lint free. See Cut the paint or surface on the robot before replacing parts on page 118</p> <p> Note</p> <p>After all repair work, wipe the Clean Room robot free from particles with spirit on a lint free cloth.</p>	
2	<p>Insert the process hub from the outer arm cover.</p>	

5 Repair

5.6.11 Replacing the outer arm

Continued

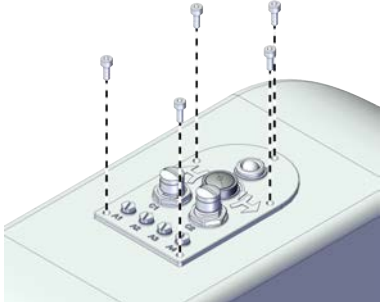
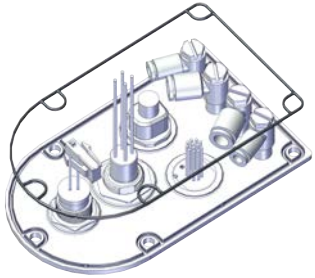
	Action	Note
3	<p>Secure the process hub to the outer arm cover with the screws.</p> <p> Note</p> <p>For robots with protection class IP54 (option 3350-540)</p> <p>For robots with protection type Clean Room (option 3351-1)</p> <p>Check the gasket for the process hub.</p> <p> Tip</p> <p>Replace the gasket if needed.</p> <p> CAUTION</p> <p>Be aware of the cabling that is attached to the cover! The cover can not be removed completely until the connectors are disconnected, as shown in following steps.</p>	<p>Screws: Hex socket head cap screw M4x10 12.9 Lafre 2C2B/FC6.9 (5 pcs)</p> <p>Tightening torque: 2.6 Nm±10%</p> <p>For robots with protection class IP30 (option 3350-300)</p>  <p>xx2100000932</p> <p>For robots with protection class IP54 (option 3350-540)</p> <p>For robots with protection type Clean Room (option 3351-1)</p>  <p>xx2100002438</p>

Concluding procedure

	Action	Note
1	<p>For robots with protection type Clean Room: Seal and paint the joints that have been opened. See Cut the paint or surface on the robot before replacing parts on page 118</p> <p> Note</p> <p>After all repair work, wipe the Clean Room robot free from particles with spirit on a lint free cloth.</p>	
2	Recalibrate the robot.	Calibration is detailed in section Calibration on page 945 .

Continues on next page

	Action	Note
3	 DANGER Make sure all safety requirements are met when performing the first test run.	

5 Repair

5.7.1 Replacing the axis-1 motor sub-assembly

5.7 Motors

5.7.1 Replacing the axis-1 motor sub-assembly

Location of the axis-1 motor sub-assembly

The axis-1 motor sub-assembly is located as shown in the figure.

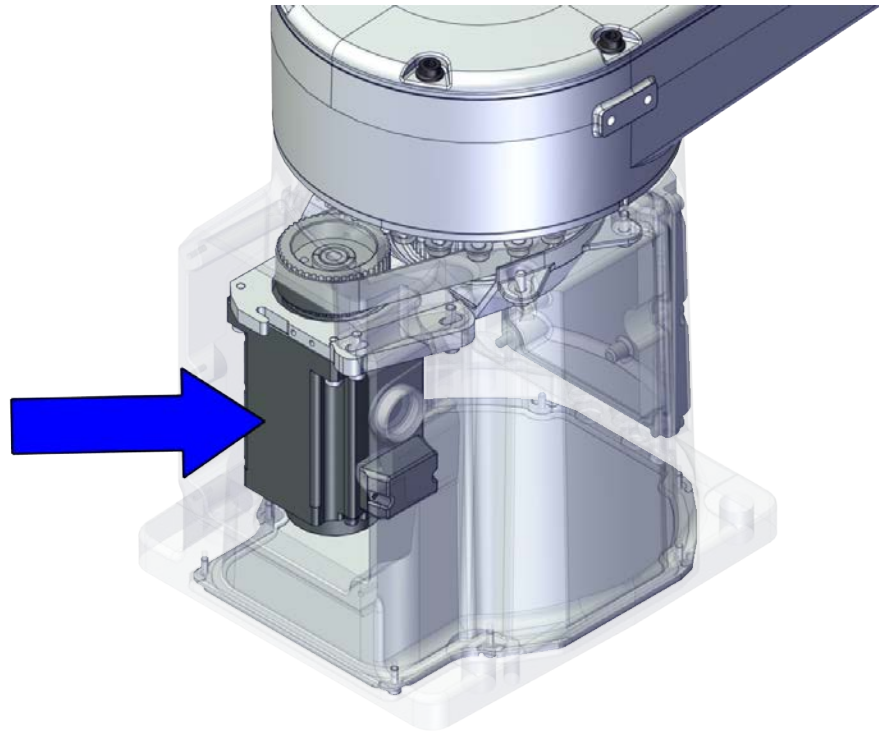

xx2100001014

Required spare parts



Note

The spare part numbers that are listed in the table can be out of date. See the latest spare parts of the IRB 920 via myABB Business Portal, www.abb.com/myABB.

Spare part	Article number	Note
Motor with pulley A1	3HAC076569-001	
Timing belt A1	3HAC070449-001	

Required tools and equipment

Equipment	Article number	Note
Standard toolkit	-	Content is defined in section Standard toolkit on page 996 .

Continues on next page

Equipment	Article number	Note
Calibration toolbox, Axis Calibration	3HAC055412-001	Delivered as a set of calibration tools. Required if Axis Calibration is the valid calibration method for the robot.
Sonic tension meter	-	Used for measuring the timing belt tension.
Handheld dynamometer	-	Used for measuring the timing belt tension.

Required consumables

Consumable	Article number	Note
Cable straps	-	
Grease	3HAC029132-001	FM 222

Deciding calibration routine

Decide which calibration routine to be used, based on the information in the table. Depending on which routine is chosen, action might be required prior to beginning the repair work of the robot, see the table.

	Action	Note
1	<p>Decide which calibration routine to use for calibrating the robot.</p> <ul style="list-style-type: none"> Reference calibration. External cable packages (DressPack) and tools can stay fitted on the robot. Fine calibration. All external cable packages (DressPack) and tools must be removed from the robot. 	
	<p>If the robot is to be calibrated with reference calibration:</p> <p>Find previous reference values for the axis or create new reference values. These values are to be used after the repair procedure is completed, for calibration of the robot.</p> <p>If no previous reference values exist, and no new reference values can be created, then reference calibration is not possible.</p>	<p>Follow the instructions given in the reference calibration routine on the FlexPendant to create reference values.</p> <p>Creating new values requires possibility to move the robot.</p> <p>Read more about reference calibration for Axis Calibration in Reference calibration routine on page 957.</p>
	<p>If the robot is to be calibrated with fine calibration:</p> <p>Remove all external cable packages (DressPack) and tools from the robot.</p>	

Continues on next page

5 Repair



5.7.1 Replacing the axis-1 motor sub-assembly

Continued

Removing the axis-1 motor sub-assembly



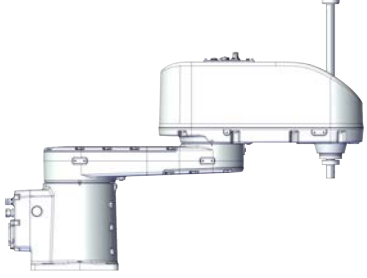

Use these procedures to remove the axis-1 motor sub-assembly.

Preparations before removing the axis-1 motor sub-assembly

	Action	Note
1	Decide which calibration routine to use, and take actions accordingly prior to beginning the repair procedure.	
2	<p>If there is no enough space for the maintenance work, remove the robot from the wall and place it on the maintenance bracket.</p> <p> CAUTION</p> <p>Do not lay down the robot during the transportation, always keep it straight. If the robot lay down in any situation, the grease may come out from gearbox.</p>	
3	Jog all axes to zero position.	 <p>xx2100000930</p>
4	<p> DANGER</p> <p>Turn off all:</p> <ul style="list-style-type: none"> • electric power supply • hydraulic pressure supply • air pressure supply <p>to the robot, before entering the safeguarded space.</p>	
5	<p> CAUTION</p> <p>For robots with protection type Clean Room Always cut the paint with a knife and grind the paint edge when disassembling parts of the robot! See <i>Cut the paint or surface on the robot before replacing parts on page 118.</i></p>	

Continues on next page

Removing the process hub screws

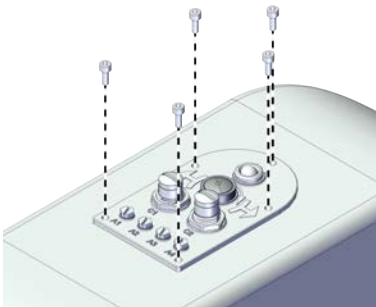
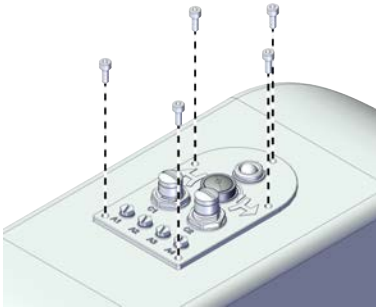
	Action	Note
1	 DANGER Make sure that all supplies for electrical power, hydraulic pressure, and air pressure are turned off.	
2	 CAUTION For robots with protection type Clean Room Always cut the paint with a knife and grind the paint edge when disassembling parts of the robot! See Cut the paint or surface on the robot before replacing parts on page 118 .	
3	Remove the screws on the process hub.  Note For robots with protection class IP54 (option 3350-540) For robots with protection type Clean Room (option 3351-1) Remove the screws on the process hub and take out the gasket.  Tip Check the gasket and replace it if needed.	For robots with protection class IP30  xx2100000932 For robots with protection class IP54 (option 3350-540) For robots with protection type Clean Room (option 3351-1)  xx2100000932
4	Insert the process hub to the outer arm.	

Continues on next page





5 Repair

5.7.1 Replacing the axis-1 motor sub-assembly

Continued

For Clean Room/ IP54 robots

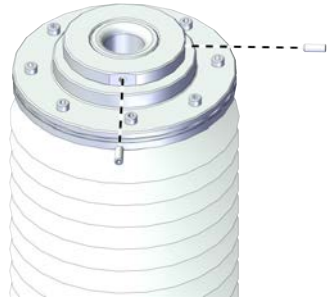
Removing the top cover and the flange with bearing



	Action	Note
1	 DANGER Make sure that all supplies for electrical power, hydraulic pressure, and air pressure are turned off.	
2	 CAUTION For robots with protection type Clean Room Always cut the paint with a knife and grind the paint edge when disassembling parts of the robot! See Cut the paint or surface on the robot before replacing parts on page 118 .	
3	For robots with protection class IP54 (option 3350-540) For robots with protection type Clean Room (option 3351-1) Loose the locking screws.	 xx2100002398
4	For robots with protection class IP54 (option 3350-540) For robots with protection type Clean Room (option 3351-1) Remove the top cover from the ball screw.	 xx2100002399

Continues on next page

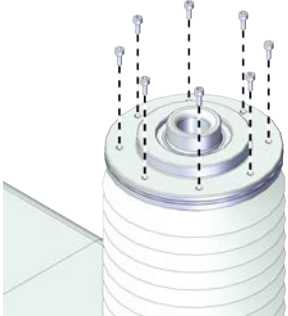
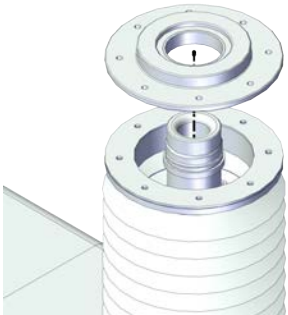
5.7.1 Replacing the axis-1 motor sub-assembly
Continued

	Action	Note
5	<p>For robots with protection class IP54 (option 3350-540)</p> <p>For robots with protection type Clean Room (option 3351-1)</p> <p>Remove the screws on the flange with bearing.</p>	 <p>xx2100002401</p>
6	<p>For robots with protection class IP54 (option 3350-540)</p> <p>For robots with protection type Clean Room (option 3351-1)</p> <p>Remove the flange with bearing.</p>	 <p>xx2100002402</p>

Removing the cover of the outer arm



	Action	Note
1	 <p>DANGER</p> <p>Make sure that all supplies for electrical power, hydraulic pressure, and air pressure are turned off.</p>	
2	 <p>CAUTION</p> <p>For robots with protection type Clean Room</p> <p>Always cut the paint with a knife and grind the paint edge when disassembling parts of the robot! See Cut the paint or surface on the robot before replacing parts on page 118.</p>	

Continues on next page



5 Repair

5.7.1 Replacing the axis-1 motor sub-assembly

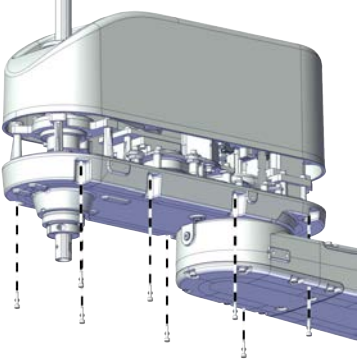
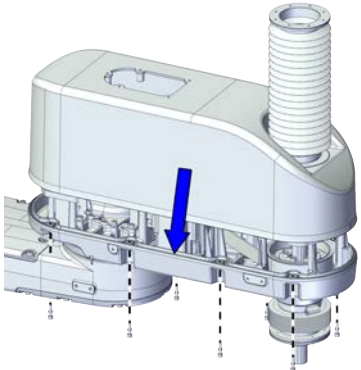
Continued





	Action	Note
3	<p>Remove the screws on the cover of the outer arm and remove the cover.</p> <p> Note</p> <p>For robots with protection class IP54 (option 3350-540) For robots with protection type Clean Room (option 3351-1) Remove the cover with bellow and housing.</p> <p> Note</p> <p>The bellow does not need to be removed separately.</p> <p> Tip</p> <p>Check the gasket and replace it if needed.</p>	<p>For robots with protection class IP30</p>  <p>xx210000933</p> <p>For robots with protection class IP54 (option 3350-540) For robots with protection type Clean Room (option 3351-1)</p>  <p>xx2100002427</p>

Disconnecting the air hoses, C1 cabling and C2 cabling (if equipped)

	Action	Note
1	<p> DANGER</p> <p>Make sure that all supplies for electrical power, hydraulic pressure, and air pressure are turned off.</p>	
2	<p> CAUTION</p> <p>For robots with protection type Clean Room Always cut the paint with a knife and grind the paint edge when disassembling parts of the robot! See Cut the paint or surface on the robot before replacing parts on page 118.</p>	

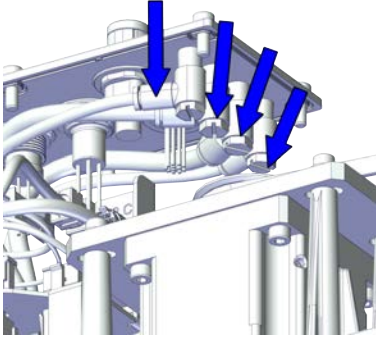
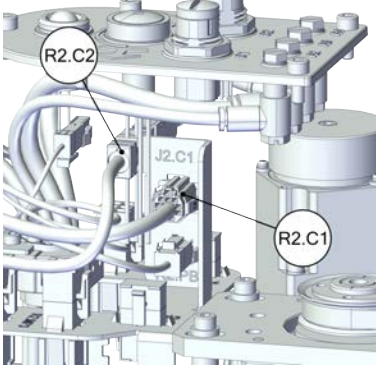
Continues on next page

5.7.1 Replacing the axis-1 motor sub-assembly
Continued

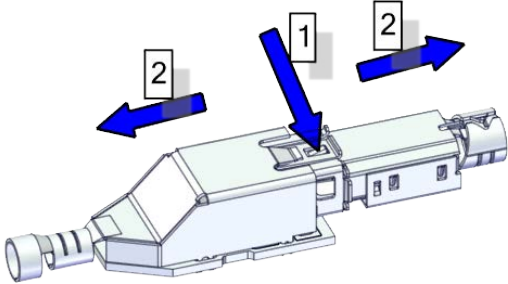
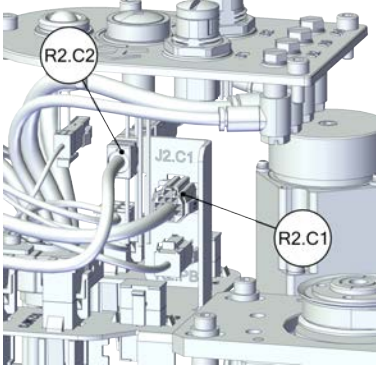
	Action	Note
3	<p>Disconnect the air hoses from the L-shaped connectors.</p>	 <p>xx2100001032</p>
4	<p>For robots with C1 cabling Disconnect the connector. • R2.C1</p>	 <p>xx2100001033</p>
5	<p>For robots with C2 cabling Disconnect the connector. • R1.C2</p> <p> Tip Cut the cable straps for the R1.C2 at the same time.</p> <p> Tip Take photos of the connector and cable position before disconnecting them, to have as a reference when reconnecting.</p> <p> Tip The connector clip has to be pressed (1) and pushed forward (2) to separate the R1.C2 (for C2 cabling).</p>  <p>xx1800002943</p>	 <p>xx2100001033</p>

Continues on next page



5 Repair

5.7.1 Replacing the axis-1 motor sub-assembly

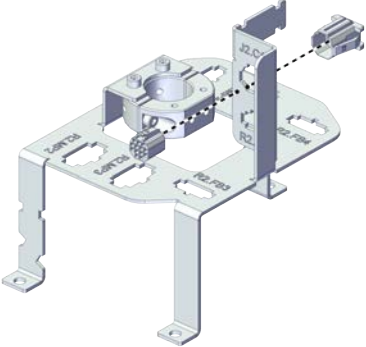
Continued

	Action	Note
6	<p>Snap loose and remove the female head of the connectors from the bracket.</p> <p> Note</p> <p>The harness are not visible due to the cleanliness requirements of the illustration. They are still existing inside the cable ferrule in the actual situation.</p>	 <p>xx2100001034</p>

Disconnecting the connectors for axis-2 motor

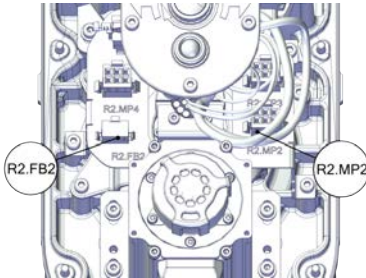

	Action	Note
1	<p> DANGER</p> <p>Make sure that all supplies for electrical power, hydraulic pressure, and air pressure are turned off.</p>	
2	<p> CAUTION</p> <p>For robots with protection type Clean Room Always cut the paint with a knife and grind the paint edge when disassembling parts of the robot! See Cut the paint or surface on the robot before replacing parts on page 118.</p>	
3	<p>Disconnect the connectors.</p> <ul style="list-style-type: none"> • R2.MP2 • R2.FB2 	 <p>xx2100000934</p>

Continues on next page

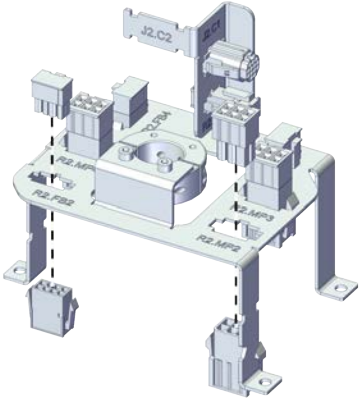
5.7.1 Replacing the axis-1 motor sub-assembly
Continued

	Action	Note
4	<p>Snap loose and remove the female head of the connectors from the bracket.</p> <p> Note</p> <p>The harness are not visible due to the cleanness requirements of the illustration. They are still existing inside the cable ferrule in the actual situation.</p>	 <p>xx2100000935</p>

Disconnecting the connectors for axis-3 motor

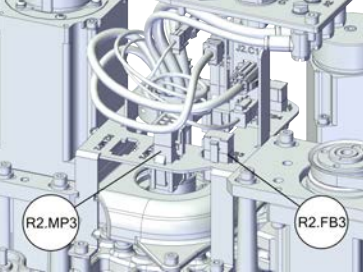
	Action	Note
1	<p> DANGER</p> <p>Make sure that all supplies for electrical power, hydraulic pressure, and air pressure are turned off.</p>	
2	<p> CAUTION</p> <p>For robots with protection type Clean Room</p> <p>Always cut the paint with a knife and grind the paint edge when disassembling parts of the robot! See Cut the paint or surface on the robot before replacing parts on page 118.</p>	
3	<p>Disconnect the connectors.</p> <ul style="list-style-type: none"> • R2.MP3 • R2.FB3 	 <p>xx2100000936</p>

Continues on next page



5 Repair

5.7.1 Replacing the axis-1 motor sub-assembly

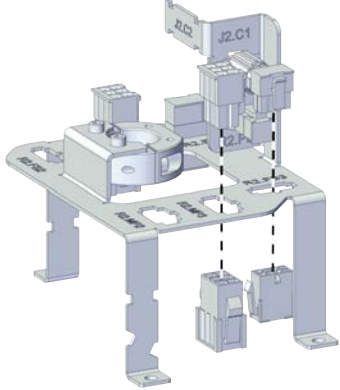
Continued



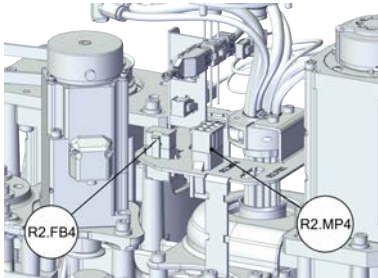

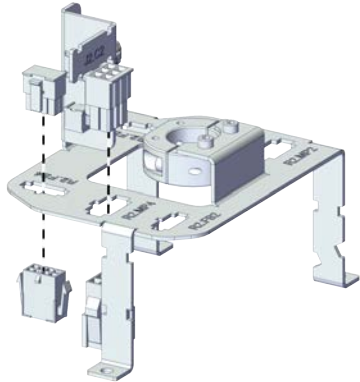
	Action	Note
4	<p>Snap loose and remove the female head of the connectors from the bracket.</p> <p> Note</p> <p>The harness are not visible due to the cleanness requirements of the illustration. They are still existing inside the cable ferrule in the actual situation.</p>	 <p>xx2100000937</p>

Disconnecting the connectors for axis-4 motor

	Action	Note
1	<p>For robots with protection type Clean Room: Clean the joints that have been opened and wipe the parts free from particles with spirit on a lint free. See Cut the paint or surface on the robot before replacing parts on page 118</p> <p> Note</p> <p>After all repair work, wipe the Clean Room robot free from particles with spirit on a lint free cloth.</p>	
2	<p>Disconnect the axis-4 motor connectors.</p> <ul style="list-style-type: none"> • R2.MP4 • R2.FB4 	 <p>xx2100000938</p>
3	<p>Snap loose and remove the female head of the connectors from the bracket.</p> <p> Note</p> <p>The harness are not visible due to the cleanness requirements of the illustration. They are still existing inside the cable ferrule in the actual situation.</p>	 <p>xx2100000939</p>

Continues on next page

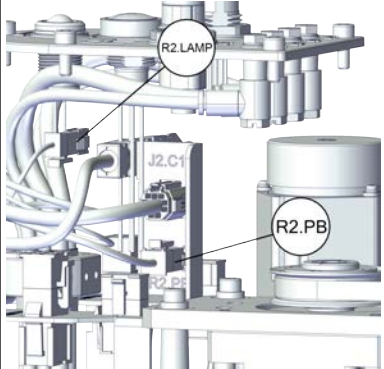
Disconnecting the connector for PB

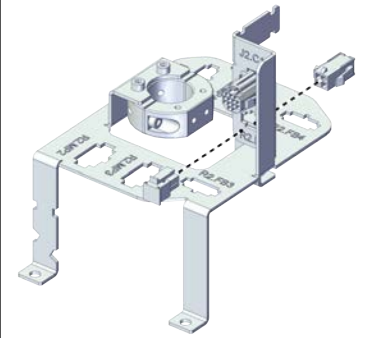
	Action	Note
1	 DANGER Make sure that all supplies for electrical power, hydraulic pressure, and air pressure are turned off.	
2	 CAUTION For robots with protection type Clean Room Always cut the paint with a knife and grind the paint edge when disassembling parts of the robot! See Cut the paint or surface on the robot before replacing parts on page 118 .	
3	Disconnect the connector. <ul style="list-style-type: none"> • R2.PB • R2.LAMP 	 <p>xx2100001030</p>
4	Snap loose and remove the female head of the connector from the bracket.  Note The harness are not visible due to the cleanliness requirements of the illustration. They are still existing inside the cable ferrule in the actual situation.	 <p>xx2100001031</p>

Pull out the process hub





	Action	Note
1	 DANGER Make sure that all supplies for electrical power, hydraulic pressure, and air pressure are turned off.	

Continues on next page



5 Repair

5.7.1 Replacing the axis-1 motor sub-assembly

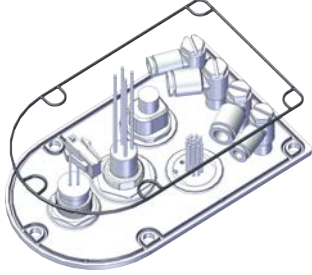
Continued



	Action	Note
2	 CAUTION For robots with protection type Clean Room Always cut the paint with a knife and grind the paint edge when disassembling parts of the robot! See Cut the paint or surface on the robot before replacing parts on page 118 .	
3	Take out the process hub.  Note For robots with protection class IP54 (option 3350-540) For robots with protection type Clean Room (option 3351-1) Check the gasket for the process hub.  Tip Replace the gasket if needed.  CAUTION Be aware of the cabling that is attached to the cover! The cover can not be removed completely until the connectors are disconnected, as shown in following steps.	For robots with protection class IP54 (option 3350-540) For robots with protection type Clean Room (option 3351-1)  xx2100002438

Removing the cable ferrule and bracket

	Action	Note
1	 DANGER Make sure that all supplies for electrical power, hydraulic pressure, and air pressure are turned off.	
2	 CAUTION For robots with protection type Clean Room Always cut the paint with a knife and grind the paint edge when disassembling parts of the robot! See Cut the paint or surface on the robot before replacing parts on page 118 .	

Continues on next page

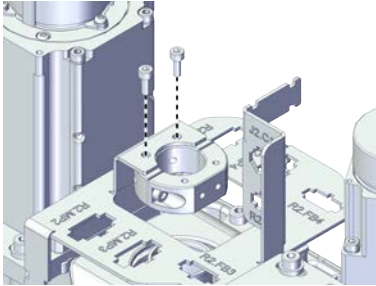
5.7.1 Replacing the axis-1 motor sub-assembly
Continued

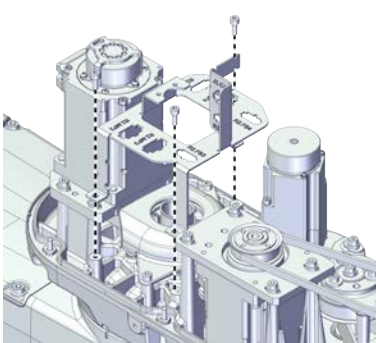
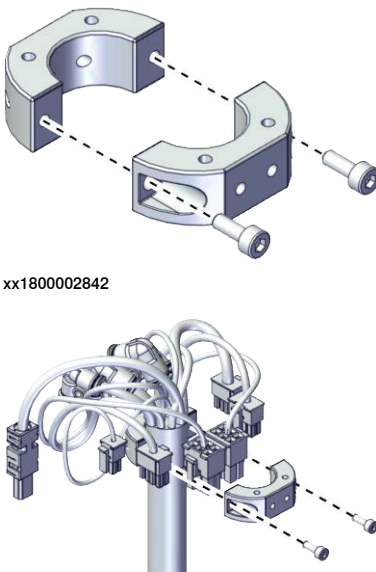
	Action	Note
3	<p>Remove the screws on the bracket to the cable ferrule to release the cable ferrule with cable.</p> <p> Note</p> <p>The harness are not visible due to the cleanness requirements of the illustration. They are still existing inside the cable ferrule in the actual situation.</p>	 <p>xx2100000940</p>
4	<p>Remove the screws on the bracket.</p> <p> Note</p> <p>The harness are not visible due to the cleanness requirements of the illustration. They are still existing inside the cable ferrule in the actual situation.</p>	 <p>xx2100000941</p>
5	<p>Remove the screws on the cable ferrule and take the cable ferrule out.</p>	 <p>xx1800002842</p> <p>xx1800002849</p>

Removing the axis-1 cover



	Action	Note
1	<p> DANGER</p> <p>Make sure that all supplies for electrical power, hydraulic pressure, and air pressure are turned off.</p>	

Continues on next page



5 Repair

5.7.1 Replacing the axis-1 motor sub-assembly

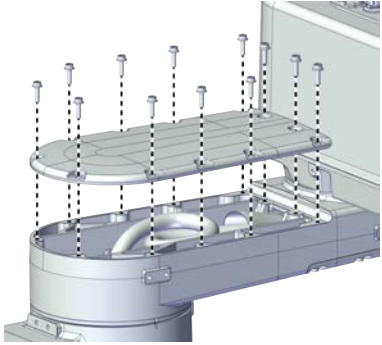
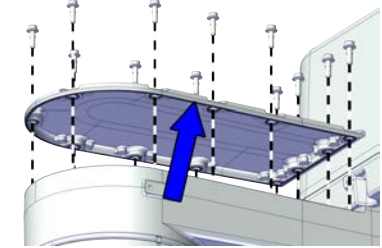
Continued



	Action	Note
2	 CAUTION For robots with protection type Clean Room Always cut the paint with a knife and grind the paint edge when disassembling parts of the robot! See Cut the paint or surface on the robot before replacing parts on page 118 .	
3	Remove the screws.	For robots with protection class IP30 (option 3350-300)
4	Remove the cover.  Note For robots with protection class IP54 (option 3350-540) For robots with protection type Clean Room (option 3351-1) Remove the cover and check the gasket.  Tip Replace the gasket if needed.	 <p>xx2100000942</p> <p>For robots with protection class IP54 (option 3350-540) For robots with protection type Clean Room (option 3351-1)</p>  <p>xx2100002428</p>

Removing the axis-2 cover



	Action	Note
1	 DANGER Make sure that all supplies for electrical power, hydraulic pressure, and air pressure are turned off.	
2	 CAUTION For robots with protection type Clean Room Always cut the paint with a knife and grind the paint edge when disassembling parts of the robot! See Cut the paint or surface on the robot before replacing parts on page 118 .	

Continues on next page

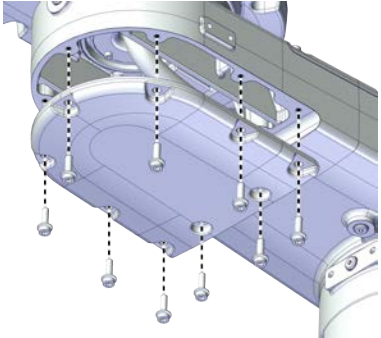
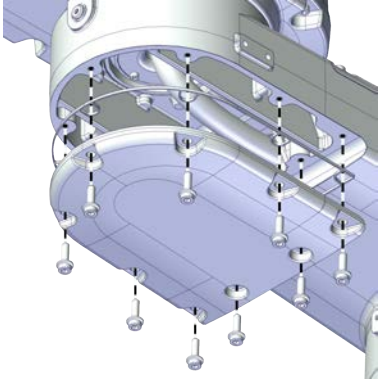
5.7.1 Replacing the axis-1 motor sub-assembly
Continued

	Action	Note
3	Remove the screws.	
4	<p>Remove the cover.</p> <p> Note</p> <p>For robots with protection class IP54 (option 3350-540)</p> <p>For robots with protection type Clean Room (option 3351-1)</p> <p>Remove the cover and check the gasket.</p> <p> Tip</p> <p>Replace the gasket if needed.</p>	<p>For robots with protection class IP30 (option 3350-300)</p>  <p>xx2100000943</p> <p>For robots with protection class IP54 (option 3350-540)</p> <p>For robots with protection type Clean Room (option 3351-1)</p>  <p>xx2100002451</p>

Removing the SMB cover





	Action	Note
1	<p> DANGER</p> <p>Make sure that all supplies for electrical power, hydraulic pressure, and air pressure are turned off.</p>	
2	<p> ELECTROSTATIC DISCHARGE (ESD)</p> <p>The unit is sensitive to ESD. Before handling the unit read the safety information in section The unit is sensitive to ESD on page 49.</p>	

Continues on next page

5 Repair

5.7.1 Replacing the axis-1 motor sub-assembly

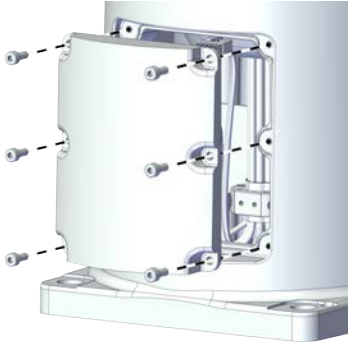
Continued

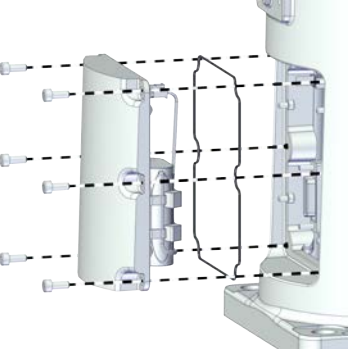

	Action	Note
3	 CAUTION For robots with protection type Clean Room Always cut the paint with a knife and grind the paint edge when disassembling parts of the robot! See Cut the paint or surface on the robot before replacing parts on page 118 .	
4	Remove the screws on the SMB cover to the base.  Note For robots with protection type Clean Room (option 3351-1) Remove the stainless screws on the SMB cover to the base.	For robots with protection class IP30 (option 3350-300) 
5	Pull the SMB cover with the SMB unit assembly out together.  Note For robots with protection class IP54 (option 3350-540) For robots with protection type Clean Room (option 3351-1) Check the gasket for the SMB cover.  Tip Replace the gasket if needed.	xx210000944 For robots with protection class IP54 (option 3350-540) For robots with protection type Clean Room (option 3351-1)  xx2100002433

Disconnecting the SMB cabling



	Action	Note
1	 DANGER Make sure that all supplies for electrical power, hydraulic pressure, and air pressure are turned off.	

Continues on next page

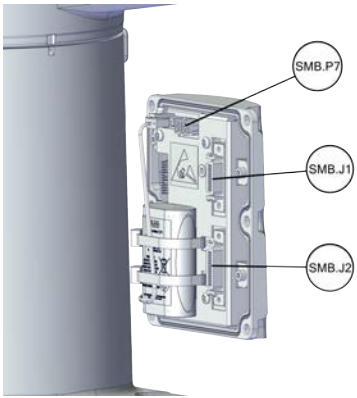
5.7.1 Replacing the axis-1 motor sub-assembly
Continued

	Action	Note
2	 ELECTROSTATIC DISCHARGE (ESD) The unit is sensitive to ESD. Before handling the unit read the safety information in section The unit is sensitive to ESD on page 49 .	
3	 CAUTION For robots with protection type Clean Room Always cut the paint with a knife and grind the paint edge when disassembling parts of the robot! See Cut the paint or surface on the robot before replacing parts on page 118 .	
4	Cut the strips.	
5	Disconnect the connectors. <ul style="list-style-type: none"> • SMB.P7 • SMB.J1 • SMB.J2  Tip Take photos of the connector and cable position before disconnecting them, to have as a reference when reconnecting.	 xx2100000945

Removing the base plate/ rear plate



	Action	Note
1	 DANGER Make sure that all supplies for electrical power, hydraulic pressure, and air pressure are turned off.	
2	 CAUTION For robots with protection type Clean Room Always cut the paint with a knife and grind the paint edge when disassembling parts of the robot! See Cut the paint or surface on the robot before replacing parts on page 118 .	
3	Remove the screws on the base to the ground.	
4	Lay down the robot.	

Continues on next page

5 Repair

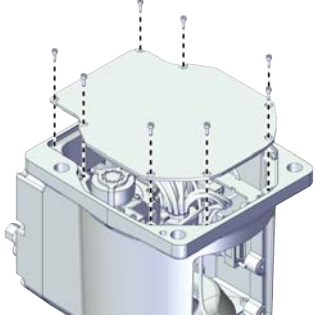
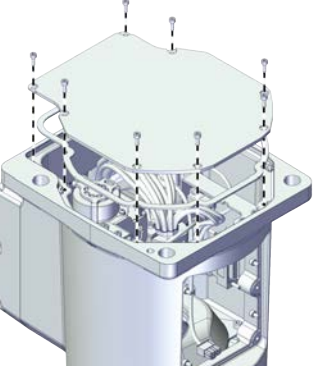

5.7.1 Replacing the axis-1 motor sub-assembly

Continued



	Action	Note
5	For robot with rear outlet cable version, remove the screws on the base plate.	For rear outlet cable version:
6	<p>Remove the base plate.</p> <p> Note</p> <p>For robots with protection class IP54 (option 3350-540)</p> <p>For robots with protection type Clean Room (option 3351-1)</p> <p>Check the gasket for the base plate.</p> <p> Tip</p> <p>Replace the gasket if needed.</p>	<p>For robots with protection class IP30 (option 3350-300)</p>  <p>xx210000946</p> <p>For robots with protection class IP54 (option 3350-540)</p> <p>For robots with protection type Clean Room (option 3351-1)</p>  <p>xx2100002434</p>

Continues on next page

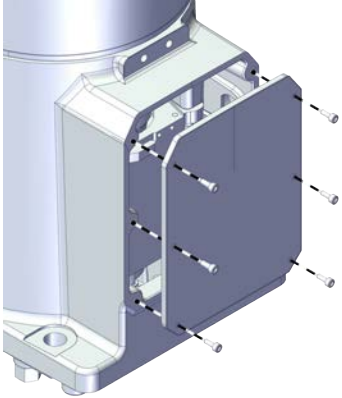
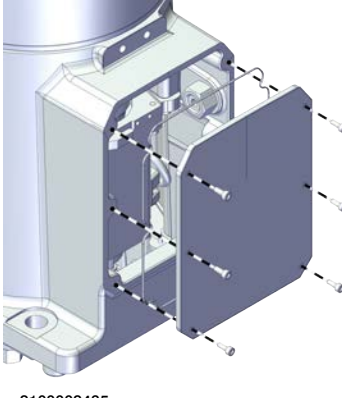
5.7.1 Replacing the axis-1 motor sub-assembly
Continued

	Action	Note
7	For robot with underneath outlet cable version, remove the screws on the rear plate.	For underneath outlet cable version:
8	<p>Remove the rear plate.</p> <p> Note</p> <p>For robots with protection class IP54 (option 3350-540)</p> <p>For robots with protection type Clean Room (option 3351-1)</p> <p>Check the gasket for the rear plate.</p> <p> Tip</p> <p>Replace the gasket if needed.</p>	<p>For robots with protection class IP30 (option 3350-300)</p>  <p>xx2100001202</p> <p>For robots with protection class IP54 (option 3350-540)</p> <p>For robots with protection type Clean Room (option 3351-1)</p>  <p>xx2100002435</p>

Releasing the base bracket

	Action	Note
1	<p> DANGER</p> <p>Make sure that all supplies for electrical power, hydraulic pressure, and air pressure are turned off.</p>	
2	<p> CAUTION</p> <p>For robots with protection type Clean Room</p> <p>Always cut the paint with a knife and grind the paint edge when disassembling parts of the robot!</p> <p>See Cut the paint or surface on the robot before replacing parts on page 118.</p>	

Continues on next page



5 Repair

5.7.1 Replacing the axis-1 motor sub-assembly

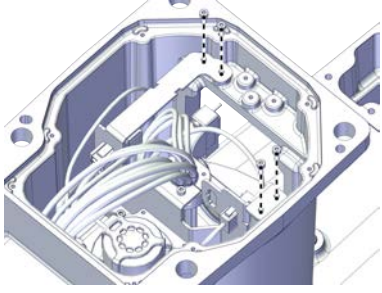
Continued

	Action	Note
3	Remove the screws on the base bracket to the base.	 <p>xx2100000948</p>

Disconnecting the grounding cable connectors

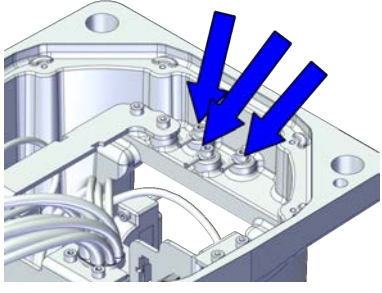

	Action	Note
1	 DANGER Make sure that all supplies for electrical power, hydraulic pressure, and air pressure are turned off.	
2	 CAUTION For robots with protection type Clean Room Always cut the paint with a knife and grind the paint edge when disassembling parts of the robot! See Cut the paint or surface on the robot before replacing parts on page 118 .	
3	Remove the three grounding cables from the bracket by unscrew the screws.	 <p>xx2100000947</p>

Disconnecting the connectors for axis-1 motor

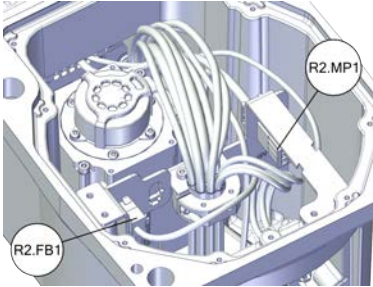

	Action	Note
1	 DANGER Make sure that all supplies for electrical power, hydraulic pressure, and air pressure are turned off.	

Continues on next page

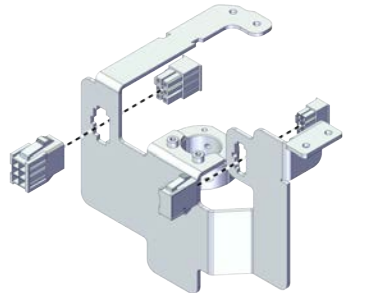
5.7.1 Replacing the axis-1 motor sub-assembly
Continued

	Action	Note
2	<p> CAUTION</p> <p>For robots with protection type Clean Room Always cut the paint with a knife and grind the paint edge when disassembling parts of the robot! See Cut the paint or surface on the robot before replacing parts on page 118.</p>	
3	<p>Disconnect the connectors.</p> <ul style="list-style-type: none"> • R2.MP1 • R2.FB1 	 <p>xx2100000949</p>
4	<p>Snap loose and remove the female head of the connectors from the bracket.</p> <p> Note</p> <p>The harness are not visible due to the cleanness requirements of the illustration. They are still existing inside the cable ferrule in the actual situation.</p>	 <p>xx2100000950</p>

Removing the bracket

	Action	Note
1	<p> DANGER</p> <p>Make sure that all supplies for electrical power, hydraulic pressure, and air pressure are turned off.</p>	
2	<p> CAUTION</p> <p>For robots with protection type Clean Room Always cut the paint with a knife and grind the paint edge when disassembling parts of the robot! See Cut the paint or surface on the robot before replacing parts on page 118.</p>	

Continues on next page



5 Repair

5.7.1 Replacing the axis-1 motor sub-assembly

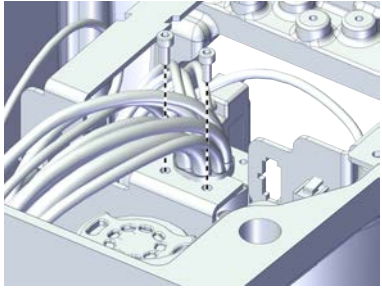
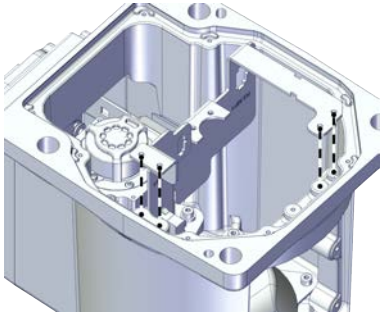
Continued



	Action	Note
3	Release the cable ferrule from the bracket.	 xx2100000951
4	Remove the bracket.	 xx2100000952

Removing the main harness from the axis -2 gearbox position



	Action	Note
1	 DANGER Make sure that all supplies for electrical power, hydraulic pressure, and air pressure are turned off.	
2	 CAUTION For robots with protection type Clean Room Always cut the paint with a knife and grind the paint edge when disassembling parts of the robot! See Cut the paint or surface on the robot before replacing parts on page 118.	

Continues on next page

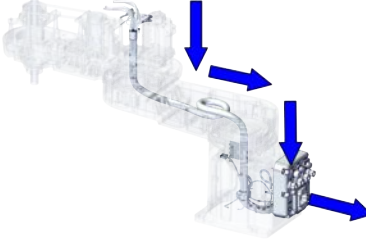
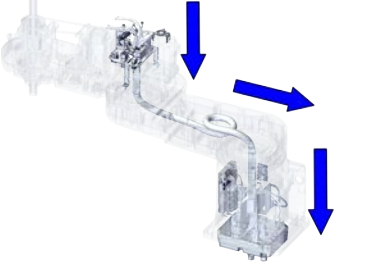
5.7.1 Replacing the axis-1 motor sub-assembly
Continued

	Action	Note
3	<p>Pull the internal harness out of the outer arm from the centre of the axis-2 gearbox.</p> <p> Tip Wrap the connectors with the masking tape.</p> <p> Tip Take photos of the connector and cable position before disconnecting them, to have as a reference when reconnecting.</p>	<p>For rear outlet cable version:</p>  <p>xx2100000954</p> <p>For underneath outlet cable version:</p>  <p>xx2100001203</p>

Removing the main harness from the axis -1 gearbox position

	Action	Note
1	<p> DANGER</p> <p>Make sure that all supplies for electrical power, hydraulic pressure, and air pressure are turned off.</p>	
2	<p> CAUTION</p> <p>For robots with protection type Clean Room Always cut the paint with a knife and grind the paint edge when disassembling parts of the robot! See Cut the paint or surface on the robot before replacing parts on page 118.</p>	

Continues on next page



5 Repair

5.7.1 Replacing the axis-1 motor sub-assembly

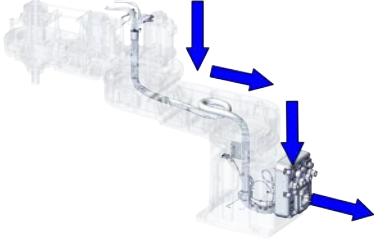
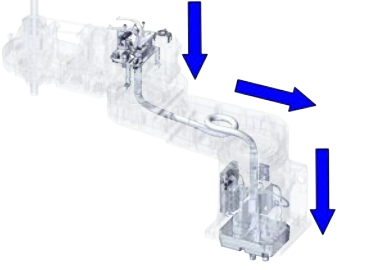
Continued



	Action	Note
3	<p>Pull the internal harness out of the inner arm from the sleeve of the axis-1 gearbox.</p> <p> Tip</p> <p>Wrap the connectors with the masking tape.</p>	<p>For rear outlet cable version:</p>  <p>xx2100000954</p> <p>For underneath outlet cable version:</p>  <p>xx2100001203</p>

Removing the main harness

	Action	Note
1	<p> DANGER</p> <p>Make sure that all supplies for electrical power, hydraulic pressure, and air pressure are turned off.</p>	
2	<p> CAUTION</p> <p>For robots with protection type Clean Room</p> <p>Always cut the paint with a knife and grind the paint edge when disassembling parts of the robot!</p> <p>See Cut the paint or surface on the robot before replacing parts on page 118.</p>	

Continues on next page

5.7.1 Replacing the axis-1 motor sub-assembly
Continued

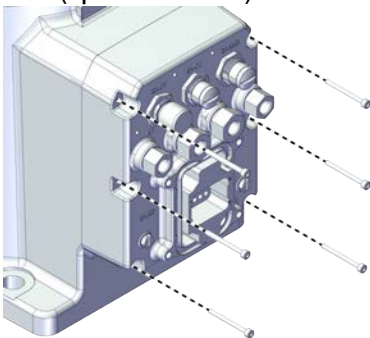
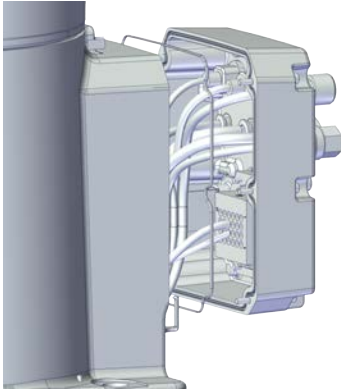

	Action	Note
3	For robot with rear outlet cable version, remove the screws on the main harness to the base.	For rear outlet cable version:
4	<p>Remove the main harness.</p> <p> Note</p> <p>For robots with protection class IP54 (option 3350-540)</p> <p>For robots with protection type Clean Room (option 3351-1)</p> <p>Check the gasket for the main harness.</p> <p> Tip</p> <p>Replace the gasket if needed.</p>	<p>For robots with protection class IP30 (option 3350-300)</p>  <p>xx2100000953</p> <p>For robots with protection class IP54 (option 3350-540)</p> <p>For robots with protection type Clean Room (option 3351-1)</p>  <p>xx2100002436</p>

Continues on next page

5 Repair

5.7.1 Replacing the axis-1 motor sub-assembly

Continued

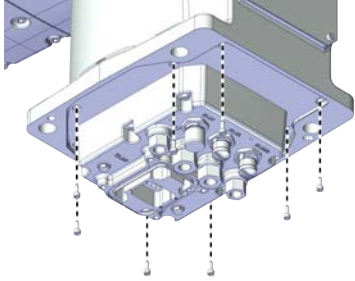
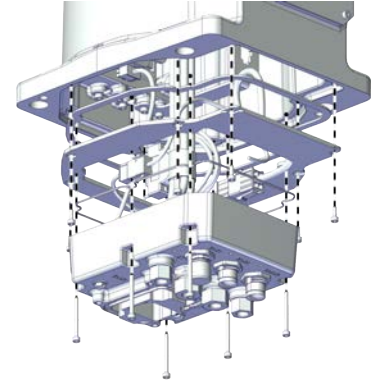
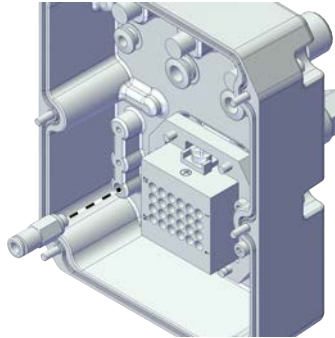
	Action	Note
5	For robot with underneath outlet cable version, remove the screws on the main harness assembly.	For underneath outlet cable version:
6	<p>Remove the main harness assembly.</p> <p> Note</p> <p>For robots with protection class IP54 (option 3350-540)</p> <p>For robots with protection type Clean Room (option 3351-1)</p> <p>Check the gasket for the main harness assembly.</p> <p> Tip</p> <p>Replace the gasket if needed.</p> <p> Note</p> <p>Remove the bottom plate from the main harness if needed.</p>	<p>For robots with protection class IP30 (option 3350-300)</p>  <p>xx2100001204</p> <p>For robots with protection class IP54 (option 3350-540)</p> <p>For robots with protection type Clean Room (option 3351-1)</p>  <p>xx2100002437</p>
7	<p>For robots with protection type Clean Room (option 3351-1)</p> <p>Remove the one way valve by unscrewing it.</p>	 <p>xx2200000281</p>

Removing the pulley protection cover



	Action	Note
1	<p> DANGER</p> <p>Make sure that all supplies for electrical power, hydraulic pressure, and air pressure are turned off.</p>	

Continues on next page

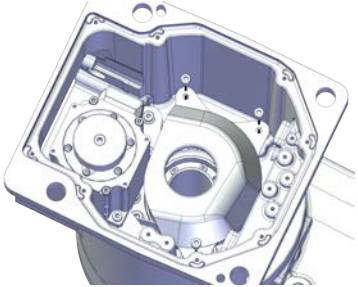
5.7.1 Replacing the axis-1 motor sub-assembly
Continued

	Action	Note
2	 CAUTION For robots with protection type Clean Room Always cut the paint with a knife and grind the paint edge when disassembling parts of the robot! See Cut the paint or surface on the robot before replacing parts on page 118 .	
3	Remove the screws on the pulley protection cover to the base.	 <p>xx2100001037</p>
4	Remove the pulley protection cover.	

Removing the axis-1 motor sub-assembly

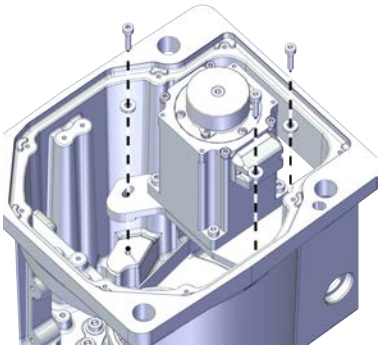
	Action	Note
1	 DANGER Make sure that all supplies for electrical power, hydraulic pressure, and air pressure are turned off.	
2	 CAUTION For robots with protection type Clean Room Always cut the paint with a knife and grind the paint edge when disassembling parts of the robot! See Cut the paint or surface on the robot before replacing parts on page 118 .	
3	Remove the screws and washers.	 <p>xx2100001038</p>
4	Remove the motor.	



Continues on next page

5 Repair

5.7.1 Replacing the axis-1 motor sub-assembly

Continued

Separating the flange from axis-1 motor sub-assembly

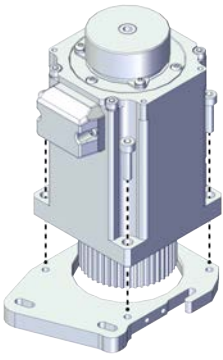
	Action	Note
1	 DANGER Make sure that all supplies for electrical power, hydraulic pressure, and air pressure are turned off.	
2	 CAUTION For robots with protection type Clean Room Always cut the paint with a knife and grind the paint edge when disassembling parts of the robot! See Cut the paint or surface on the robot before replacing parts on page 118 .	
3	Remove the screws and washers.	 xx2100001042
4	Separate the flange from the motor.	

Refitting the axis-1 motor sub-assembly

Use these procedures to refit the axis-1 motor sub-assembly.

Refitting the flange to the axis-1 motor sub-assembly

	Action	Note
1	For robots with protection type Clean Room: Clean the joints that have been opened and wipe the parts free from particles with spirit on a lint free. See Cut the paint or surface on the robot before replacing parts on page 118	
	 Note After all repair work, wipe the Clean Room robot free from particles with spirit on a lint free cloth.	

Continues on next page

5.7.1 Replacing the axis-1 motor sub-assembly
Continued

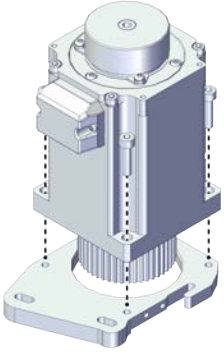
	Action	Note
2	Install the flange to the motor.	<p>Screws: Hex socket head cap screw M4x16 12.9 Lafre 2C2B/FC6.9 (4 pcs) Tightening torque: 2.3 Nm ±10%</p>  <p>xx2100001042</p>

Refitting the axis-1 motor sub-assembly

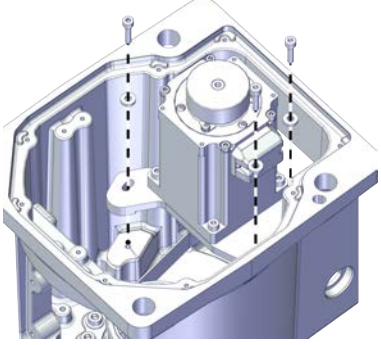
	Action	Note
1	<p>For robots with protection type Clean Room: Clean the joints that have been opened and wipe the parts free from particles with spirit on a lint free. See Cut the paint or surface on the robot before replacing parts on page 118</p> <p> Note</p> <p>After all repair work, wipe the Clean Room robot free from particles with spirit on a lint free cloth.</p>	
2	Put the timing belt into the pulley on the gear.	
3	<p>Refit the motor and refit the timing belt to the motor. Ensure that the belt runs correctly in the grooves.</p>	<p>Screws: Hex socket head cap screw M4x16 12.9 Lafre 2C2B/FC6.9 (3 pcs) Washers: Plain washer machining 4.2x9x2 steel (3 pcs) Tightening torque: 2.8 Nm ±10%</p>
4	Refit the screws and washers without fully tightened.	 <p>xx2100001038</p> <p>Timing belt A1: 3HAC070449-001</p>
5	Hang a strap to the hook on the motor.	

Continues on next page

5 Repair

5.7.1 Replacing the axis-1 motor sub-assembly

Continued

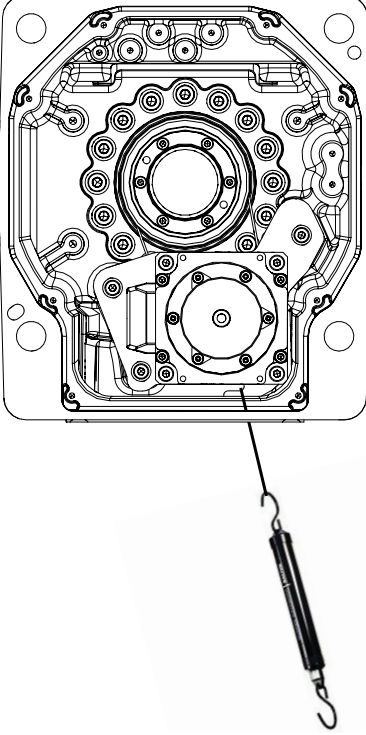
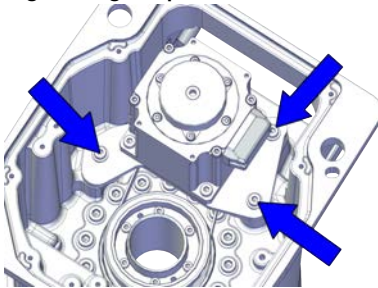
	Action	Note
6	<p>Use a handheld dynamometer hooking to the strap and pull the dynamometer to make the tension falling in the allowed force range.</p> <p> Note</p> <p>During the measurement, make sure that all interferences that may affect the force are removed. Pay attention to the force application direction.</p>	<p>Used belt: 51.1 New belt:90</p>  <p>xx2100001043</p>
7	<p>Fasten the screws to the recommended tightening torque.</p>	<p>Tightening torque: 2.8 Nm \pm10%</p>  <p>xx2100001044</p>
8	<p>Use a sonic tension meter to measure the timing belt tension.</p>	<p>Used belt: 308 New belt:250</p>
9	<p>If the timing belt tension does not meet the requirement, loosen the motor screws and readjust.</p>	

Refitting the pulley protection cover

	Action	Note
1	<p> DANGER</p> <p>Make sure that all supplies for electrical power, hydraulic pressure, and air pressure are turned off.</p>	

Continues on next page

5.7.1 Replacing the axis-1 motor sub-assembly
Continued

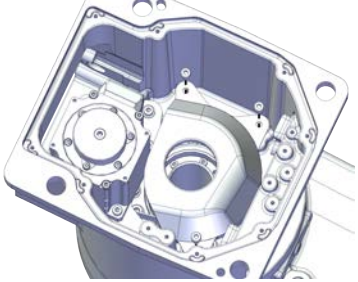
	Action	Note
2	<p> CAUTION</p> <p>For robots with protection type Clean Room Always cut the paint with a knife and grind the paint edge when disassembling parts of the robot! See Cut the paint or surface on the robot before replacing parts on page 118.</p>	
3	Refit the pulley protection cover.	<p>Screws: Hex socket head cap screw M4x10 12.9 Lafre 2C2B/FC6.9 (8 pcs) Tightening torque: 0.8 Nm</p>  <p>xx2100001037</p>
4	Secure the screws on the pulley protection cover to the base.	

Inserting the main harness through the axis -1 gearbox position





	Action	Note
1	<p>For robots with protection type Clean Room: Clean the joints that have been opened and wipe the parts free from particles with spirit on a lint free. See Cut the paint or surface on the robot before replacing parts on page 118</p> <p> Note</p> <p>After all repair work, wipe the Clean Room robot free from particles with spirit on a lint free cloth.</p>	

Continues on next page

5 Repair

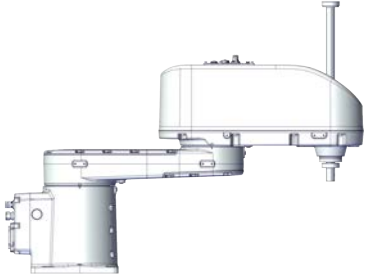
5.7.1 Replacing the axis-1 motor sub-assembly

Continued

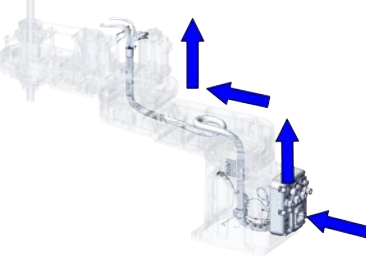
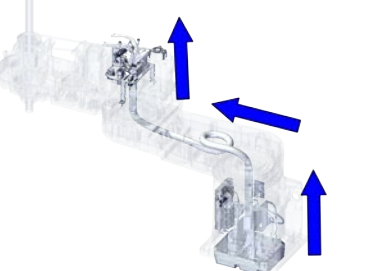
	Action	Note
2	<p>Make sure that the robot is at zero position.</p>	 <p>xx2100000930</p>
3	<p>Insert the internal harness into the inner arm through the sleeve of the axis-1 gearbox from the base.</p> <p> Tip Wrap the connectors with the masking tape.</p> <p> Tip The air hoses should face the axis-1 motor.</p> <p> CAUTION Make sure that no cables or hoses are twisted or strained. Reroute if necessary.</p>	<p>For rear outlet cable version:</p>  <p>xx2100000955</p> <p>For underneath outlet cable version:</p>  <p>xx2100001206</p>

Inserting the main harness through the axis -2 gearbox position



	Action	Note
1	<p>For robots with protection type Clean Room: Clean the joints that have been opened and wipe the parts free from particles with spirit on a lint free. See Cut the paint or surface on the robot before replacing parts on page 118</p> <p> Note After all repair work, wipe the Clean Room robot free from particles with spirit on a lint free cloth.</p>	

Continues on next page

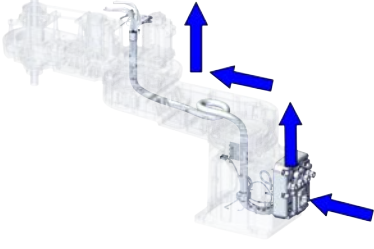
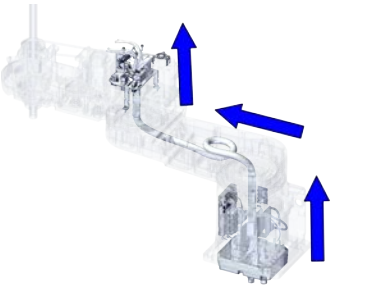
5.7.1 Replacing the axis-1 motor sub-assembly
Continued

	Action	Note
2	<p>Insert the internal harness into the outer arm through the plastic protection tube and the centre of the axis-2 gearbox.</p> <p> Tip Wrap the connectors with the masking tape.</p>	<p>For rear outlet cable version:</p>  <p>xx210000955</p> <p>For underneath outlet cable version:</p>  <p>xx2100001206</p>
3	Secure the R2.MP3 and R2.MP4 with cable straps.	

Reconnecting the connectors for axis-1 motor

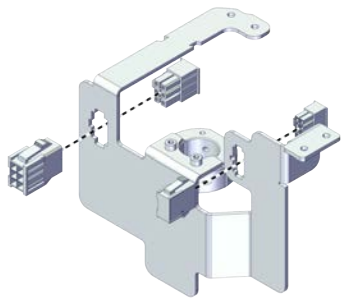

	Action	Note
1	<p>For robots with protection type Clean Room: Clean the joints that have been opened and wipe the parts free from particles with spirit on a lint free. See Cut the paint or surface on the robot before replacing parts on page 118</p> <p> Note After all repair work, wipe the Clean Room robot free from particles with spirit on a lint free cloth.</p>	
2	<p>Insert the female head of the connectors to the bracket accordingly.</p> <p> Tip The mistake proofing measure has been applied to the connectors, the connectors may be damaged if excessive force is used.</p> <p> Note The harness are not visible due to the cleanliness requirements of the illustration. They are still existing inside the cable ferrule in the actual situation.</p>	 <p>xx210000950</p>

Continues on next page

5 Repair

5.7.1 Replacing the axis-1 motor sub-assembly

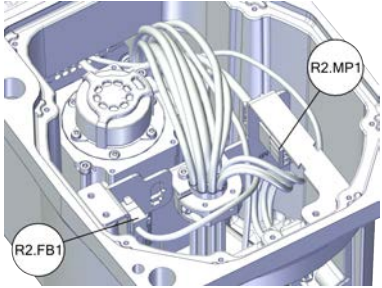
Continued

	Action	Note
3	<p>Reconnect the connectors.</p> <ul style="list-style-type: none"> • R2.MP1 • R2.FB1 <p> Tip</p> <p>See the number markings on the connectors for help to find the corresponding connector.</p>	 <p>xx2100000949</p>
4	<p>Route the cabling behind the axis-1 motor.</p> <p> CAUTION</p> <p>Correct cable routing is highly important. If the cables are routed and secured incorrectly the cables can be damaged.</p>	

Reconnecting the grounding cable connectors

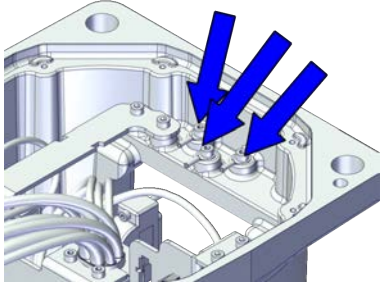



	Action	Note
1	<p>For robots with protection type Clean Room: Clean the joints that have been opened and wipe the parts free from particles with spirit on a lint free. See Cut the paint or surface on the robot before replacing parts on page 118</p> <p> Note</p> <p>After all repair work, wipe the Clean Room robot free from particles with spirit on a lint free cloth.</p>	
2	<p>Secure the three grounding cables to the bracket with the screw.</p>	<p>Screws: Hex socket head cap screw M3x5 12.9 Lafre 2C2B/FC6.9 (3 pcs) Tightening torque: 1.5 Nm \pm10%</p>  <p>xx2100000947</p>

Continues on next page

5.7.1 Replacing the axis-1 motor sub-assembly
Continued

	Action	Note
3	<p>Route and secure the cabling with cable straps if needed.</p> <p> CAUTION</p> <p>Correct cable routing is highly important. If the cables are routed and secured incorrectly the cables can be damaged.</p>	

Refitting the base bracket

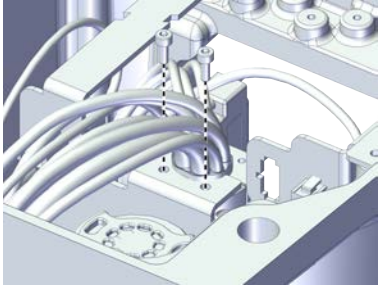
	Action	Note
1	<p> DANGER</p> <p>Make sure that all supplies for electrical power, hydraulic pressure, and air pressure are turned off.</p>	
2	<p> CAUTION</p> <p>For robots with protection type Clean Room Always cut the paint with a knife and grind the paint edge when disassembling parts of the robot! See Cut the paint or surface on the robot before replacing parts on page 118.</p>	
3	<p>Lay the main harness in a natural state without distortion.</p> <p>Secure the cable ferrule to the bracket.</p> <p> Tip</p> <p>Align all the cable ferrules so that the cable is in a natural bending position to avoid twisting.</p> <p> Note</p> <p>The harness are not visible due to the cleanness requirements of the illustration. They are still existing inside the cable ferrule in the actual situation.</p>	<p>Screws: Hex socket head cap screw M3x8 12.9 Lafre 2C2B/FC6.9 (2 pcs) Tightening torque: 1.2 Nm ±10%</p>  <p>xx2100000951</p>

Continues on next page



5 Repair

5.7.1 Replacing the axis-1 motor sub-assembly

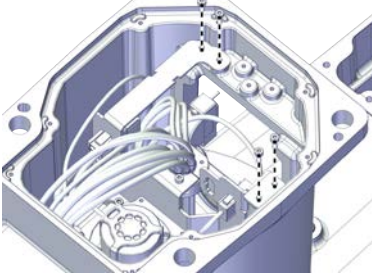
Continued

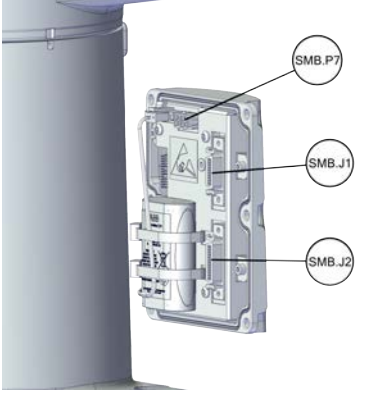

	Action	Note
4	Refit the base bracket to the base and secure with the screws.	<p>Screws: Hex socket head cap screw M3x8 12.9 Lafre 2C2B/FC6.9 (4 pcs) Tightening torque: 1.2 Nm \pm10%</p>  <p>xx210000948</p>

Refitting the SMB cover

	Action	Note
1	<p>For robots with protection type Clean Room: Clean the joints that have been opened and wipe the parts free from particles with spirit on a lint free. See Cut the paint or surface on the robot before replacing parts on page 118</p> <p> Note</p> <p>After all repair work, wipe the Clean Room robot free from particles with spirit on a lint free cloth.</p>	
2	<p>Reconnect the connectors.</p> <ul style="list-style-type: none"> • SMB.P7 • SMB.J1 • SMB.J2 <p> Tip</p> <p>Take photos of the connector and cable position before disconnecting them, to have as a reference when reconnecting.</p>	 <p>xx210000945</p>

Continues on next page

5.7.1 Replacing the axis-1 motor sub-assembly
Continued

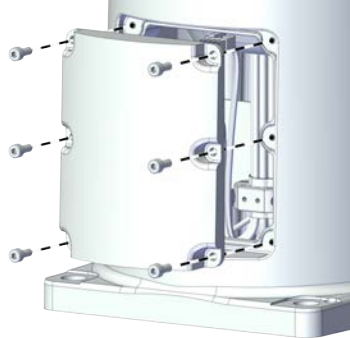
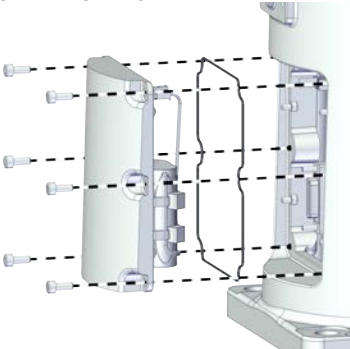
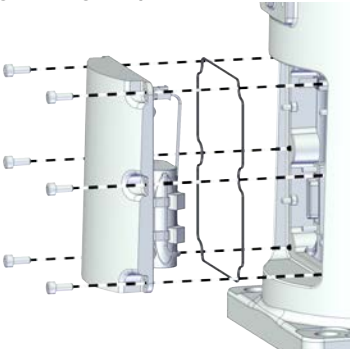
	Action	Note
3	<p>Refit the SMB cover assembly.</p> <p> Note</p> <p>For robots with protection class IP54 (option 3350-540)</p> <p>For robots with protection type Clean Room (option 3351-1)</p> <p>Check the gasket for the SMB cover.</p> <p> Tip</p> <p>Replace the gasket if needed.</p>	<p>For robots with protection class IP30 (option 3350-300)</p> <p>Screws: Hex socket head cap screw M4x10 12.9 Lafre 2C2B/FC6.9 (6 pcs)</p> <p>Tightening torque: 2.6 Nm</p> 
4	<p>Secure the SMB cover to the base with the screws.</p>	<p>xx210000944</p> <p>For robots with protection type Clean Room (option 3351-1)</p> <p>Screws: Stainless Screw Hexagon Socket Head Cap, Clean Room 3HAC075438-001 (6 pcs)</p> <p>Tightening torque: 2.6 Nm</p>  <p>xx2100002433</p> <p>For robots with protection class IP54 (option 3350-540)</p> <p>Screws: Hex socket head cap screw M4x10 12.9 Lafre 2C2B/FC6.9 (6 pcs)</p> <p>Tightening torque: 2.6 Nm</p>  <p>xx2100002433</p>

Continues on next page

5 Repair

5.7.1 Replacing the axis-1 motor sub-assembly

Continued

Refitting the main harness

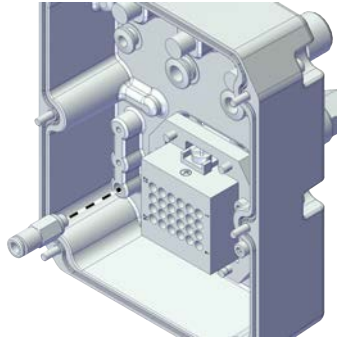
	Action	Note
1	<p>For robots with protection type Clean Room: Clean the joints that have been opened and wipe the parts free from particles with spirit on a lint free. See Cut the paint or surface on the robot before replacing parts on page 118</p> <p> Note</p> <p>After all repair work, wipe the Clean Room robot free from particles with spirit on a lint free cloth.</p>	
2	<p>For robots with protection type Clean Room (option 3351-1) Refit the one way valve by screwing it into the main harness assembly.</p>	 xx2200000281

Continues on next page

5.7.1 Replacing the axis-1 motor sub-assembly
Continued

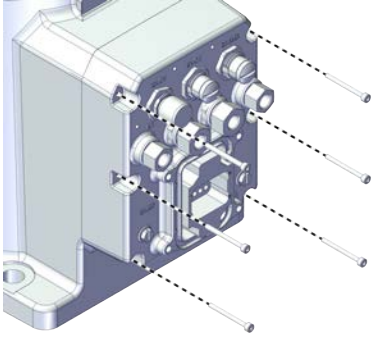
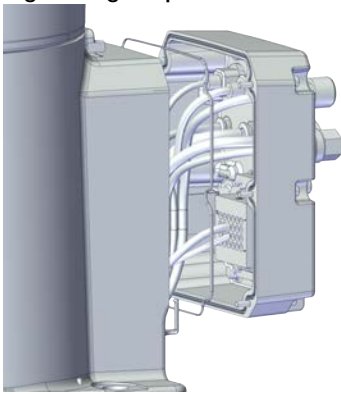
	Action	Note
3	For rear outlet cable version, refit the main harness to the base.	For rear outlet cable version:
4	Secure with the screws.	<p>For robots with protection class IP30 (option 3350-300)</p> <p>Screws: Hex socket head cap screw M3x30 12.9 Lafre 2C2B/FC6.9 (6 pcs)</p> <p>Tightening torque: 1.2 Nm ±10%</p>  <p>xx2100000953</p> <p>For robots with protection class IP54 (option 3350-540)</p> <p>For robots with protection type Clean Room (option 3351-1)</p> <p>Screws: Hex socket head cap screw M3x30 12.9 Lafre 2C2B/FC6.9 (6 pcs)</p> <p>Tightening torque: 1.2 Nm ±10%</p>  <p>xx2100002436</p>

Continues on next page

5 Repair

5.7.1 Replacing the axis-1 motor sub-assembly

Continued

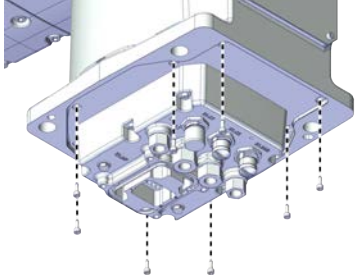
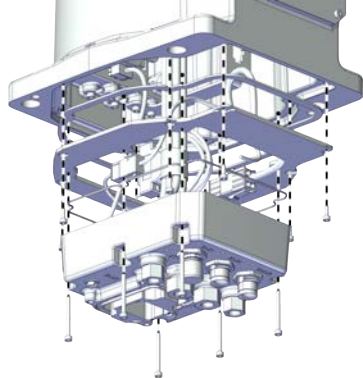
	Action	Note
5	<p>For underneath outlet cable version, refit the main harness assembly to the base.</p> <p> Note</p> <p>Refit the bottom plate to the main harness if needed.</p>	<p>For underneath outlet cable version:</p> <p>For robots with protection class IP30 (option 3350-300)</p> <p>Screws: Hex socket head cap screw M3x30 12.9 Lafre 2C2B/FC6.9 (8 pcs)</p> <p>Tightening torque: 1.2 Nm \pm10%</p>
6	Secure with the screws.	 <p>xx2100001204</p> <p>For robots with protection class IP54 (option 3350-540)</p> <p>For robots with protection type Clean Room (option 3351-1)</p> <p>Screws: Hex socket head cap screw M3x30 12.9 Lafre 2C2B/FC6.9 (8 pcs)</p> <p>Tightening torque: 1.2 Nm \pm10%</p>  <p>xx2100002437</p>

Refitting the base plate/ rear plate

	Action	Note
1	<p>For robots with protection type Clean Room:</p> <p>Clean the joints that have been opened and wipe the parts free from particles with spirit on a lint free. See Cut the paint or surface on the robot before replacing parts on page 118</p> <p> Note</p> <p>After all repair work, wipe the Clean Room robot free from particles with spirit on a lint free cloth.</p>	

Continues on next page

5.7.1 Replacing the axis-1 motor sub-assembly*Continued*





	Action	Note
2	Apply grease to the internal harness, cover all moving area of the harness.	

Continues on next page

5 Repair

5.7.1 Replacing the axis-1 motor sub-assembly

Continued

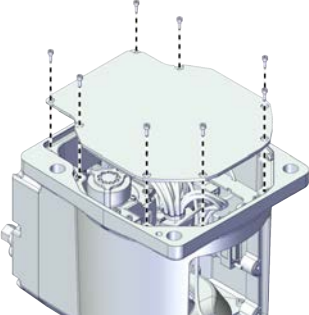
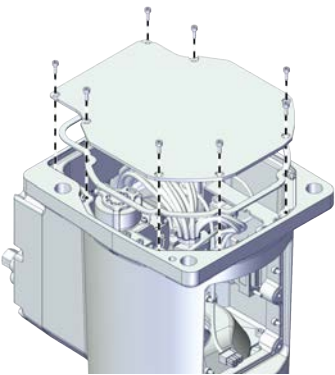
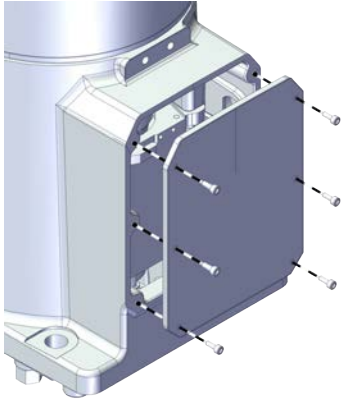
	Action	Note
3	<p>For rear outlet cable version, refit the base plate to the base.</p> <p> Note</p> <p>For robots with protection class IP54 (option 3350-540) For robots with protection type Clean Room (option 3351-1) Check the gasket for the base plate before refitting the base plate.</p> <p> Tip</p> <p>Replace the gasket if needed.</p> <p>For undeneath outlet cable version, refit the rear plate to the base.</p> <p> Note</p> <p>For robots with protection class IP54 (option 3350-540) For robots with protection type Clean Room (option 3351-1) Check the gasket for the rear plate before refitting the rear plate.</p> <p> Tip</p> <p>Replace the gasket if needed.</p>	<p>Screws: Hex socket head cap screw M3x30 12.9 Lafre 2C2B/FC6.9 (6 pcs) Tightening torque: 1.2 Nm ±10%</p> <p>For rear outlet cable version: For robots with protection class IP30 (option 3350-300)</p>  <p>xx210000946</p> <p>For robots with protection class IP54 (option 3350-540) For robots with protection type Clean Room (option 3351-1)</p>  <p>xx2100002434</p> <p>For undeneath outlet cable version: For robots with protection class IP30 (option 3350-300)</p>  <p>xx2100001202</p>
4	<p>Secure the base plate/ rear plate to the base with the screws.</p>	

Continues on next page

5.7.1 Replacing the axis-1 motor sub-assembly
Continued

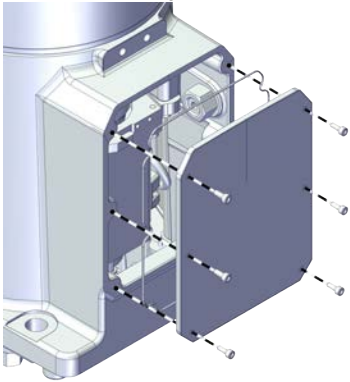
	Action	Note
		<p>For robots with protection class IP54 (option 3350-540) For robots with protection type Clean Room (option 3351-1)</p>  <p>xx2100002435</p>
5	Refit the robot back to the ground.	
6	Secure with the screws.	<p>Screws: Hex socket head cap screw M12x35 12.9 Gleitmo 603+Geomet 500 (4 pcs) Steel Washers: 24 mm x 13 mm x 2.5 mm (4 pcs) Tightening torque: 56 Nm \pm10%</p>

Refitting the cable ferrule and bracket in the outer arm







	Action	Note
1	<p>For robots with protection type Clean Room: Clean the joints that have been opened and wipe the parts free from particles with spirit on a lint free. See Cut the paint or surface on the robot before replacing parts on page 118</p> <p> Note After all repair work, wipe the Clean Room robot free from particles with spirit on a lint free cloth.</p>	
2	Lay the internal harness in a natural state without distortion.	

Continues on next page

5 Repair

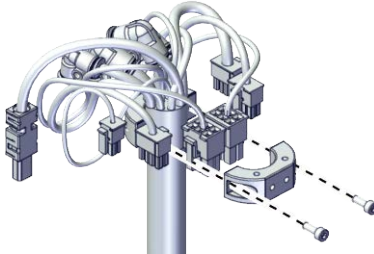

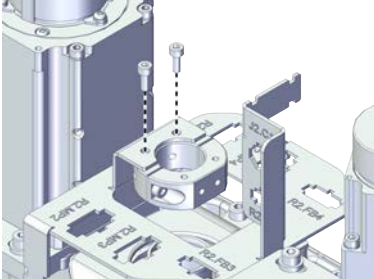



5.7.1 Replacing the axis-1 motor sub-assembly

Continued

	Action	Note
3	<p>Refit the cable ferrule and secure it with the screws.</p> <p> Tip</p> <p>The air hoses should face the process hub side.</p> <p> Tip</p> <p>The position with wrapped tape is the marked position for the cable ferrule.</p> <p> Tip</p> <p>Align all the cable ferrules so that the cable is in a natural bending position to avoid twisting.</p>	<p>Screws: Hex socket head cap screw M3x8 12.9 Lafre 2C2B/FC6.9 (2 pcs)</p> <p>Tightening torque: 1.2 Nm ±10%</p>  <p>xx1800002849</p>
4	<p>Secure the cable ferrule to the bracket.</p> <p> Tip</p> <p>Align all the cable ferrules so that the cable is in a natural bending position to avoid twisting.</p> <p> Note</p> <p>The harness are not visible due to the cleanness requirements of the illustration. They are still existing inside the cable ferrule in the actual situation.</p>	<p>Screws: Hex socket head cap screw M3x8 12.9 Lafre 2C2B/FC6.9 (2 pcs)</p> <p>Tightening torque: 1.2 Nm ±10%</p>  <p>xx2100000940</p>
5	<p>Refit the bracket without securing.</p> <p> Tip</p> <p>Do not secure it with the screws before the cable ferrule installed well.</p> <p> Note</p> <p>The harness are not visible due to the cleanness requirements of the illustration. They are still existing inside the cable ferrule in the actual situation.</p>	

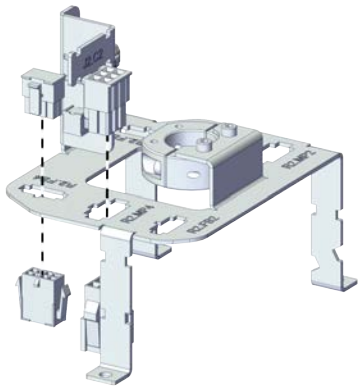
Continues on next page

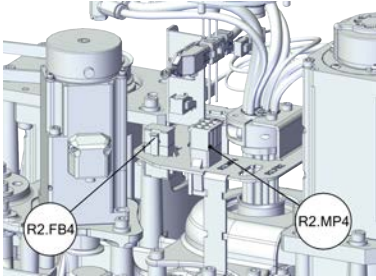
Reconnecting the connectors for axis-4 motor

	Action	Note
1	<p>For robots with protection type Clean Room: Clean the joints that have been opened and wipe the parts free from particles with spirit on a lint free. See Cut the paint or surface on the robot before replacing parts on page 118</p> <p> Note</p> <p>After all repair work, wipe the Clean Room robot free from particles with spirit on a lint free cloth.</p>	
	<p>Insert the female head of the connectors to the bracket accordingly.</p> <p> Tip</p> <p>The mistake proofing measure has been applied to the connectors, the connectors may be damaged if excessive force is used.</p> <p> Note</p> <p>The harness are not visible due to the cleanness requirements of the illustration. They are still existing inside the cable ferrule in the actual situation.</p>	 <p>xx2100000939</p>
2	<p>Reconnect the connectors.</p> <ul style="list-style-type: none"> • R2.MP4 • R2.FB4 <p> Tip</p> <p>See the number markings on the connectors for help to find the corresponding connector.</p>	 <p>xx2100000938</p>
3	<p>Route the cabling on the axis-4 motor.</p> <p> CAUTION</p> <p>Correct cable routing is highly important. If the cables are routed and secured incorrectly the cables can be damaged.</p>	







Continues on next page

5 Repair

5.7.1 Replacing the axis-1 motor sub-assembly

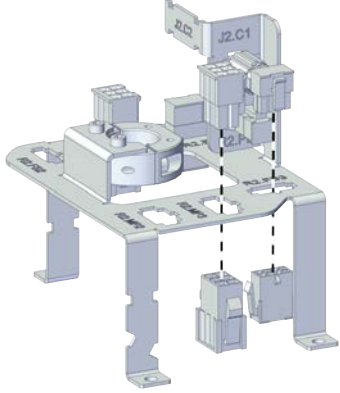

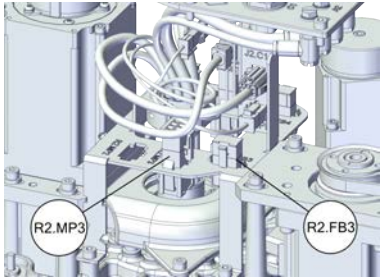



Continued

Reconnecting the connectors for axis-3 motor

	Action	Note
1	<p>For robots with protection type Clean Room: Clean the joints that have been opened and wipe the parts free from particles with spirit on a lint free. See Cut the paint or surface on the robot before replacing parts on page 118</p> <p> Note</p> <p>After all repair work, wipe the Clean Room robot free from particles with spirit on a lint free cloth.</p>	
2	<p>Insert the female head of the connectors to the bracket accordingly.</p> <p> Tip</p> <p>The mistake proofing measure has been applied to the connectors, the connectors may be damaged if excessive force is used.</p> <p> Note</p> <p>The harness are not visible due to the cleanness requirements of the illustration. They are still existing inside the cable ferrule in the actual situation.</p>	 <p>xx2100000937</p>
3	<p>Reconnect the connectors.</p> <ul style="list-style-type: none"> • R2.MP3 • R2.FB3 <p> Tip</p> <p>See the number markings on the connectors for help to find the corresponding connector.</p>	 <p>xx2100000936</p>
4	<p>Route the cabling on the axis-3 motor.</p> <p> CAUTION</p> <p>Correct cable routing is highly important. If the cables are routed and secured incorrectly the cables can be damaged.</p>	

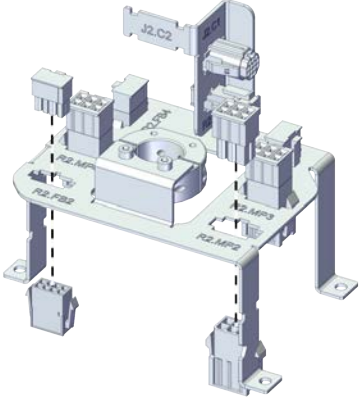
Continues on next page

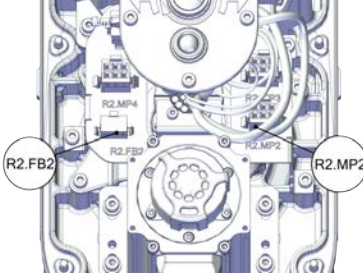
Reconnecting the connectors for axis-2 motor

	Action	Note
1	<p>For robots with protection type Clean Room: Clean the joints that have been opened and wipe the parts free from particles with spirit on a lint free. See Cut the paint or surface on the robot before replacing parts on page 118</p> <p> Note</p> <p>After all repair work, wipe the Clean Room robot free from particles with spirit on a lint free cloth.</p>	
2	<p>Insert the female head of the connectors to the bracket accordingly.</p> <p> Tip</p> <p>The mistake proofing measure has been applied to the connectors, the connectors may be damaged if excessive force is used.</p> <p> Note</p> <p>The harness are not visible due to the cleanness requirements of the illustration. They are still existing inside the cable ferrule in the actual situation.</p>	 <p>xx2100000935</p>
3	<p>Reconnect the connectors.</p> <ul style="list-style-type: none"> • R2.MP2 • R2.FB2 <p> Tip</p> <p>See the number markings on the connectors for help to find the corresponding connector.</p>	 <p>xx2100000934</p>
4	<p>Route the cabling behind the axis-2 motor.</p> <p> CAUTION</p> <p>Correct cable routing is highly important. If the cables are routed and secured incorrectly the cables can be damaged.</p>	







Continues on next page

5 Repair

5.7.1 Replacing the axis-1 motor sub-assembly

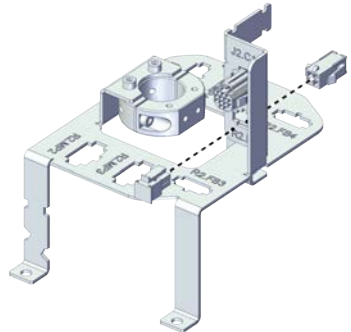

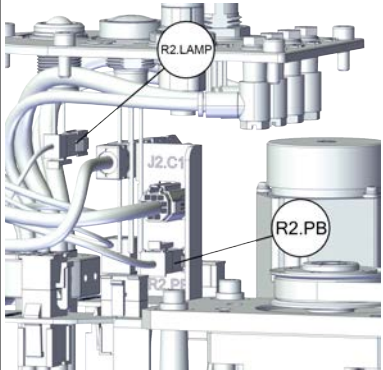
Continued

Reconnecting the connector for PB

	Action	Note
1	<p>For robots with protection type Clean Room: Clean the joints that have been opened and wipe the parts free from particles with spirit on a lint free. See Cut the paint or surface on the robot before replacing parts on page 118</p> <p> Note</p> <p>After all repair work, wipe the Clean Room robot free from particles with spirit on a lint free cloth.</p>	
2	<p>Insert the female head of the PB connector to the bracket accordingly.</p> <p> Tip</p> <p>The mistake proofing measure has been applied to the connectors, the connectors may be damaged if excessive force is used.</p> <p> Note</p> <p>The harness are not visible due to the cleanness requirements of the illustration. They are still existing inside the cable ferrule in the actual situation.</p>	 <p>xx2100001031</p>
3	<p>Reconnect the connector.</p> <ul style="list-style-type: none"> • R2.PB • R2.LAMP <p> Tip</p> <p>See the number markings on the connectors for help to find the corresponding connector.</p>	 <p>xx2100001030</p>
4	<p>Route and secure the cabling with cable straps if needed.</p> <p> CAUTION</p> <p>Correct cable routing is highly important. If the cables are routed incorrectly the cables can be damaged.</p>	

Continues on next page

Reconnecting the air hoses, CP/CS cabling and Ethernet cabling (if equipped)







	Action	Note
1	<p>For robots with protection type Clean Room: Clean the joints that have been opened and wipe the parts free from particles with spirit on a lint free. See Cut the paint or surface on the robot before replacing parts on page 118</p> <p> Note</p> <p>After all repair work, wipe the Clean Room robot free from particles with spirit on a lint free cloth.</p>	
2	<p>Route the air hoses on the process hub behind the bracket.</p> <p> CAUTION</p> <p>Correct cable routing is highly important. If the cables are routed and secured incorrectly the cables can be damaged.</p>	

Continues on next page

5 Repair

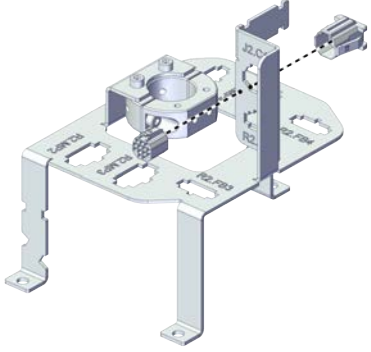
5.7.1 Replacing the axis-1 motor sub-assembly

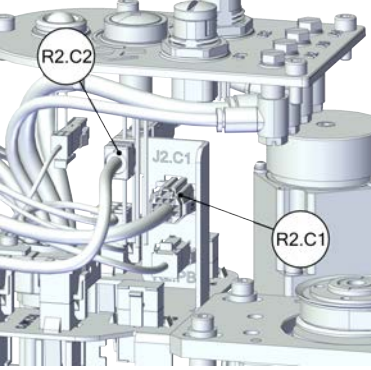

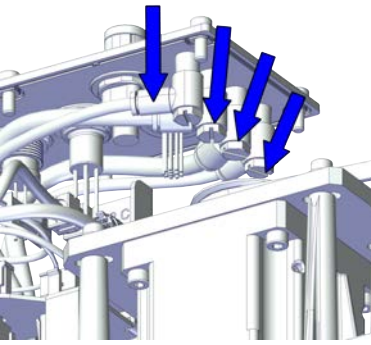
Continued

	Action	Note
3	<p>Insert the female head of the C1 cabling connector to the bracket accordingly.</p> <p> Tip</p> <p>The mistake proofing measure has been applied to the connectors, the connectors may be damaged if excessive force is used.</p> <p> Note</p> <p>The harness are not visible due to the cleanness requirements of the illustration. They are still existing inside the cable ferrule in the actual situation.</p>	 <p>xx2100001034</p>
4	<p>For robots with C1 cabling</p> <p>Reconnect the connector.</p> <ul style="list-style-type: none"> • R2.C1 <p> Tip</p> <p>See the number markings on the air hoses for help to find the corresponding air hoses.</p> <p>The air hoses with the same number connect to the same L-shaped connector.</p>	 <p>xx2100001033</p>
5	<p>For robots with C2 cabling</p> <p>Reconnect the connector.</p> <ul style="list-style-type: none"> • R1.C2 <p> Tip</p> <p>See the number markings on the air hoses for help to find the corresponding air hoses.</p> <p>The air hoses with the same number connect to the same L-shaped connector.</p>	
6	<p>Secure the C2 cabling to the C2 bracket with the cable straps.</p>	
7	<p>Reconnect the air hoses in a cross pattern with the L-shaped connectors.</p> <p> Tip</p> <p>See the number markings on the air hoses for help to find the corresponding air hoses.</p> <p>The air hoses with the same number connect to the same Y-shaped connector.</p>	 <p>xx2100001032</p>

Continues on next page

	Action	Note
8	<p>Route and secure the cabling with cable straps if needed.</p> <p> CAUTION</p> <p>Correct cable routing is highly important. If the cables are routed and secured incorrectly the cables can be damaged.</p>	

Securing the bracket in the outer arm

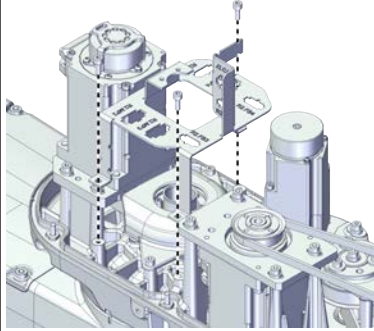
	Action	Note
1	<p>For robots with protection type Clean Room: Clean the joints that have been opened and wipe the parts free from particles with spirit on a lint free. See Cut the paint or surface on the robot before replacing parts on page 118</p> <p> Note</p> <p>After all repair work, wipe the Clean Room robot free from particles with spirit on a lint free cloth.</p>	
2	<p>Refit the bracket.</p> <p> Tip</p> <p>Do not secure it with the screws before the cable ferrule installed well.</p> <p> Note</p> <p>The harness are not visible due to the cleanness requirements of the illustration. They are still existing inside the cable ferrule in the actual situation.</p>	<p>Screws: Hex socket head cap screw M4x10 12.9 Lafre 2C2B/FC6.9 (3 pcs) Tightening torque: 1.2 Nm \pm10%</p>  <p>xx2100000941</p>

Refitting the cover of the outer arm



	Action	Note
1	<p>For robots with protection type Clean Room: Clean the joints that have been opened and wipe the parts free from particles with spirit on a lint free. See Cut the paint or surface on the robot before replacing parts on page 118</p> <p> Note</p> <p>After all repair work, wipe the Clean Room robot free from particles with spirit on a lint free cloth.</p>	

Continues on next page

5 Repair

5.7.1 Replacing the axis-1 motor sub-assembly

Continued

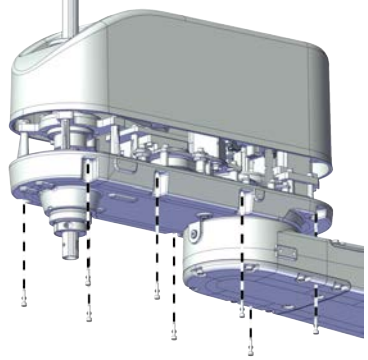
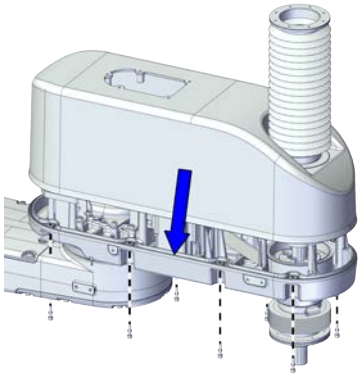
	Action	Note
2	<p>Refit the cover.</p> <p> Note</p> <p>For robots with protection class IP54 (option 3350-540)</p> <p>For robots with protection type Clean Room (option 3351-1)</p> <p>Refit the cover with bellow.</p> <p>Check the gasket for the outer arm cover.</p> <p> Tip</p> <p>Replace the gasket if needed.</p> <p> CAUTION</p> <p>The gasket is in the outer arm.</p>	<p>Screw: Hex socket head cap screw M4x16 12.9 Lafre 2C2B/FC6.9 (8 pcs)</p> <p>Tightening torque: 2 Nm \pm10%</p> <p>For robots with protection class IP30 (option 3350-300)</p>  <p>xx210000933</p>
3	<p>Refit the screws.</p>	<p>For robots with protection class IP54 (option 3350-540)</p> <p>For robots with protection type Clean Room (option 3351-1)</p>  <p>xx2100002427</p>



For Clean Room/ IP54 robots

Refitting the top cover and the flange with bearing

	Action	Note
1	<p>For robots with protection type Clean Room:</p> <p>Clean the joints that have been opened and wipe the parts free from particles with spirit on a lint free. See Cut the paint or surface on the robot before replacing parts on page 118</p> <p> Note</p> <p>After all repair work, wipe the Clean Room robot free from particles with spirit on a lint free cloth.</p>	

Continues on next page

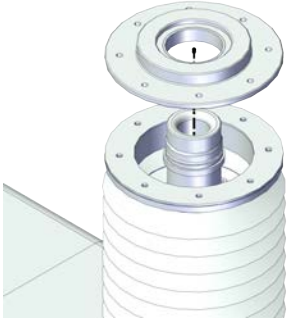
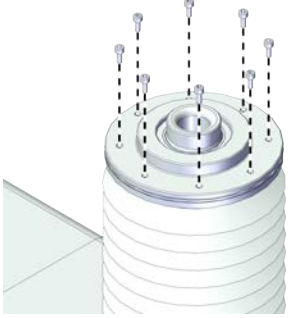
5.7.1 Replacing the axis-1 motor sub-assembly
Continued

	Action	Note
2	<p>For robots with protection class IP54 (option 3350-540) For robots with protection type Clean Room (option 3351-1) Install the flange with bearing to the extension shaft.</p>	 <p>xx2100002402</p>
3	<p>For robots with protection class IP54 (option 3350-540) For robots with protection type Clean Room (option 3351-1) Refit the screws to the flange with bearing.</p>	<p>Screws: Hex socket head cap screw M2.5x6 12.9 Lafre 2C2B/FC6.9 (8 pcs) Tightening torque: 0.8 Nm ±10%</p>  <p>xx2100002401</p>
4	<p>For robots with protection class IP54 (option 3350-540) For robots with protection type Clean Room (option 3351-1) Refit the top cover to the ball screw.</p> <p> Tip</p> <p>The top surface of the cover should be flush with the top end of the ball screw.</p>	 <p>xx2100002399</p>

Continues on next page

5 Repair

5.7.1 Replacing the axis-1 motor sub-assembly

Continued

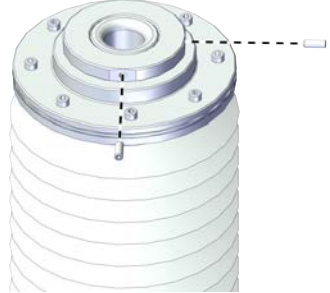

	Action	Note
5	<p>For robots with protection class IP54 (option 3350-540)</p> <p>For robots with protection type Clean Room (option 3351-1)</p> <p>Refit the locking screws.</p>	<p>Screws: Hexagon socket set screws with flat point, ISO 4026 stainless steel M3x8 (2 pcs)</p> <p>Tightening torque: 0.4 Nm \pm10%</p>  <p>xx2100002398</p>

Securing the process hub to outer arm cover

	Action	Note
1	<p>For robots with protection type Clean Room:</p> <p>Clean the joints that have been opened and wipe the parts free from particles with spirit on a lint free. See Cut the paint or surface on the robot before replacing parts on page 118</p> <p> Note</p> <p>After all repair work, wipe the Clean Room robot free from particles with spirit on a lint free cloth.</p>	
2	Insert the process hub from the outer arm cover.	

Continues on next page

5.7.1 Replacing the axis-1 motor sub-assembly
Continued

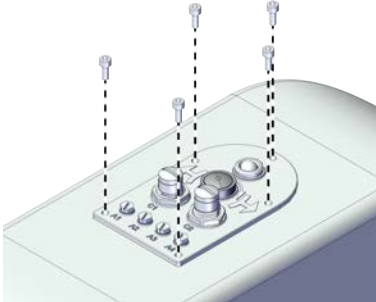
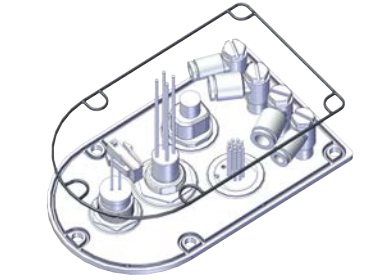
	Action	Note
3	<p>Secure the process hub to the outer arm cover with the screws.</p> <p> Note</p> <p>For robots with protection class IP54 (option 3350-540)</p> <p>For robots with protection type Clean Room (option 3351-1)</p> <p>Check the gasket for the process hub.</p> <p> Tip</p> <p>Replace the gasket if needed.</p> <p> CAUTION</p> <p>Be aware of the cabling that is attached to the cover! The cover can not be removed completely until the connectors are disconnected, as shown in following steps.</p>	<p>Screws: Hex socket head cap screw M4x10 12.9 Lafre 2C2B/FC6.9 (5 pcs)</p> <p>Tightening torque: 2.6 Nm±10%</p> <p>For robots with protection class IP30 (option 3350-300)</p>  <p>xx2100000932</p> <p>For robots with protection class IP54 (option 3350-540)</p> <p>For robots with protection type Clean Room (option 3351-1)</p>  <p>xx2100002438</p>

Refitting the axis-1 cover



	Action	Note
1	<p>For robots with protection type Clean Room:</p> <p>Clean the joints that have been opened and wipe the parts free from particles with spirit on a lint free. See Cut the paint or surface on the robot before replacing parts on page 118</p> <p> Note</p> <p>After all repair work, wipe the Clean Room robot free from particles with spirit on a lint free cloth.</p>	

Continues on next page

5 Repair

5.7.1 Replacing the axis-1 motor sub-assembly

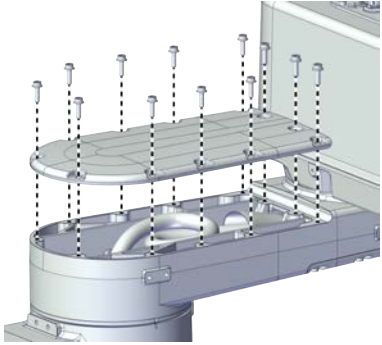
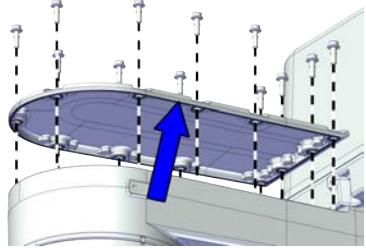

Continued

	Action	Note
2	<p>Refit the cover.</p> <p> Note</p> <p>For robots with protection class IP54 (option 3350-540)</p> <p>For robots with protection type Clean Room (option 3351-1)</p> <p>Check the gasket for the cover before refitting the cover.</p> <p> Tip</p> <p>Replace the gasket if needed.</p>	<p>For IRB 920T-6/0.45 : Screw: Hex socket head cap flange screw M5x16 12.9 Lafre 2C2B/FC6.9+PrO-COat111 (10 pcs)</p> <p>For IRB 920T-6/0.55 : Screw: Hex socket head cap flange screw M5x16 12.9 Lafre 2C2B/FC6.9+PrO-COat111 (12 pcs)</p> <p>For IRB 920T-6/0.65 : Screw: Hex socket head cap flange screw M5x16 12.9 Lafre 2C2B/FC6.9+PrO-COat111 (16 pcs)</p> <p>Tightening torque: 5.4 Nm \pm3%</p> <p>For robots with protection class IP30 (option 3350-300)</p>
3	<p>Refit the screws.</p>	 <p>xx2100000942</p> <p>For robots with protection class IP54 (option 3350-540)</p> <p>For robots with protection type Clean Room (option 3351-1)</p>  <p>xx2100002428</p>

Refitting the axis-2 cover

	Action	Note
1	<p> DANGER</p> <p>Make sure that all supplies for electrical power, hydraulic pressure, and air pressure are turned off.</p>	

Continues on next page

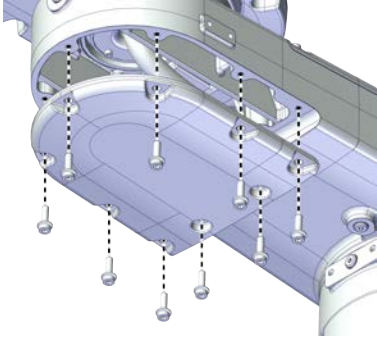
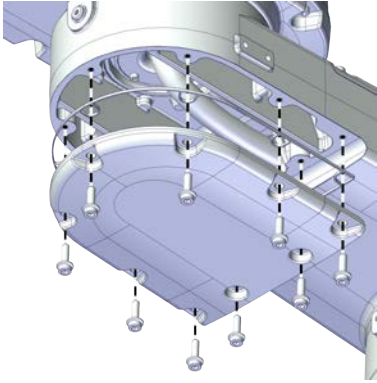
	Action	Note
2	<p> CAUTION</p> <p>For robots with protection type Clean Room Always cut the paint with a knife and grind the paint edge when disassembling parts of the robot! See <i>Cut the paint or surface on the robot before replacing parts on page 118.</i></p>	
3	<p>Refit the cover.</p> <p> Note</p> <p>For robots with protection class IP54 (option 3350-540) For robots with protection type Clean Room (option 3351-1) Check the gasket for the cover before refitting the cover.</p> <p> Tip</p> <p>Replace the gasket if needed.</p>	<p>Screws: Hex socket head cap flange screw M5x16 12.9 Lafre 2C2B/FC6.9+PrO-COat111 (9 pcs) Tightening torque: 1.2 Nm ±10%</p> <p>For robots with protection class IP30 (option 3350-300)</p>  <p>xx210000943</p>
4	<p>Refit the screws.</p>	<p>For robots with protection class IP54 (option 3350-540) For robots with protection type Clean Room (option 3351-1)</p>  <p>xx2100002451</p>



Continues on next page

5 Repair

5.7.1 Replacing the axis-1 motor sub-assembly

Continued

Concluding procedure

	Action	Note
1	<p>For robots with protection type Clean Room: Seal and paint the joints that have been opened. See Cut the paint or surface on the robot before replacing parts on page 118</p> <p> Note</p> <p>After all repair work, wipe the Clean Room robot free from particles with spirit on a lint free cloth.</p>	
2	Recalibrate the robot.	Calibration is detailed in section Calibration on page 945 .
3	<p> DANGER</p> <p>Make sure all safety requirements are met when performing the first test run.</p>	

5.7.2 Replacing the axis-2 motor sub-assembly

Location of the axis-2 motor sub-assembly

The axis-2 motor sub-assembly is located as shown in the figure.

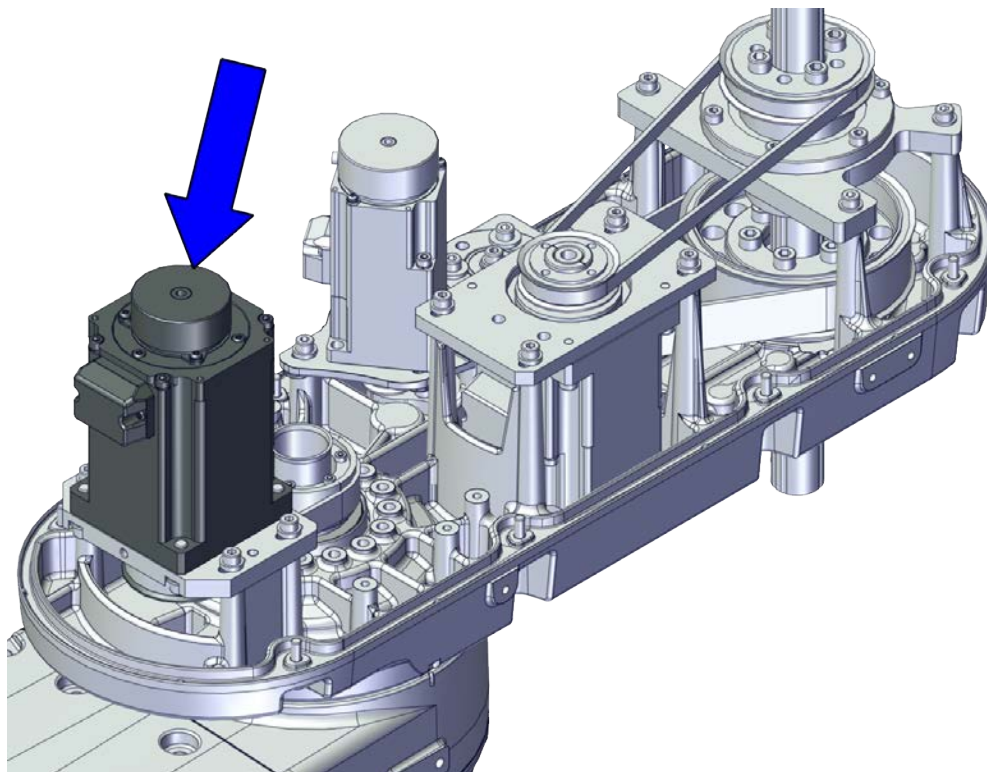

xx2100001023

Required spare parts



Note

The spare part numbers that are listed in the table can be out of date. See the latest spare parts of the IRB 920 via myABB Business Portal, www.abb.com/myABB.

Spare part	Article number	Note
Motor with pulley A2	3HAC076576-001	
Timing belt A2	3HAC061861-001	

Required tools and equipment

Equipment	Article number	Note
Standard toolkit	-	Content is defined in section Standard toolkit on page 996 .

Continues on next page

5 Repair

5.7.2 Replacing the axis-2 motor sub-assembly

Continued

Equipment	Article number	Note
Calibration toolbox, Axis Calibration	3HAC055412-001	Delivered as a set of calibration tools. Required if Axis Calibration is the valid calibration method for the robot.
Sonic tension meter	-	Used for measuring the timing belt tension.
Handheld dynamometer	-	Used for measuring the timing belt tension.

Required consumables

Consumable	Article number	Note
Cable straps	-	
Grease	3HAC029132-001	FM 222

Deciding calibration routine

Decide which calibration routine to be used, based on the information in the table. Depending on which routine is chosen, action might be required prior to beginning the repair work of the robot, see the table.



	Action	Note
1	<p>Decide which calibration routine to use for calibrating the robot.</p> <ul style="list-style-type: none"> Reference calibration. External cable packages (DressPack) and tools can stay fitted on the robot. Fine calibration. All external cable packages (DressPack) and tools must be removed from the robot. 	
	<p>If the robot is to be calibrated with reference calibration:</p> <p>Find previous reference values for the axis or create new reference values. These values are to be used after the repair procedure is completed, for calibration of the robot.</p> <p>If no previous reference values exist, and no new reference values can be created, then reference calibration is not possible.</p>	<p>Follow the instructions given in the reference calibration routine on the FlexPendant to create reference values.</p> <p>Creating new values requires possibility to move the robot.</p> <p>Read more about reference calibration for Axis Calibration in Reference calibration routine on page 957.</p>
	<p>If the robot is to be calibrated with fine calibration:</p> <p>Remove all external cable packages (DressPack) and tools from the robot.</p>	

Continues on next page

Removing the axis-2 motor sub-assembly

Use these procedures to remove the axis-2 motor sub-assembly.

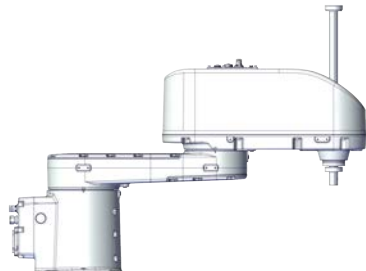
Preparations before removing the axis-2 motor sub-assembly

	Action	Note
1	Decide which calibration routine to use, and take actions accordingly prior to beginning the repair procedure.	
2	<p>If there is no enough space for the maintenance work, remove the robot from the wall and place it on the maintenance bracket.</p> <p> CAUTION</p> <p>Do not lay down the robot during the transportation, always keep it straight. If the robot lay down in any situation, the grease may come out from gearbox.</p>	
3	Jog all axes to zero position.	 <p>xx2100000930</p>
4	<p> DANGER</p> <p>Turn off all:</p> <ul style="list-style-type: none"> • electric power supply • hydraulic pressure supply • air pressure supply <p>to the robot, before entering the safeguarded space.</p>	
5	<p> CAUTION</p> <p>For robots with protection type Clean Room Always cut the paint with a knife and grind the paint edge when disassembling parts of the robot! See <i>Cut the paint or surface on the robot before replacing parts on page 118.</i></p>	





Continues on next page

5 Repair

5.7.2 Replacing the axis-2 motor sub-assembly

Continued



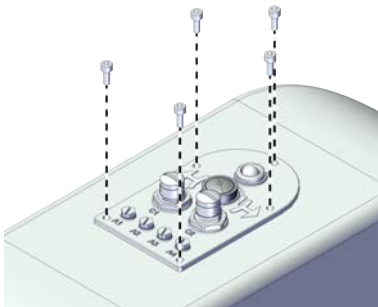
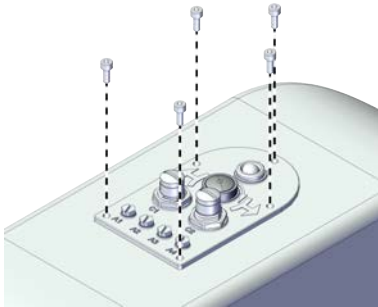

Removing the process hub screws

	Action	Note
1	 DANGER Make sure that all supplies for electrical power, hydraulic pressure, and air pressure are turned off.	
2	 CAUTION For robots with protection type Clean Room Always cut the paint with a knife and grind the paint edge when disassembling parts of the robot! See Cut the paint or surface on the robot before replacing parts on page 118 .	
3	Remove the screws on the process hub.  Note For robots with protection class IP54 (option 3350-540) For robots with protection type Clean Room (option 3351-1) Remove the screws on the process hub and take out the gasket.  Tip Check the gasket and replace it if needed.	For robots with protection class IP30  <small>xx2100000932</small> For robots with protection class IP54 (option 3350-540) For robots with protection type Clean Room (option 3351-1)  <small>xx2100000932</small>
4	Insert the process hub to the outer arm.	

Continues on next page

For Clean Room/ IP54 robots

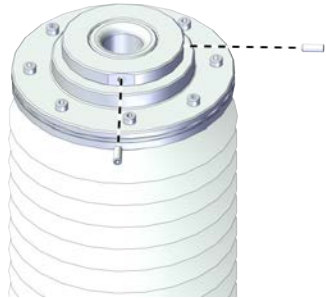
Removing the top cover and the flange with bearing

	Action	Note
1	 DANGER Make sure that all supplies for electrical power, hydraulic pressure, and air pressure are turned off.	
2	 CAUTION For robots with protection type Clean Room Always cut the paint with a knife and grind the paint edge when disassembling parts of the robot! See Cut the paint or surface on the robot before replacing parts on page 118 .	
3	For robots with protection class IP54 (option 3350-540) For robots with protection type Clean Room (option 3351-1) Loose the locking screws.	 xx2100002398
4	For robots with protection class IP54 (option 3350-540) For robots with protection type Clean Room (option 3351-1) Remove the top cover from the ball screw.	 xx2100002399

Continues on next page



5 Repair

5.7.2 Replacing the axis-2 motor sub-assembly

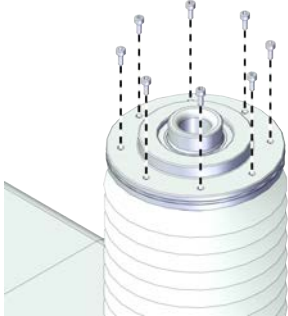
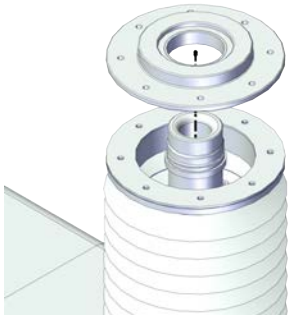
Continued



	Action	Note
5	<p>For robots with protection class IP54 (option 3350-540)</p> <p>For robots with protection type Clean Room (option 3351-1)</p> <p>Remove the screws on the flange with bearing.</p>	 <p>xx2100002401</p>
6	<p>For robots with protection class IP54 (option 3350-540)</p> <p>For robots with protection type Clean Room (option 3351-1)</p> <p>Remove the flange with bearing.</p>	 <p>xx2100002402</p>

Removing the cover of the outer arm



	Action	Note
1	 <p>DANGER</p> <p>Make sure that all supplies for electrical power, hydraulic pressure, and air pressure are turned off.</p>	
2	 <p>CAUTION</p> <p>For robots with protection type Clean Room</p> <p>Always cut the paint with a knife and grind the paint edge when disassembling parts of the robot! See Cut the paint or surface on the robot before replacing parts on page 118.</p>	

Continues on next page

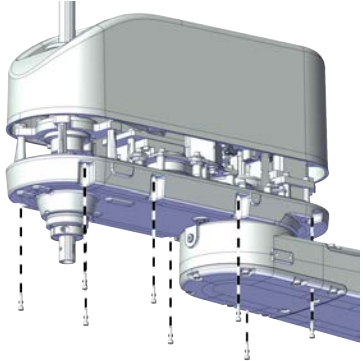
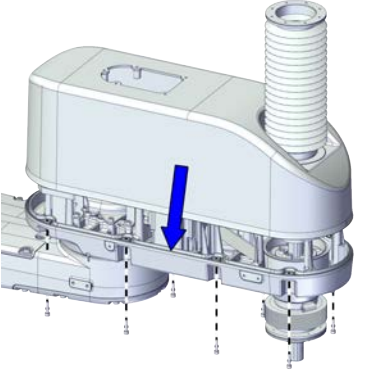
5.7.2 Replacing the axis-2 motor sub-assembly
Continued

	Action	Note
3	<p>Remove the screws on the cover of the outer arm and remove the cover.</p> <p> Note</p> <p>For robots with protection class IP54 (option 3350-540) For robots with protection type Clean Room (option 3351-1) Remove the cover with bellow and housing.</p> <p> Note</p> <p>The bellow does not need to be removed separately.</p> <p> Tip</p> <p>Check the gasket and replace it if needed.</p>	<p>For robots with protection class IP30</p>  <p>xx2100000933</p> <p>For robots with protection class IP54 (option 3350-540) For robots with protection type Clean Room (option 3351-1)</p>  <p>xx2100002427</p>

Disconnecting the air hoses, C1 cabling and C2 cabling (if equipped)





	Action	Note
1	<p> DANGER</p> <p>Make sure that all supplies for electrical power, hydraulic pressure, and air pressure are turned off.</p>	
2	<p> CAUTION</p> <p>For robots with protection type Clean Room Always cut the paint with a knife and grind the paint edge when disassembling parts of the robot! See Cut the paint or surface on the robot before replacing parts on page 118.</p>	

Continues on next page

5 Repair

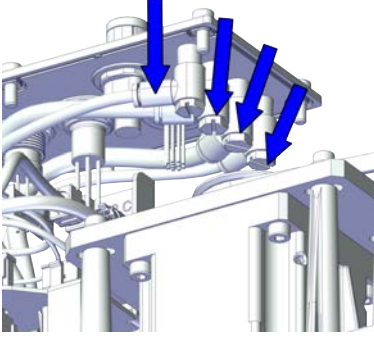
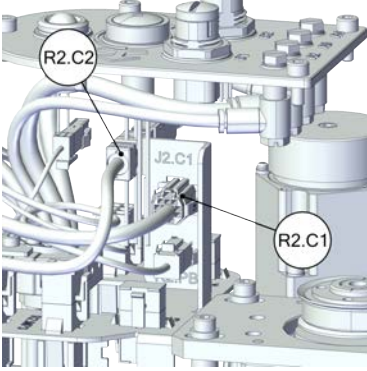
5.7.2 Replacing the axis-2 motor sub-assembly

Continued

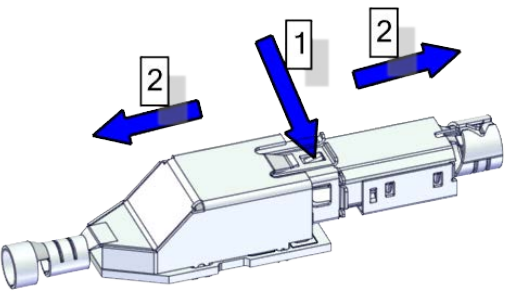
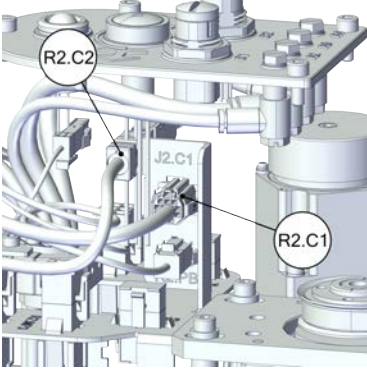

	Action	Note
3	<p>Disconnect the air hoses from the L-shaped connectors.</p>	 <p>xx2100001032</p>
4	<p>For robots with C1 cabling Disconnect the connector.</p> <ul style="list-style-type: none"> • R2.C1 	 <p>xx2100001033</p>
5	<p>For robots with C2 cabling Disconnect the connector.</p> <ul style="list-style-type: none"> • R1.C2 <p> Tip</p> <p>Cut the cable straps for the R1.C2 at the same time.</p> <p> Tip</p> <p>Take photos of the connector and cable position before disconnecting them, to have as a reference when reconnecting.</p> <p> Tip</p> <p>The connector clip has to be pressed (1) and pushed forward (2) to separate the R1.C2 (for C2 cabling).</p>  <p>xx1800002943</p>	 <p>xx2100001033</p>

Continues on next page

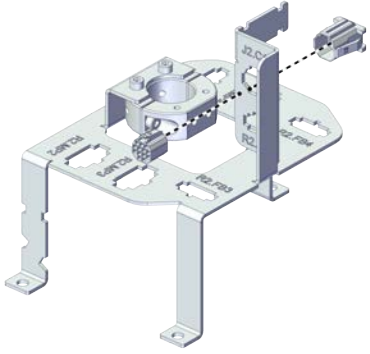
5.7.2 Replacing the axis-2 motor sub-assembly
Continued

	Action	Note
6	<p>Snap loose and remove the female head of the connectors from the bracket.</p> <p> Note</p> <p>The harness are not visible due to the cleanness requirements of the illustration. They are still existing inside the cable ferrule in the actual situation.</p>	 <p>xx2100001034</p>

Disconnecting the connectors for axis-2 motor

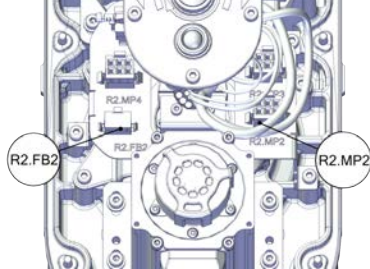
	Action	Note
1	<p> DANGER</p> <p>Make sure that all supplies for electrical power, hydraulic pressure, and air pressure are turned off.</p>	
2	<p> CAUTION</p> <p>For robots with protection type Clean Room Always cut the paint with a knife and grind the paint edge when disassembling parts of the robot! See Cut the paint or surface on the robot before replacing parts on page 118.</p>	
3	<p>Disconnect the connectors.</p> <ul style="list-style-type: none"> • R2.MP2 • R2.FB2 	 <p>xx2100000934</p>

Continues on next page



5 Repair

5.7.2 Replacing the axis-2 motor sub-assembly

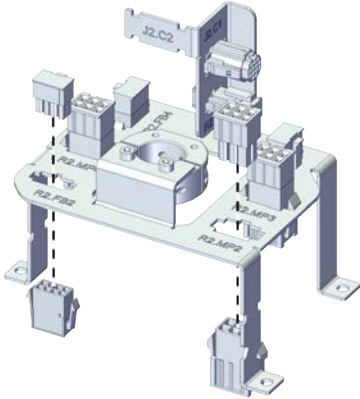
Continued

	Action	Note
4	<p>Snap loose and remove the female head of the connectors from the bracket.</p> <p> Note</p> <p>The harness are not visible due to the cleanliness requirements of the illustration. They are still existing inside the cable ferrule in the actual situation.</p>	 <p>xx2100000935</p>

Disconnecting the connectors for axis-3 motor

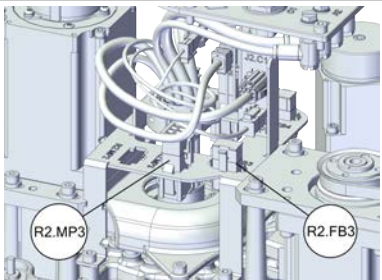

	Action	Note
1	<p> DANGER</p> <p>Make sure that all supplies for electrical power, hydraulic pressure, and air pressure are turned off.</p>	
2	<p> CAUTION</p> <p>For robots with protection type Clean Room</p> <p>Always cut the paint with a knife and grind the paint edge when disassembling parts of the robot! See Cut the paint or surface on the robot before replacing parts on page 118.</p>	
3	<p>Disconnect the connectors.</p> <ul style="list-style-type: none"> • R2.MP3 • R2.FB3 	 <p>xx2100000936</p>

Continues on next page

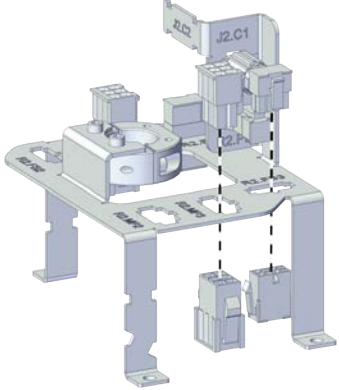
5.7.2 Replacing the axis-2 motor sub-assembly
Continued

	Action	Note
4	<p>Snap loose and remove the female head of the connectors from the bracket.</p> <p> Note</p> <p>The harness are not visible due to the cleanness requirements of the illustration. They are still existing inside the cable ferrule in the actual situation.</p>	 <p>xx2100000937</p>

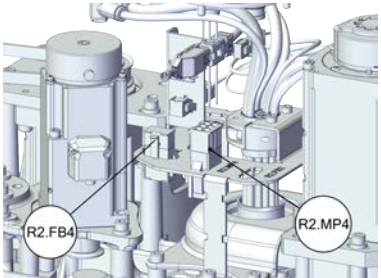
Disconnecting the connectors for axis-4 motor

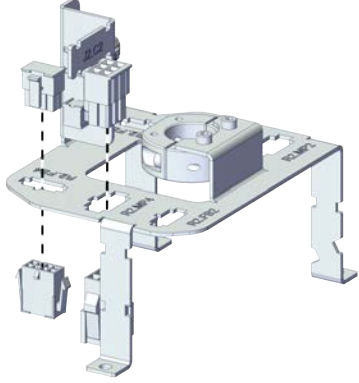
	Action	Note
1	<p>For robots with protection type Clean Room: Clean the joints that have been opened and wipe the parts free from particles with spirit on a lint free. See Cut the paint or surface on the robot before replacing parts on page 118</p> <p> Note</p> <p>After all repair work, wipe the Clean Room robot free from particles with spirit on a lint free cloth.</p>	
2	<p>Disconnect the axis-4 motor connectors.</p> <ul style="list-style-type: none"> • R2.MP4 • R2.FB4 	 <p>xx2100000938</p>
3	<p>Snap loose and remove the female head of the connectors from the bracket.</p> <p> Note</p> <p>The harness are not visible due to the cleanness requirements of the illustration. They are still existing inside the cable ferrule in the actual situation.</p>	 <p>xx2100000939</p>





Continues on next page

5 Repair

5.7.2 Replacing the axis-2 motor sub-assembly

Continued

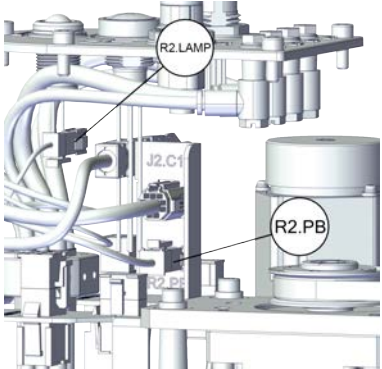
Disconnecting the connector for PB

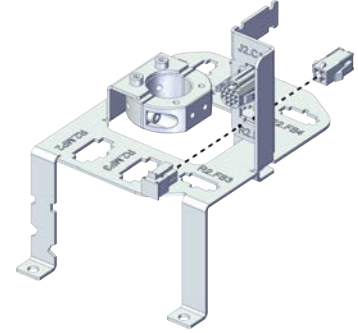



	Action	Note
1	 DANGER Make sure that all supplies for electrical power, hydraulic pressure, and air pressure are turned off.	
2	 CAUTION For robots with protection type Clean Room Always cut the paint with a knife and grind the paint edge when disassembling parts of the robot! See Cut the paint or surface on the robot before replacing parts on page 118 .	
3	Disconnect the connector. <ul style="list-style-type: none"> • R2.PB • R2.LAMP 	 <p>xx2100001030</p>
4	Snap loose and remove the female head of the connector from the bracket.  Note The harness are not visible due to the cleanliness requirements of the illustration. They are still existing inside the cable ferrule in the actual situation.	 <p>xx2100001031</p>

Pull out the process hub



	Action	Note
1	 DANGER Make sure that all supplies for electrical power, hydraulic pressure, and air pressure are turned off.	

Continues on next page

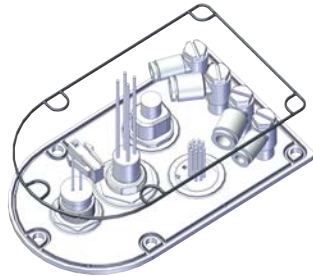
5.7.2 Replacing the axis-2 motor sub-assembly
Continued

	Action	Note
2	 CAUTION For robots with protection type Clean Room Always cut the paint with a knife and grind the paint edge when disassembling parts of the robot! See Cut the paint or surface on the robot before replacing parts on page 118 .	
3	Take out the process hub.  Note For robots with protection class IP54 (option 3350-540) For robots with protection type Clean Room (option 3351-1) Check the gasket for the process hub.  Tip Replace the gasket if needed.  CAUTION Be aware of the cabling that is attached to the cover! The cover can not be removed completely until the connectors are disconnected, as shown in following steps.	For robots with protection class IP54 (option 3350-540) For robots with protection type Clean Room (option 3351-1)  xx2100002438

Removing the cable ferrule and bracket



	Action	Note
1	 DANGER Make sure that all supplies for electrical power, hydraulic pressure, and air pressure are turned off.	
2	 CAUTION For robots with protection type Clean Room Always cut the paint with a knife and grind the paint edge when disassembling parts of the robot! See Cut the paint or surface on the robot before replacing parts on page 118 .	

Continues on next page

5 Repair

5.7.2 Replacing the axis-2 motor sub-assembly

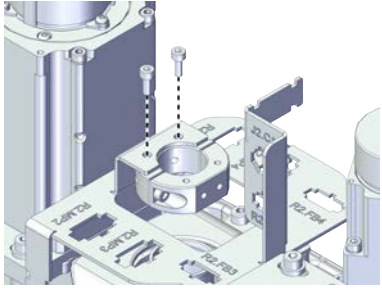
Continued

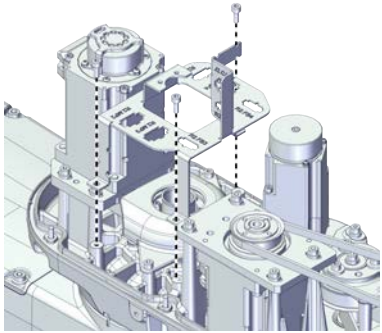
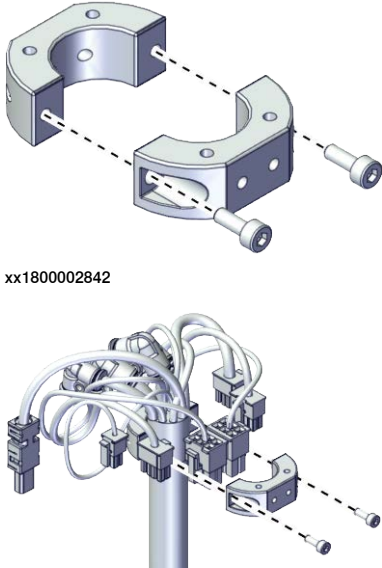
	Action	Note
3	<p>Remove the screws on the bracket to the cable ferrule to release the cable ferrule with cable.</p> <p> Note</p> <p>The harness are not visible due to the cleanness requirements of the illustration. They are still existing inside the cable ferrule in the actual situation.</p>	 <p>xx2100000940</p>
4	<p>Remove the screws on the bracket.</p> <p> Note</p> <p>The harness are not visible due to the cleanness requirements of the illustration. They are still existing inside the cable ferrule in the actual situation.</p>	 <p>xx2100000941</p>
5	<p>Remove the screws on the cable ferrule and take the cable ferrule out.</p>	 <p>xx1800002842</p> <p>xx1800002849</p>

Removing the gear-2 pulley protection cover



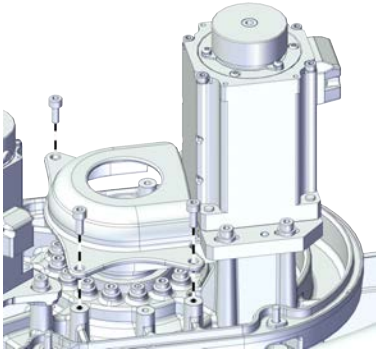

	Action	Note
1	<p> DANGER</p> <p>Make sure that all supplies for electrical power, hydraulic pressure, and air pressure are turned off.</p>	

Continues on next page

5.7.2 Replacing the axis-2 motor sub-assembly
Continued

	Action	Note
2	<p> CAUTION</p> <p>For robots with protection type Clean Room Always cut the paint with a knife and grind the paint edge when disassembling parts of the robot! See <i>Cut the paint or surface on the robot before replacing parts on page 118.</i></p>	
3	<p>Remove the screws on the pulley protection cover to release the pulley protection cover.</p>	 <p>xx2100001047</p>

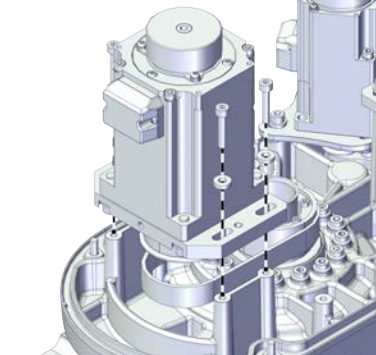
Removing the axis-2 motor sub-assembly

	Action	Note
1	<p> DANGER</p> <p>Make sure that all supplies for electrical power, hydraulic pressure, and air pressure are turned off.</p>	
2	<p> CAUTION</p> <p>For robots with protection type Clean Room Always cut the paint with a knife and grind the paint edge when disassembling parts of the robot! See <i>Cut the paint or surface on the robot before replacing parts on page 118.</i></p>	
3	<p>Remove the screws and washers.</p>	 <p>xx2100001046</p>
4	<p>Remove the motor.</p> <p> Tip</p> <p>Move the internal harness out of the way.</p>	



Continues on next page

5 Repair

5.7.2 Replacing the axis-2 motor sub-assembly

Continued

Separating the flange from axis-2 motor sub-assembly

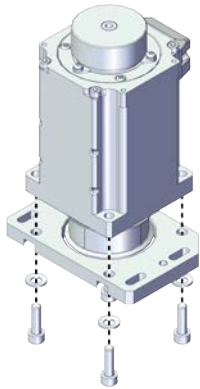
	Action	Note
1	 DANGER Make sure that all supplies for electrical power, hydraulic pressure, and air pressure are turned off.	
2	 CAUTION For robots with protection type Clean Room Always cut the paint with a knife and grind the paint edge when disassembling parts of the robot! See Cut the paint or surface on the robot before replacing parts on page 118 .	
3	Remove the screws and washers.	 xx2100001177
4	Remove the motor.	

Refitting the axis-2 motor sub-assembly

Use these procedures to refit the axis-2 motor sub-assembly.

Refitting the flange to the axis-2 motor sub-assembly

	Action	Note
1	For robots with protection type Clean Room: Clean the joints that have been opened and wipe the parts free from particles with spirit on a lint free. See Cut the paint or surface on the robot before replacing parts on page 118	
	 Note After all repair work, wipe the Clean Room robot free from particles with spirit on a lint free cloth.	

Continues on next page

5.7.2 Replacing the axis-2 motor sub-assembly
Continued

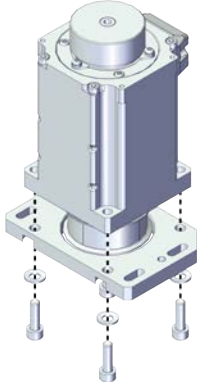
	Action	Note
2	Install the flange to the motor and secure with screws.	<p>Screws: Hex socket head cap screw M5x16 12.9 Lafre 2C2B/FC6.9 (4 pcs) Washers: Plain washer 11x5.3x1.2 Steel (4 pcs) Tightening torque: 5.7 Nm ±10%</p>  <p>xx2100001177</p>

Refitting the axis-2 motor sub-assembly

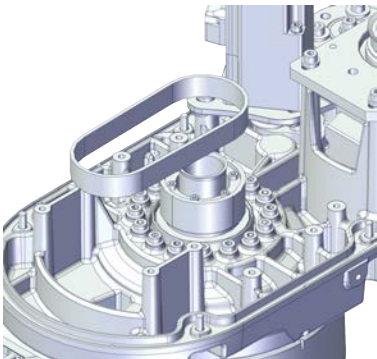

	Action	Note
1	<p>For robots with protection type Clean Room: Clean the joints that have been opened and wipe the parts free from particles with spirit on a lint free. See Cut the paint or surface on the robot before replacing parts on page 118</p> <p> Note</p> <p>After all repair work, wipe the Clean Room robot free from particles with spirit on a lint free cloth.</p>	
2	Refit the axis-2 timing belt onto the pulley on the axis-2 gearbox.	 <p>xx2100001048</p>

Continues on next page

5 Repair

5.7.2 Replacing the axis-2 motor sub-assembly

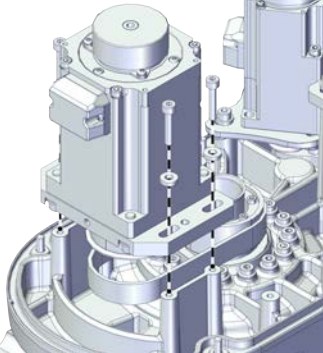
Continued

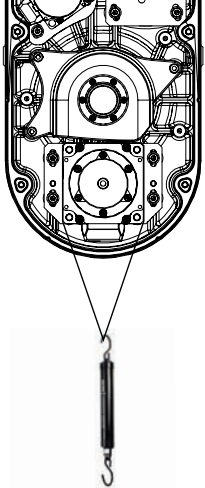
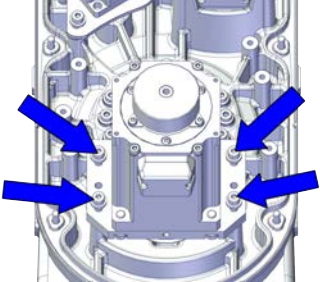

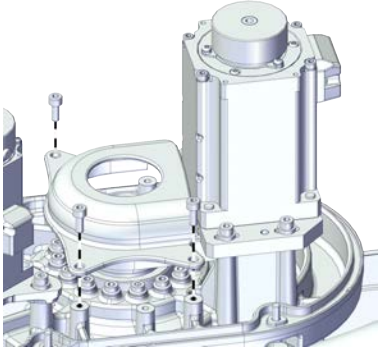

	Action	Note
3	Refit the motor and refit the timing belt to the motor. Ensure that the belt runs correctly in the grooves.	Screws: Hex socket head cap screw M4x20 12.9 Lafre 2C2B/FC6.9 (4 pcs) Washers: Plain washer machining 4.2x9x2 steel (4 pcs) Tightening torque: 2.3 Nm \pm 10%  xx2100001046 Timing belt A2: 3HAC061861-001
4	Refit the screws and washers without fully tightened.	5 Hang a strap to the motor.
6	Use a handheld dynamometer hooking to the strap and pull the dynamometer to make the tension falling in the allowed force range.  Note During the measurement, make sure that all interferences that may affect the force are removed. Pay attention to the force application direction.  Tip If the ball screw will interfere with the handheld dynamometer, adjust the ball screw manually.	Used belt: 64.7 New belt:70  xx2100001125
7	Fasten the screws to the recommended tightening torque.	Tightening torque: 2.3 Nm \pm 10%  xx2100001176

Continues on next page

5.7.2 Replacing the axis-2 motor sub-assembly
Continued

	Action	Note
8	Use a sonic tension meter to measure the timing belt tension.	Used belt: 315 New belt:260
9	If the timing belt tension does not meet the requirement, loosen the motor screws and readjust.	
10	Refit the pulley protection cover and secure with screws.	Screws: Hex socket head cap screw M4x10 12.9 Lafre 2C2B/FC6.9 (3 pcs) Tightening torque: 0.8 Nm  xx2100001047

Refitting the cable ferrule and bracket in the outer arm

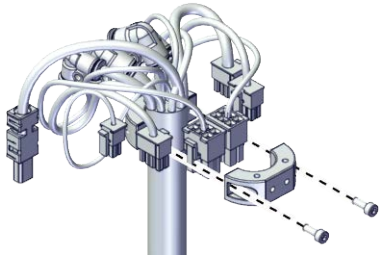



	Action	Note
1	For robots with protection type Clean Room: Clean the joints that have been opened and wipe the parts free from particles with spirit on a lint free. See Cut the paint or surface on the robot before replacing parts on page 118  Note After all repair work, wipe the Clean Room robot free from particles with spirit on a lint free cloth.	
2	Lay the internal harness in a natural state without distortion.	
3	Refit the cable ferrule and secure it with the screws.  Tip The air hoses should face the process hub side.  Tip The position with wrapped tape is the marked position for the cable ferrule.  Tip Align all the cable ferrules so that the cable is in a natural bending position to avoid twisting.	Screws: Hex socket head cap screw M3x8 12.9 Lafre 2C2B/FC6.9 (2 pcs) Tightening torque: 1.2 Nm ±10%  xx1800002849

Continues on next page

5 Repair

5.7.2 Replacing the axis-2 motor sub-assembly

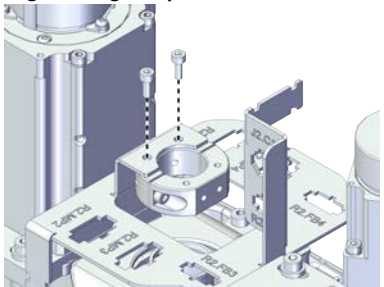
Continued







	Action	Note
4	<p>Secure the cable ferrule to the bracket.</p> <p> Tip</p> <p>Align all the cable ferrules so that the cable is in a natural bending position to avoid twisting.</p> <p> Note</p> <p>The harness are not visible due to the cleanness requirements of the illustration. They are still existing inside the cable ferrule in the actual situation.</p>	<p>Screws: Hex socket head cap screw M3x8 12.9 Lafre 2C2B/FC6.9 (2 pcs)</p> <p>Tightening torque: 1.2 Nm \pm10%</p>  <p>xx2100000940</p>
5	<p>Refit the bracket without securing.</p> <p> Tip</p> <p>Do not secure it with the screws before the cable ferrule installed well.</p> <p> Note</p> <p>The harness are not visible due to the cleanness requirements of the illustration. They are still existing inside the cable ferrule in the actual situation.</p>	

Reconnecting the connector for PB

	Action	Note
1	<p>For robots with protection type Clean Room:</p> <p>Clean the joints that have been opened and wipe the parts free from particles with spirit on a lint free. See Cut the paint or surface on the robot before replacing parts on page 118</p> <p> Note</p> <p>After all repair work, wipe the Clean Room robot free from particles with spirit on a lint free cloth.</p>	

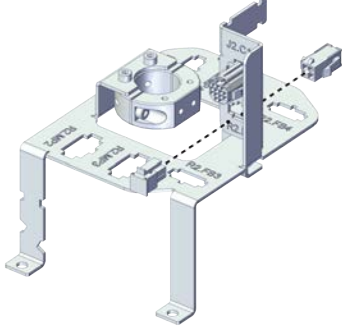
Continues on next page

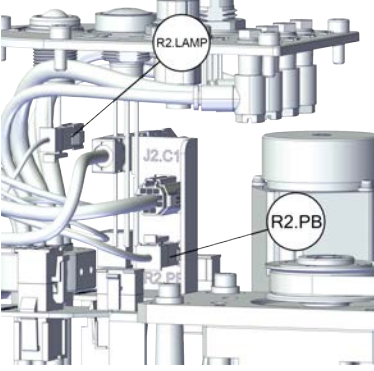
5.7.2 Replacing the axis-2 motor sub-assembly
Continued

	Action	Note
2	<p>Insert the female head of the PB connector to the bracket accordingly.</p> <p> Tip</p> <p>The mistake proofing measure has been applied to the connectors, the connectors may be damaged if excessive force is used.</p> <p> Note</p> <p>The harness are not visible due to the cleanness requirements of the illustration. They are still existing inside the cable ferrule in the actual situation.</p>	 <p>xx2100001031</p>
3	<p>Reconnect the connector.</p> <ul style="list-style-type: none"> • R2.PB • R2.LAMP <p> Tip</p> <p>See the number markings on the connectors for help to find the corresponding connector.</p>	 <p>xx2100001030</p>
4	<p>Route and secure the cabling with cable straps if needed.</p> <p> CAUTION</p> <p>Correct cable routing is highly important. If the cables are routed incorrectly the cables can be damaged.</p>	

Reconnecting the connectors for axis-4 motor







	Action	Note
1	<p>For robots with protection type Clean Room: Clean the joints that have been opened and wipe the parts free from particles with spirit on a lint free. See Cut the paint or surface on the robot before replacing parts on page 118</p> <p> Note</p> <p>After all repair work, wipe the Clean Room robot free from particles with spirit on a lint free cloth.</p>	

Continues on next page

5 Repair

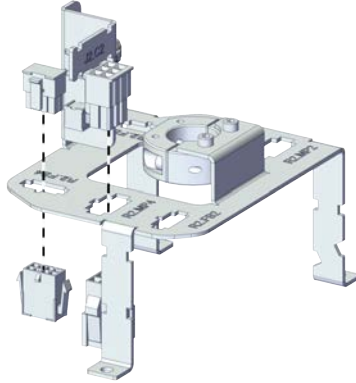
5.7.2 Replacing the axis-2 motor sub-assembly

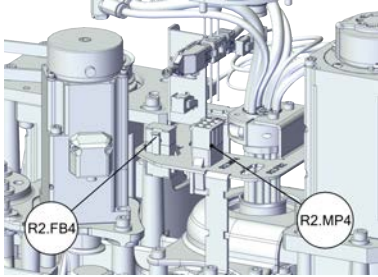
Continued







	Action	Note
	<p>Insert the female head of the connectors to the bracket accordingly.</p> <p> Tip</p> <p>The mistake proofing measure has been applied to the connectors, the connectors may be damaged if excessive force is used.</p> <p> Note</p> <p>The harness are not visible due to the cleanliness requirements of the illustration. They are still existing inside the cable ferrule in the actual situation.</p>	 <p>xx2100000939</p>
2	<p>Reconnect the connectors.</p> <ul style="list-style-type: none"> • R2.MP4 • R2.FB4 <p> Tip</p> <p>See the number markings on the connectors for help to find the corresponding connector.</p>	 <p>xx2100000938</p>
3	<p>Route the cabling on the axis-4 motor.</p> <p> CAUTION</p> <p>Correct cable routing is highly important. If the cables are routed and secured incorrectly the cables can be damaged.</p>	

Reconnecting the connectors for axis-3 motor

	Action	Note
1	<p>For robots with protection type Clean Room: Clean the joints that have been opened and wipe the parts free from particles with spirit on a lint free. See Cut the paint or surface on the robot before replacing parts on page 118</p> <p> Note</p> <p>After all repair work, wipe the Clean Room robot free from particles with spirit on a lint free cloth.</p>	

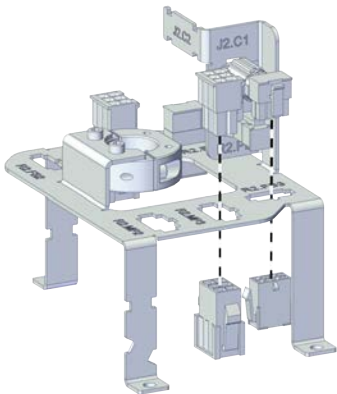
Continues on next page

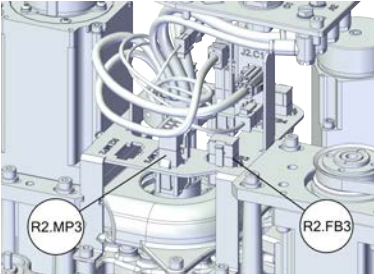
5.7.2 Replacing the axis-2 motor sub-assembly
Continued

	Action	Note
2	<p>Insert the female head of the connectors to the bracket accordingly.</p> <p> Tip</p> <p>The mistake proofing measure has been applied to the connectors, the connectors may be damaged if excessive force is used.</p> <p> Note</p> <p>The harness are not visible due to the cleanness requirements of the illustration. They are still existing inside the cable ferrule in the actual situation.</p>	 <p>xx2100000937</p>
3	<p>Reconnect the connectors.</p> <ul style="list-style-type: none"> • R2.MP3 • R2.FB3 <p> Tip</p> <p>See the number markings on the connectors for help to find the corresponding connector.</p>	 <p>xx2100000936</p>
4	<p>Route the cabling on the axis-3 motor.</p> <p> CAUTION</p> <p>Correct cable routing is highly important. If the cables are routed and secured incorrectly the cables can be damaged.</p>	

Reconnecting the connectors for axis-2 motor







	Action	Note
1	<p>For robots with protection type Clean Room: Clean the joints that have been opened and wipe the parts free from particles with spirit on a lint free. See Cut the paint or surface on the robot before replacing parts on page 118</p> <p> Note</p> <p>After all repair work, wipe the Clean Room robot free from particles with spirit on a lint free cloth.</p>	

Continues on next page

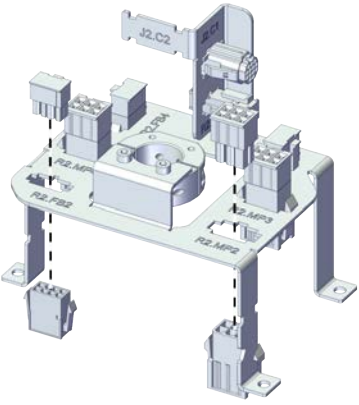

5 Repair

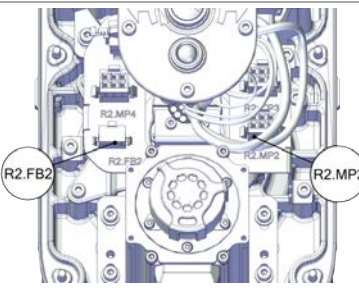
5.7.2 Replacing the axis-2 motor sub-assembly







Continued

	Action	Note
2	<p>Insert the female head of the connectors to the bracket accordingly.</p> <p> Tip</p> <p>The mistake proofing measure has been applied to the connectors, the connectors may be damaged if excessive force is used.</p> <p> Note</p> <p>The harness are not visible due to the cleanliness requirements of the illustration. They are still existing inside the cable ferrule in the actual situation.</p>	 <p>xx2100000935</p>
3	<p>Reconnect the connectors.</p> <ul style="list-style-type: none"> • R2.MP2 • R2.FB2 <p> Tip</p> <p>See the number markings on the connectors for help to find the corresponding connector.</p>	 <p>xx2100000934</p>
4	<p>Route the cabling behind the axis-2 motor.</p> <p> CAUTION</p> <p>Correct cable routing is highly important. If the cables are routed and secured incorrectly the cables can be damaged.</p>	

Reconnecting the air hoses, CP/CS cabling and Ethernet cabling (if equipped)

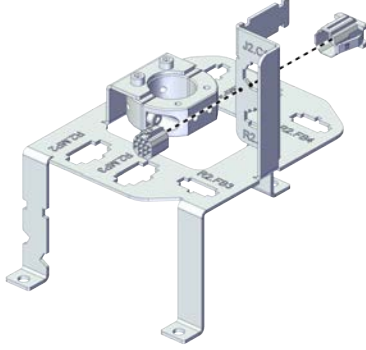
	Action	Note
1	<p>For robots with protection type Clean Room: Clean the joints that have been opened and wipe the parts free from particles with spirit on a lint free. See Cut the paint or surface on the robot before replacing parts on page 118</p> <p> Note</p> <p>After all repair work, wipe the Clean Room robot free from particles with spirit on a lint free cloth.</p>	
2	<p>Route the air hoses on the process hub behind the bracket.</p> <p> CAUTION</p> <p>Correct cable routing is highly important. If the cables are routed and secured incorrectly the cables can be damaged.</p>	

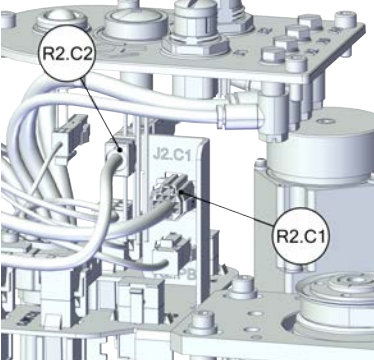
Continues on next page

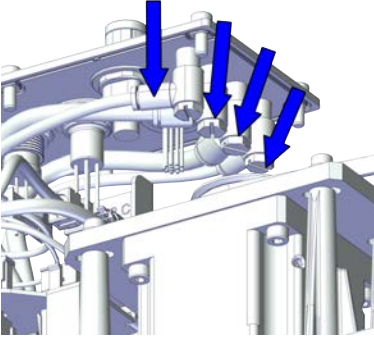
	Action	Note
3	<p>Insert the female head of the C1 cabling connector to the bracket accordingly.</p> <p> Tip</p> <p>The mistake proofing measure has been applied to the connectors, the connectors may be damaged if excessive force is used.</p> <p> Note</p> <p>The harness are not visible due to the cleanness requirements of the illustration. They are still existing inside the cable ferrule in the actual situation.</p>	 <p>xx2100001034</p>
4	<p>For robots with C1 cabling</p> <p>Reconnect the connector.</p> <ul style="list-style-type: none"> • R2.C1 <p> Tip</p> <p>See the number markings on the air hoses for help to find the corresponding air hoses.</p> <p>The air hoses with the same number connect to the same L-shaped connector.</p>	 <p>xx2100001033</p>
5	<p>For robots with C2 cabling</p> <p>Reconnect the connector.</p> <ul style="list-style-type: none"> • R1.C2 <p> Tip</p> <p>See the number markings on the air hoses for help to find the corresponding air hoses.</p> <p>The air hoses with the same number connect to the same L-shaped connector.</p>	
6	<p>Secure the C2 cabling to the C2 bracket with the cable straps.</p>	
7	<p>Reconnect the air hoses in a cross pattern with the L-shaped connectors.</p> <p> Tip</p> <p>See the number markings on the air hoses for help to find the corresponding air hoses.</p> <p>The air hoses with the same number connect to the same Y-shaped connector.</p>	 <p>xx2100001032</p>

Continues on next page



5 Repair

5.7.2 Replacing the axis-2 motor sub-assembly

Continued

	Action	Note
8	<p>Route and secure the cabling with cable straps if needed.</p> <p> CAUTION</p> <p>Correct cable routing is highly important. If the cables are routed and secured incorrectly the cables can be damaged.</p>	

Securing the bracket in the outer arm

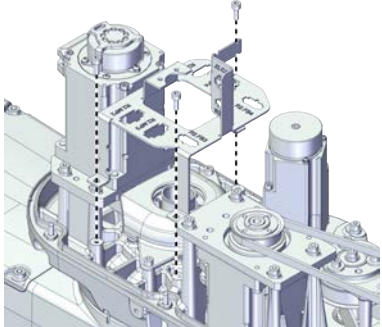

	Action	Note
1	<p>For robots with protection type Clean Room: Clean the joints that have been opened and wipe the parts free from particles with spirit on a lint free. See Cut the paint or surface on the robot before replacing parts on page 118</p> <p> Note</p> <p>After all repair work, wipe the Clean Room robot free from particles with spirit on a lint free cloth.</p>	
2	<p>Refit the bracket.</p> <p> Tip</p> <p>Do not secure it with the screws before the cable ferrule installed well.</p> <p> Note</p> <p>The harness are not visible due to the cleanness requirements of the illustration. They are still existing inside the cable ferrule in the actual situation.</p>	<p>Screws: Hex socket head cap screw M4x10 12.9 Lafre 2C2B/FC6.9 (3 pcs)</p> <p>Tightening torque: 1.2 Nm \pm10%</p>  <p>xx2100000941</p>

Refitting the cover of the outer arm

	Action	Note
1	<p>For robots with protection type Clean Room: Clean the joints that have been opened and wipe the parts free from particles with spirit on a lint free. See Cut the paint or surface on the robot before replacing parts on page 118</p> <p> Note</p> <p>After all repair work, wipe the Clean Room robot free from particles with spirit on a lint free cloth.</p>	

Continues on next page

5.7.2 Replacing the axis-2 motor sub-assembly
Continued

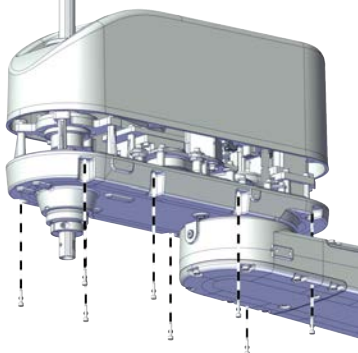
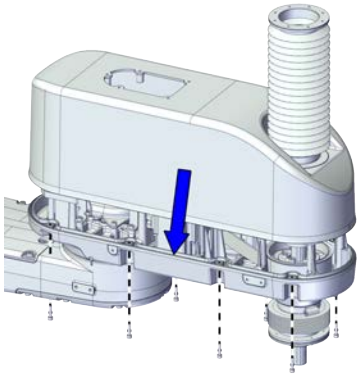
	Action	Note
2	<p>Refit the cover.</p> <p> Note</p> <p>For robots with protection class IP54 (option 3350-540)</p> <p>For robots with protection type Clean Room (option 3351-1)</p> <p>Refit the cover with bellow.</p> <p>Check the gasket for the outer arm cover.</p> <p> Tip</p> <p>Replace the gasket if needed.</p> <p> CAUTION</p> <p>The gasket is in the outer arm.</p>	<p>Screw: Hex socket head cap screw M4x16 12.9 Lafre 2C2B/FC6.9 (8 pcs)</p> <p>Tightening torque: 2 Nm ±10%</p> <p>For robots with protection class IP30 (option 3350-300)</p>  <p>xx210000933</p>
3	<p>Refit the screws.</p>	<p>For robots with protection class IP54 (option 3350-540)</p> <p>For robots with protection type Clean Room (option 3351-1)</p>  <p>xx2100002427</p>

For Clean Room/ IP54 robots

Refitting the top cover and the flange with bearing



	Action	Note
1	<p>For robots with protection type Clean Room:</p> <p>Clean the joints that have been opened and wipe the parts free from particles with spirit on a lint free. See Cut the paint or surface on the robot before replacing parts on page 118</p> <p> Note</p> <p>After all repair work, wipe the Clean Room robot free from particles with spirit on a lint free cloth.</p>	

Continues on next page

5 Repair

5.7.2 Replacing the axis-2 motor sub-assembly

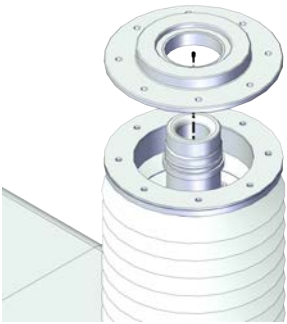
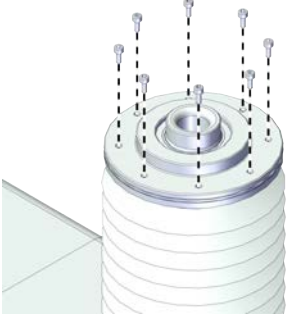
Continued

	Action	Note
2	<p>For robots with protection class IP54 (option 3350-540) For robots with protection type Clean Room (option 3351-1) Install the flange with bearing to the extension shaft.</p>	 <p>xx2100002402</p>
3	<p>For robots with protection class IP54 (option 3350-540) For robots with protection type Clean Room (option 3351-1) Refit the screws to the flange with bearing.</p>	<p>Screws: Hex socket head cap screw M2.5x6 12.9 Lafre 2C2B/FC6.9 (8 pcs) Tightening torque: 0.8 Nm \pm10%</p>  <p>xx2100002401</p>
4	<p>For robots with protection class IP54 (option 3350-540) For robots with protection type Clean Room (option 3351-1) Refit the top cover to the ball screw.</p> <p> Tip</p> <p>The top surface of the cover should be flush with the top end of the ball screw.</p>	 <p>xx2100002399</p>

Continues on next page

5.7.2 Replacing the axis-2 motor sub-assembly
Continued

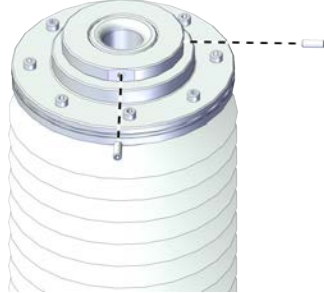
	Action	Note
5	<p>For robots with protection class IP54 (option 3350-540) For robots with protection type Clean Room (option 3351-1) Refit the locking screws.</p>	<p>Screws: Hexagon socket set screws with flat point, ISO 4026 stainless steel M3x8 (2 pcs) Tightening torque: 0.4 Nm ±10%</p>  <p>xx2100002398</p>

Securing the process hub to outer arm cover



	Action	Note
1	<p>For robots with protection type Clean Room: Clean the joints that have been opened and wipe the parts free from particles with spirit on a lint free. See Cut the paint or surface on the robot before replacing parts on page 118</p> <p> Note</p> <p>After all repair work, wipe the Clean Room robot free from particles with spirit on a lint free cloth.</p>	
2	Insert the process hub from the outer arm cover.	

Continues on next page

5 Repair

5.7.2 Replacing the axis-2 motor sub-assembly

Continued

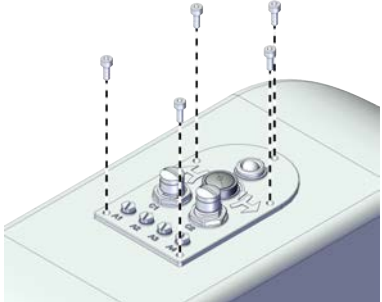
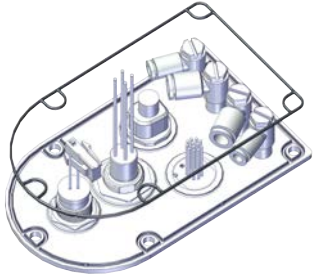
	Action	Note
3	<p>Secure the process hub to the outer arm cover with the screws.</p> <p> Note</p> <p>For robots with protection class IP54 (option 3350-540)</p> <p>For robots with protection type Clean Room (option 3351-1)</p> <p>Check the gasket for the process hub.</p> <p> Tip</p> <p>Replace the gasket if needed.</p> <p> CAUTION</p> <p>Be aware of the cabling that is attached to the cover! The cover can not be removed completely until the connectors are disconnected, as shown in following steps.</p>	<p>Screws: Hex socket head cap screw M4x10 12.9 Lafre 2C2B/FC6.9 (5 pcs)</p> <p>Tightening torque: 2.6 Nm±10%</p> <p>For robots with protection class IP30 (option 3350-300)</p>  <p>xx2100000932</p> <p>For robots with protection class IP54 (option 3350-540)</p> <p>For robots with protection type Clean Room (option 3351-1)</p>  <p>xx2100002438</p>

Concluding procedure

	Action	Note
1	<p>For robots with protection type Clean Room: Seal and paint the joints that have been opened. See Cut the paint or surface on the robot before replacing parts on page 118</p> <p> Note</p> <p>After all repair work, wipe the Clean Room robot free from particles with spirit on a lint free cloth.</p>	
2	Recalibrate the robot.	Calibration is detailed in section Calibration on page 945 .

Continues on next page

	Action	Note
3	 DANGER Make sure all safety requirements are met when performing the first test run.	

5 Repair

5.7.3 Replacing the axis-3 motor sub-assembly

5.7.3 Replacing the axis-3 motor sub-assembly

Location of the axis-3 motor sub-assembly

The axis-3 motor sub-assembly is located as shown in the figure.

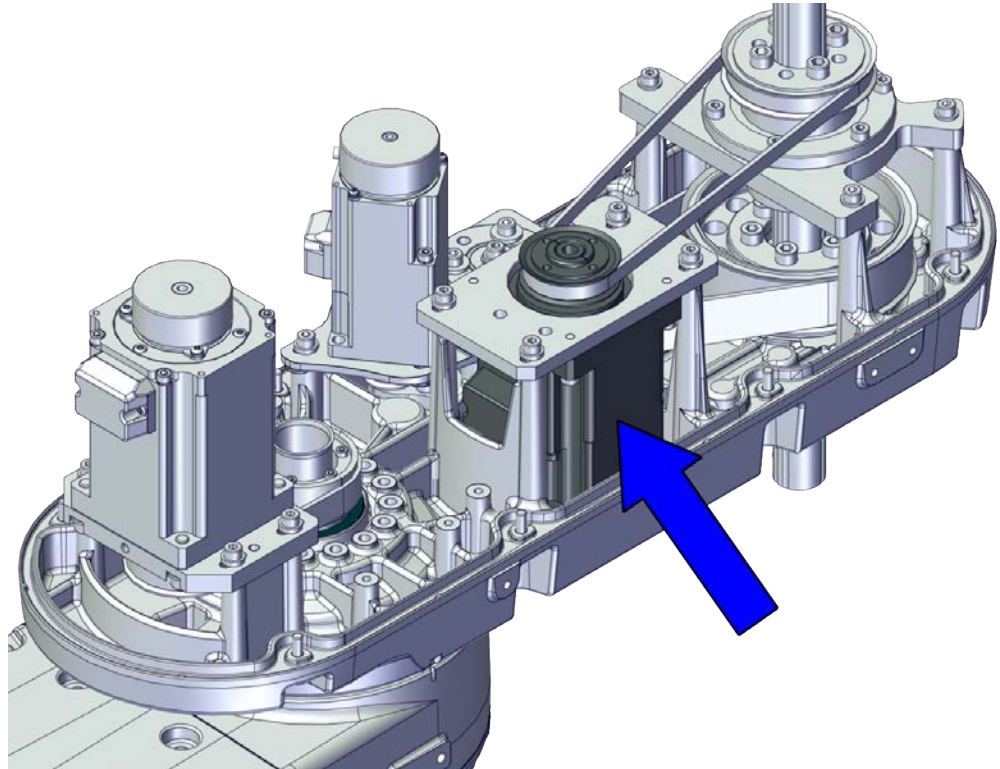

xx2100001025

Required spare parts



Note

The spare part numbers that are listed in the table can be out of date. See the latest spare parts of the IRB 920 via myABB Business Portal, www.abb.com/myABB.

Spare part	Article number	Note
Motor with pulley A3	3HAC076577-001	
Timing belt A3	3HAC070464-001	

Required tools and equipment

Equipment	Article number	Note
Standard toolkit	-	Content is defined in section Standard toolkit on page 996 .

Continues on next page

Equipment	Article number	Note
Calibration toolbox, Axis Calibration	3HAC055412-001	Delivered as a set of calibration tools. Required if Axis Calibration is the valid calibration method for the robot.
24 VDC power supply	-	Used to release the motor brakes.
Sonic tension meter	-	Used for measuring the timing belt tension.
Handheld dynamometer	-	Used for measuring the timing belt tension.

Required consumables

Consumable	Article number	Note
Cable straps	-	
Grease	3HAC029132-001	FM 222

Deciding calibration routine

Decide which calibration routine to be used, based on the information in the table. Depending on which routine is chosen, action might be required prior to beginning the repair work of the robot, see the table.

	Action	Note
1	Decide which calibration routine to use for calibrating the robot. <ul style="list-style-type: none"> Reference calibration. External cable packages (DressPack) and tools can stay fitted on the robot. Fine calibration. All external cable packages (DressPack) and tools must be removed from the robot. 	
	<p>If the robot is to be calibrated with reference calibration:</p> <p>Find previous reference values for the axis or create new reference values. These values are to be used after the repair procedure is completed, for calibration of the robot.</p> <p>If no previous reference values exist, and no new reference values can be created, then reference calibration is not possible.</p>	<p>Follow the instructions given in the reference calibration routine on the FlexPendant to create reference values.</p> <p>Creating new values requires possibility to move the robot.</p> <p>Read more about reference calibration for Axis Calibration in Reference calibration routine on page 957.</p>
	<p>If the robot is to be calibrated with fine calibration:</p> <p>Remove all external cable packages (DressPack) and tools from the robot.</p>	

Continues on next page

5 Repair



5.7.3 Replacing the axis-3 motor sub-assembly

Continued



Removing the axis-3 motor sub-assembly

Use these procedures to remove the axis-3 motor sub-assembly.

Preparations before removing the axis-3 motor sub-assembly



	Action	Note
1	Decide which calibration routine to use, and take actions accordingly prior to beginning the repair procedure.	
2	<p>If there is no enough space for the maintenance work, remove the robot from the wall and place it on the maintenance bracket.</p> <p> CAUTION</p> <p>Do not lay down the robot during the transportation, always keep it straight. If the robot lay down in any situation, the grease may come out from gearbox.</p>	
3	<p> DANGER</p> <p>Turn off all:</p> <ul style="list-style-type: none"> • electric power supply • hydraulic pressure supply • air pressure supply <p>to the robot, before entering the safeguarded space.</p>	
4	<p> CAUTION</p> <p>For robots with protection type Clean Room Always cut the paint with a knife and grind the paint edge when disassembling parts of the robot! See Cut the paint or surface on the robot before replacing parts on page 118.</p>	

Removing the process hub screws

	Action	Note
1	<p> DANGER</p> <p>Make sure that all supplies for electrical power, hydraulic pressure, and air pressure are turned off.</p>	
2	<p> CAUTION</p> <p>For robots with protection type Clean Room Always cut the paint with a knife and grind the paint edge when disassembling parts of the robot! See Cut the paint or surface on the robot before replacing parts on page 118.</p>	

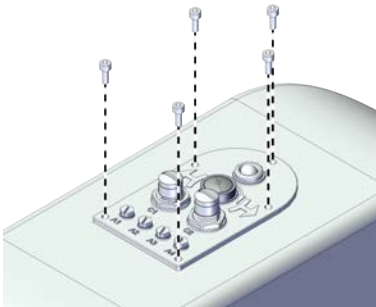
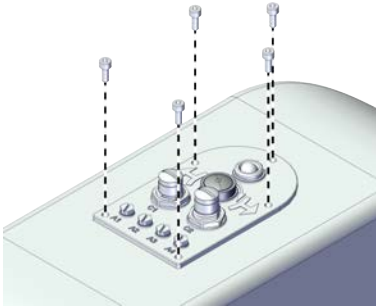

Continues on next page

5.7.3 Replacing the axis-3 motor sub-assembly
Continued

	Action	Note
3	<p>Remove the screws on the process hub.</p> <p> Note</p> <p>For robots with protection class IP54 (option 3350-540)</p> <p>For robots with protection type Clean Room (option 3351-1)</p> <p>Remove the screws on the process hub and take out the gasket.</p> <p> Tip</p> <p>Check the gasket and replace it if needed.</p>	<p>For robots with protection class IP30</p>  <p>xx2100000932</p> <p>For robots with protection class IP54 (option 3350-540)</p> <p>For robots with protection type Clean Room (option 3351-1)</p>  <p>xx2100000932</p>
4	Insert the process hub to the outer arm.	

For Clean Room/ IP54 robots

Removing the top cover and the flange with bearing



	Action	Note
1	<p> DANGER</p> <p>Make sure that all supplies for electrical power, hydraulic pressure, and air pressure are turned off.</p>	
2	<p> CAUTION</p> <p>For robots with protection type Clean Room</p> <p>Always cut the paint with a knife and grind the paint edge when disassembling parts of the robot! See Cut the paint or surface on the robot before replacing parts on page 118.</p>	

Continues on next page

5 Repair



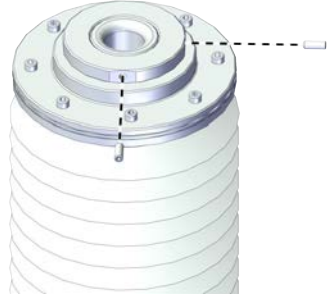

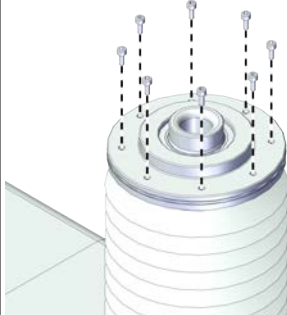
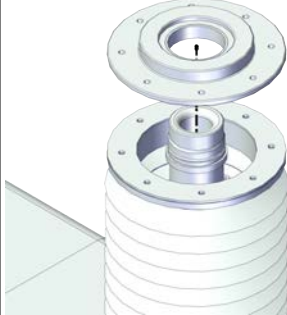
5.7.3 Replacing the axis-3 motor sub-assembly

Continued

	Action	Note
3	<p>For robots with protection class IP54 (option 3350-540) For robots with protection type Clean Room (option 3351-1) Loose the locking screws.</p>	 <p>xx2100002398</p>
4	<p>For robots with protection class IP54 (option 3350-540) For robots with protection type Clean Room (option 3351-1) Remove the top cover from the ball screw.</p>	 <p>xx2100002399</p>
5	<p>For robots with protection class IP54 (option 3350-540) For robots with protection type Clean Room (option 3351-1) Remove the screws on the flange with bearing.</p>	 <p>xx2100002401</p>
6	<p>For robots with protection class IP54 (option 3350-540) For robots with protection type Clean Room (option 3351-1) Remove the flange with bearing.</p>	 <p>xx2100002402</p>

Continues on next page

Removing the cover of the outer arm

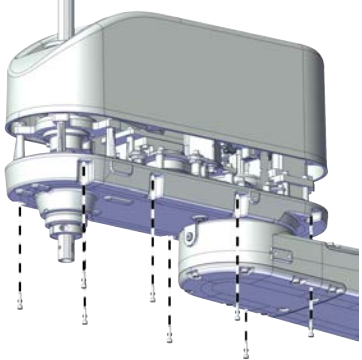
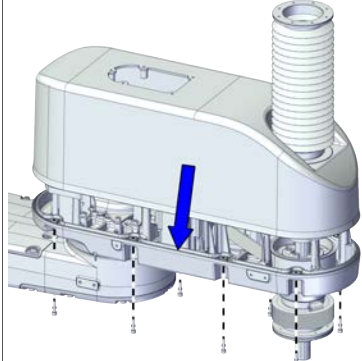
	Action	Note
1	 <p>DANGER</p> <p>Make sure that all supplies for electrical power, hydraulic pressure, and air pressure are turned off.</p>	
2	 <p>CAUTION</p> <p>For robots with protection type Clean Room Always cut the paint with a knife and grind the paint edge when disassembling parts of the robot! See Cut the paint or surface on the robot before replacing parts on page 118.</p>	
3	<p>Remove the screws on the cover of the outer arm and remove the cover.</p> <p> Note</p> <p>For robots with protection class IP54 (option 3350-540) For robots with protection type Clean Room (option 3351-1) Remove the cover with bellow and housing.</p> <p> Note</p> <p>The bellow does not need to be removed separately.</p> <p> Tip</p> <p>Check the gasket and replace it if needed.</p>	<p>For robots with protection class IP30</p>  <p>xx210000933</p> <p>For robots with protection class IP54 (option 3350-540) For robots with protection type Clean Room (option 3351-1)</p>  <p>xx2100002427</p>





Continues on next page

5 Repair

5.7.3 Replacing the axis-3 motor sub-assembly

Continued

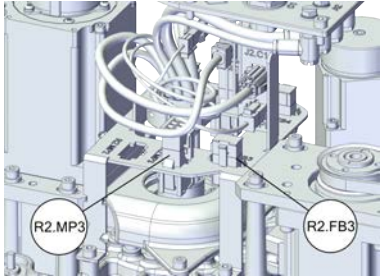
Disconnecting the connectors for axis-3 motor

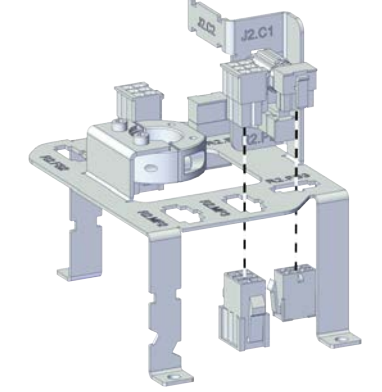

	Action	Note
1	 DANGER Make sure that all supplies for electrical power, hydraulic pressure, and air pressure are turned off.	
2	 CAUTION For robots with protection type Clean Room Always cut the paint with a knife and grind the paint edge when disassembling parts of the robot! See Cut the paint or surface on the robot before replacing parts on page 118 .	
3	Disconnect the connectors. <ul style="list-style-type: none"> • R2.MP3 • R2.FB3 	 <p>xx2100000936</p>
4	Snap loose and remove the female head of the connectors from the bracket.  Note The harness are not visible due to the cleanness requirements of the illustration. They are still existing inside the cable ferrule in the actual situation.	 <p>xx2100000937</p>

Removing the axis-3 motor sub-assembly

	Action	Note
1	 DANGER Make sure that all supplies for electrical power, hydraulic pressure, and air pressure are turned off.	

Continues on next page

5.7.3 Replacing the axis-3 motor sub-assembly
Continued

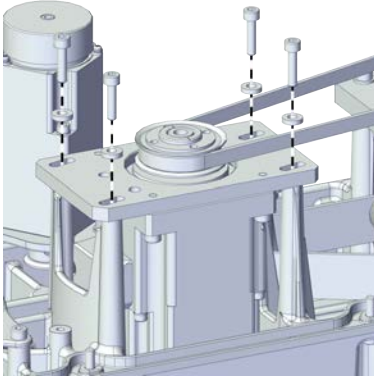
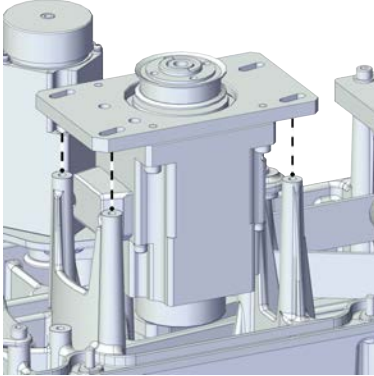
	Action	Note
2	<p> CAUTION</p> <p>For robots with protection type Clean Room Always cut the paint with a knife and grind the paint edge when disassembling parts of the robot! See <i>Cut the paint or surface on the robot before replacing parts on page 118.</i></p>	
3	<p> DANGER</p> <p>Make sure that the ball screw is supported with something. The sudden drop of the ball screw due the lost of the axis-3 motor may cause danger.</p>	
4	Remove the screws.	 <p>xx2100001178</p>
5	Remove the axis-3 motor sub-assembly and the timing belt.	 <p>xx2100001181</p>

Separating the flange from axis-3 motor sub-assembly

	Action	Note
1	<p> DANGER</p> <p>Make sure that all supplies for electrical power, hydraulic pressure, and air pressure are turned off.</p>	

Continues on next page

5 Repair

5.7.3 Replacing the axis-3 motor sub-assembly

Continued

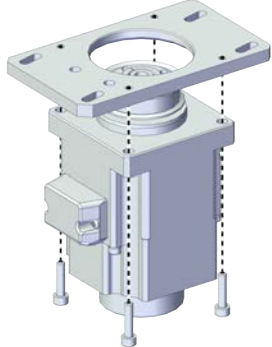
	Action	Note
2	 CAUTION For robots with protection type Clean Room Always cut the paint with a knife and grind the paint edge when disassembling parts of the robot! See Cut the paint or surface on the robot before replacing parts on page 118 .	
3	Remove the screws and washers.	 xx2100001180
4	Remove the motor.	

Refitting the axis-3 motor sub-assembly

Use these procedures to refit the axis-3 motor sub-assembly.

Refitting the flange to the axis-3 motor sub-assembly



	Action	Note
1	For robots with protection type Clean Room: Clean the joints that have been opened and wipe the parts free from particles with spirit on a lint free. See Cut the paint or surface on the robot before replacing parts on page 118  Note After all repair work, wipe the Clean Room robot free from particles with spirit on a lint free cloth.	

Continues on next page

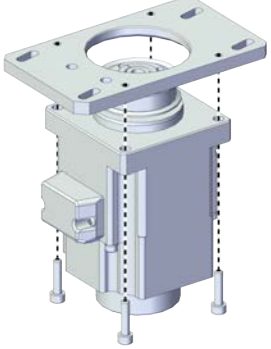
5.7.3 Replacing the axis-3 motor sub-assembly
Continued

	Action	Note
2	Install the flange to the motor and secure with screws.	<p>Screws: Hex socket head cap screw M5x16 12.9 Lafre 2C2B/FC6.9 (4 pcs) Washers: Plain washer 11x5.3x1.2 Steel (4 pcs) Tightening torque: 2.3 Nm ±10% 3HAB3409-212</p>  <p>xx2100001180</p>

Refitting the axis-3 motor sub-assembly

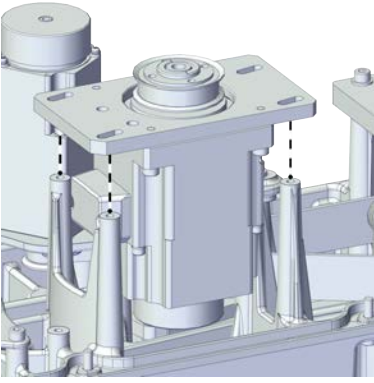

	Action	Note
1	<p>For robots with protection type Clean Room: Clean the joints that have been opened and wipe the parts free from particles with spirit on a lint free. See Cut the paint or surface on the robot before replacing parts on page 118</p> <p> Note After all repair work, wipe the Clean Room robot free from particles with spirit on a lint free cloth.</p>	
2	<p>Refit the motor to the outer arm.</p> <p> Tip Move the internal harness out of the way.</p>	 <p>xx2100001181</p>
3	Refit the timing belt to the pulley on the ball screw and the motor. Ensure that the belt runs correctly in the grooves.	Timing belt A3: 3HAC070464-001

Continues on next page

5 Repair

5.7.3 Replacing the axis-3 motor sub-assembly

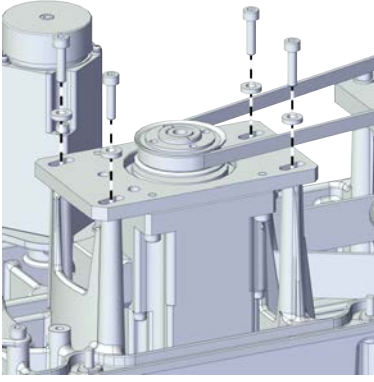
Continued

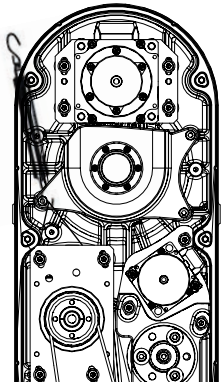
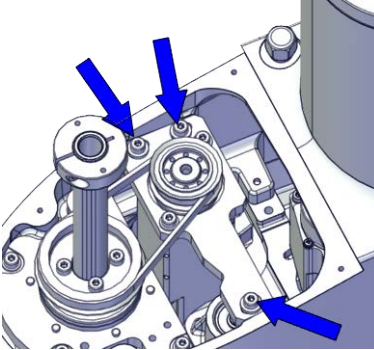





	Action	Note
4	Refit the screws and washers without fully tightened.	<p>Screws: Hex socket head cap screw M4x20 12.9 Lafre 2C2B/FC6.9 (4 pcs) Washers: Washer 4.3x10x2 steel (4 pcs) Tightening torque: 2.6 Nm \pm10%</p>  <p>xx2100001178</p>
5	Hang a strap to the motor.	
6	<p>Use a handheld dynamometer hooking to the strap and pull the dynamometer to make the tension falling in the allowed force range.</p> <p> Note</p> <p>During the measurement, make sure that all interferences that may affect the force are removed. Pay attention to the force application direction.</p>	 <p>xx2100001126</p>
7	Fasten the screws to the recommended tightening torque.	
8	Use a sonic tension meter to measure the timing belt tension.	<p>Used belt: 139 New belt:110</p>
9	If the timing belt tension does not meet the requirement, loosen the motor screws and readjust.	 <p>xx1800002887</p>

Continues on next page

5.7.3 Replacing the axis-3 motor sub-assembly
Continued

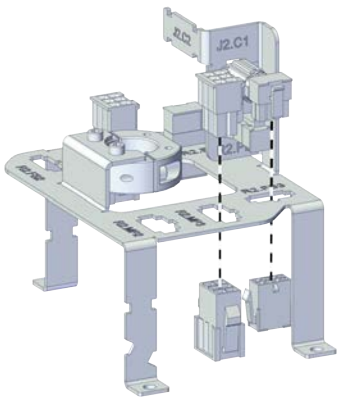
	Action	Note
10	Remove the axis-3 belt tension adjustment tool.	

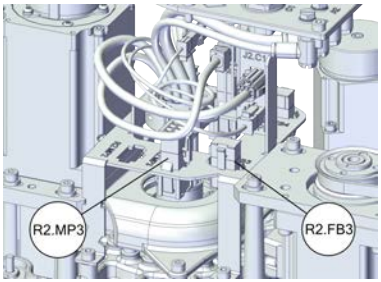
Reconnecting the connectors for axis-3 motor

	Action	Note
1	<p>For robots with protection type Clean Room: Clean the joints that have been opened and wipe the parts free from particles with spirit on a lint free. See Cut the paint or surface on the robot before replacing parts on page 118</p> <p> Note</p> <p>After all repair work, wipe the Clean Room robot free from particles with spirit on a lint free cloth.</p>	
2	<p>Insert the female head of the connectors to the bracket accordingly.</p> <p> Tip</p> <p>The mistake proofing measure has been applied to the connectors, the connectors may be damaged if excessive force is used.</p> <p> Note</p> <p>The harness are not visible due to the cleanness requirements of the illustration. They are still existing inside the cable ferrule in the actual situation.</p>	 <p>xx2100000937</p>
3	<p>Reconnect the connectors.</p> <ul style="list-style-type: none"> • R2.MP3 • R2.FB3 <p> Tip</p> <p>See the number markings on the connectors for help to find the corresponding connector.</p>	 <p>xx2100000936</p>
4	<p>Route the cabling on the axis-3 motor.</p> <p> CAUTION</p> <p>Correct cable routing is highly important. If the cables are routed and secured incorrectly the cables can be damaged.</p>	





Continues on next page

5 Repair

5.7.3 Replacing the axis-3 motor sub-assembly

Continued

Refitting the cover of the outer arm

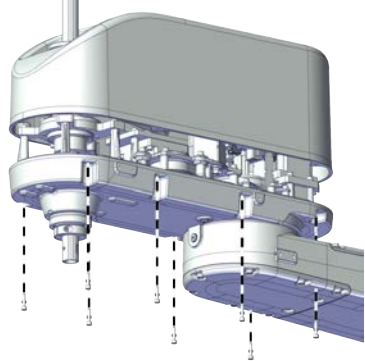
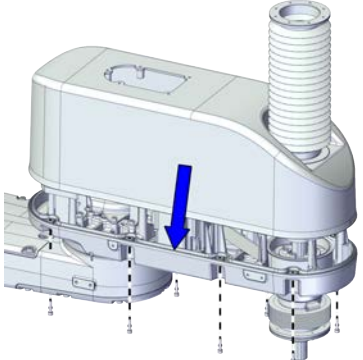
	Action	Note
1	<p>For robots with protection type Clean Room: Clean the joints that have been opened and wipe the parts free from particles with spirit on a lint free. See Cut the paint or surface on the robot before replacing parts on page 118</p> <p> Note</p> <p>After all repair work, wipe the Clean Room robot free from particles with spirit on a lint free cloth.</p>	
2	<p>Refit the cover.</p> <p> Note</p> <p>For robots with protection class IP54 (option 3350-540) For robots with protection type Clean Room (option 3351-1)</p> <p>Refit the cover with bellow. Check the gasket for the outer arm cover.</p> <p> Tip</p> <p>Replace the gasket if needed.</p> <p> CAUTION</p> <p>The gasket is in the outer arm.</p>	<p>Screw: Hex socket head cap screw M4x16 12.9 Lafre 2C2B/FC6.9 (8 pcs) Tightening torque: 2 Nm ±10%</p> <p>For robots with protection class IP30 (option 3350-300)</p>  <p>xx210000933</p>
3	<p>Refit the screws.</p>	<p>For robots with protection class IP54 (option 3350-540) For robots with protection type Clean Room (option 3351-1)</p>  <p>xx2100002427</p>

Continues on next page

For Clean Room/ IP54 robots

Refitting the top cover and the flange with bearing

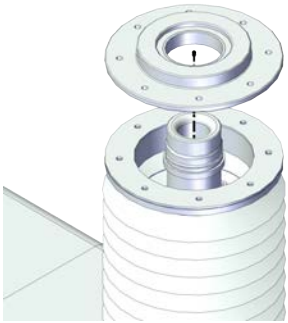
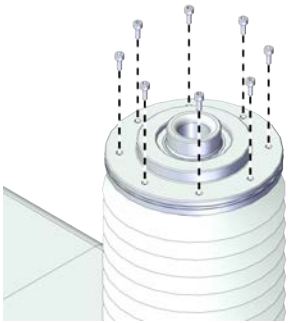

	Action	Note
1	<p>For robots with protection type Clean Room: Clean the joints that have been opened and wipe the parts free from particles with spirit on a lint free. See Cut the paint or surface on the robot before replacing parts on page 118</p> <p> Note</p> <p>After all repair work, wipe the Clean Room robot free from particles with spirit on a lint free cloth.</p>	
2	<p>For robots with protection class IP54 (option 3350-540) For robots with protection type Clean Room (option 3351-1) Install the flange with bearing to the extension shaft.</p>	 <p>xx2100002402</p>
3	<p>For robots with protection class IP54 (option 3350-540) For robots with protection type Clean Room (option 3351-1) Refit the screws to the flange with bearing.</p>	<p>Screws: Hex socket head cap screw M2.5x6 12.9 Lafre 2C2B/FC6.9 (8 pcs) Tightening torque: 0.8 Nm ±10%</p>  <p>xx2100002401</p>

Continues on next page

5 Repair

5.7.3 Replacing the axis-3 motor sub-assembly

Continued

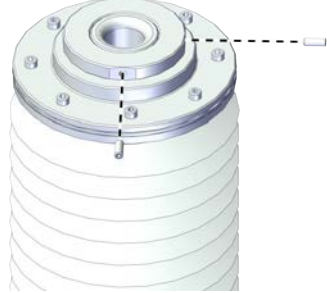

	Action	Note
4	<p>For robots with protection class IP54 (option 3350-540) For robots with protection type Clean Room (option 3351-1) Refit the top cover to the ball screw.</p> <p> Tip</p> <p>The top surface of the cover should be flush with the top end of the ball screw.</p>	 <p>xx2100002399</p>
5	<p>For robots with protection class IP54 (option 3350-540) For robots with protection type Clean Room (option 3351-1) Refit the locking screws.</p>	<p>Screws: Hexagon socket set screws with flat point, ISO 4026 stainless steel M3x8 (2 pcs) Tightening torque: 0.4 Nm \pm10%</p>  <p>xx2100002398</p>

Securing the process hub to outer arm cover

	Action	Note
1	<p>For robots with protection type Clean Room: Clean the joints that have been opened and wipe the parts free from particles with spirit on a lint free. See Cut the paint or surface on the robot before replacing parts on page 118</p> <p> Note</p> <p>After all repair work, wipe the Clean Room robot free from particles with spirit on a lint free cloth.</p>	
2	Insert the process hub from the outer arm cover.	

Continues on next page

5.7.3 Replacing the axis-3 motor sub-assembly
Continued

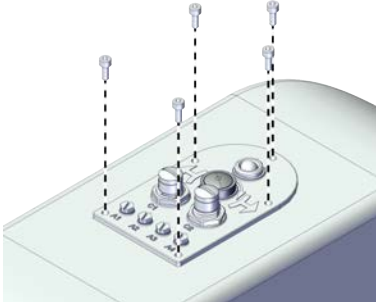
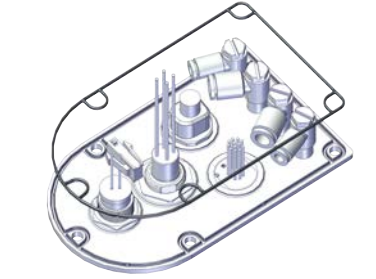
	Action	Note
3	<p>Secure the process hub to the outer arm cover with the screws.</p> <p> Note</p> <p>For robots with protection class IP54 (option 3350-540)</p> <p>For robots with protection type Clean Room (option 3351-1)</p> <p>Check the gasket for the process hub.</p> <p> Tip</p> <p>Replace the gasket if needed.</p> <p> CAUTION</p> <p>Be aware of the cabling that is attached to the cover! The cover can not be removed completely until the connectors are disconnected, as shown in following steps.</p>	<p>Screws: Hex socket head cap screw M4x10 12.9 Lafre 2C2B/FC6.9 (5 pcs)</p> <p>Tightening torque: 2.6 Nm±10%</p> <p>For robots with protection class IP30 (option 3350-300)</p>  <p>xx2100000932</p> <p>For robots with protection class IP54 (option 3350-540)</p> <p>For robots with protection type Clean Room (option 3351-1)</p>  <p>xx2100002438</p>

Concluding procedure

	Action	Note
1	<p>For robots with protection type Clean Room: Seal and paint the joints that have been opened. See Cut the paint or surface on the robot before replacing parts on page 118</p> <p> Note</p> <p>After all repair work, wipe the Clean Room robot free from particles with spirit on a lint free cloth.</p>	
2	Recalibrate the robot.	Calibration is detailed in section Calibration on page 945 .

Continues on next page

5 Repair

5.7.3 Replacing the axis-3 motor sub-assembly

Continued

	Action	Note
3	 DANGER Make sure all safety requirements are met when performing the first test run.	

5.7.4 Replacing the axis-4 motor sub-assembly

Location of the axis-4 motor sub-assembly

The axis-4 motor sub-assembly is located as shown in the figure.

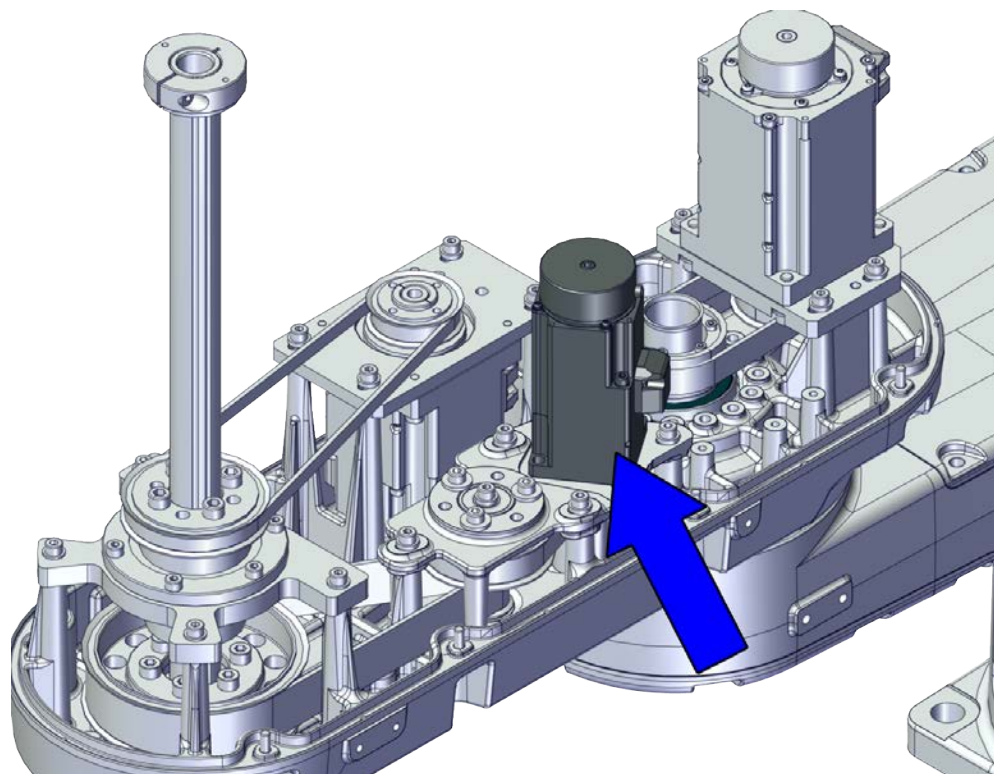

xx2100001026

Required spare parts



Note

The spare part numbers that are listed in the table can be out of date. See the latest spare parts of the IRB 920 via myABB Business Portal, www.abb.com/myABB.

Spare part	Article number	Note
Motor with pulley A4	3HAC076578-001	
Timing belt, A4-1	3HAC070470-001	
Timing belt, A4-2	3HAC070471-001	
Transmission module	3HAC076579-001	

Required tools and equipment

Equipment	Article number	Note
Standard toolkit	-	Content is defined in section Standard toolkit on page 996 .

Continues on next page

5 Repair

5.7.4 Replacing the axis-4 motor sub-assembly

Continued

Equipment	Article number	Note
Calibration toolbox, Axis Calibration	3HAC055412-001	Delivered as a set of calibration tools. Required if Axis Calibration is the valid calibration method for the robot.
24 VDC power supply	-	Used to release the motor brakes.
Sonic tension meter	-	Used for measuring the timing belt tension.
Handheld dynamometer	-	Used for measuring the timing belt tension.

Required consumables

Consumable	Article number	Note
Cable straps	-	
Grease	3HAC029132-001	FM 222

Deciding calibration routine

Decide which calibration routine to be used, based on the information in the table. Depending on which routine is chosen, action might be required prior to beginning the repair work of the robot, see the table.



	Action	Note
1	<p>Decide which calibration routine to use for calibrating the robot.</p> <ul style="list-style-type: none"> Reference calibration. External cable packages (DressPack) and tools can stay fitted on the robot. Fine calibration. All external cable packages (DressPack) and tools must be removed from the robot. 	
	<p>If the robot is to be calibrated with reference calibration:</p> <p>Find previous reference values for the axis or create new reference values. These values are to be used after the repair procedure is completed, for calibration of the robot.</p> <p>If no previous reference values exist, and no new reference values can be created, then reference calibration is not possible.</p>	<p>Follow the instructions given in the reference calibration routine on the FlexPendant to create reference values.</p> <p>Creating new values requires possibility to move the robot.</p> <p>Read more about reference calibration for Axis Calibration in Reference calibration routine on page 957.</p>
	<p>If the robot is to be calibrated with fine calibration:</p> <p>Remove all external cable packages (DressPack) and tools from the robot.</p>	

Continues on next page

Removing the axis-4 motor sub-assembly

Use these procedures to remove the axis-4 motor sub-assembly.

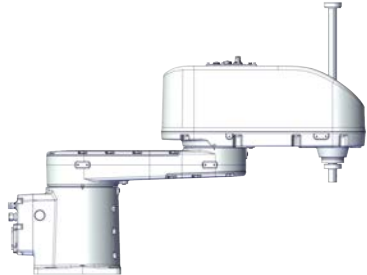
Preparations before removing the axis-4 motor sub-assembly

	Action	Note
1	Decide which calibration routine to use, and take actions accordingly prior to beginning the repair procedure.	
2	<p>If there is no enough space for the maintenance work, remove the robot from the wall and place it on the maintenance bracket.</p> <p> CAUTION</p> <p>Do not lay down the robot during the transportation, always keep it straight. If the robot lay down in any situation, the grease may come out from gearbox.</p>	
3	Jog all axes to zero position.	 <p>xx2100000930</p>
4	<p> DANGER</p> <p>Turn off all:</p> <ul style="list-style-type: none"> • electric power supply • hydraulic pressure supply • air pressure supply <p>to the robot, before entering the safeguarded space.</p>	
5	<p> CAUTION</p> <p>For robots with protection type Clean Room Always cut the paint with a knife and grind the paint edge when disassembling parts of the robot! See <i>Cut the paint or surface on the robot before replacing parts on page 118.</i></p>	





Continues on next page

5 Repair

5.7.4 Replacing the axis-4 motor sub-assembly

Continued



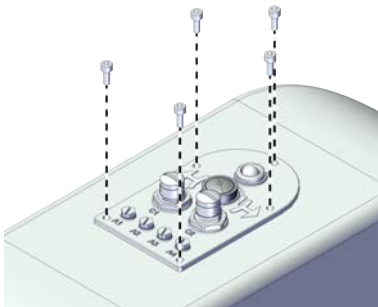
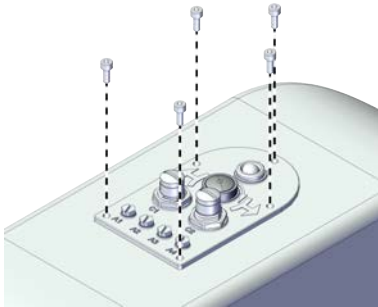

Removing the process hub screws

	Action	Note
1	 DANGER Make sure that all supplies for electrical power, hydraulic pressure, and air pressure are turned off.	
2	 CAUTION For robots with protection type Clean Room Always cut the paint with a knife and grind the paint edge when disassembling parts of the robot! See Cut the paint or surface on the robot before replacing parts on page 118 .	
3	Remove the screws on the process hub.  Note For robots with protection class IP54 (option 3350-540) For robots with protection type Clean Room (option 3351-1) Remove the screws on the process hub and take out the gasket.  Tip Check the gasket and replace it if needed.	For robots with protection class IP30  <small>xx2100000932</small> For robots with protection class IP54 (option 3350-540) For robots with protection type Clean Room (option 3351-1)  <small>xx2100000932</small>
4	Insert the process hub to the outer arm.	

Continues on next page

For Clean Room/ IP54 robots

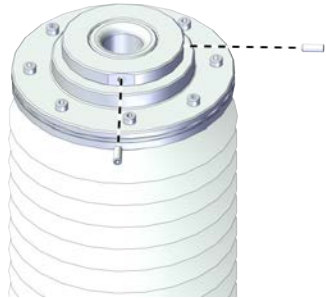
Removing the top cover and the flange with bearing

	Action	Note
1	 DANGER Make sure that all supplies for electrical power, hydraulic pressure, and air pressure are turned off.	
2	 CAUTION For robots with protection type Clean Room Always cut the paint with a knife and grind the paint edge when disassembling parts of the robot! See Cut the paint or surface on the robot before replacing parts on page 118 .	
3	For robots with protection class IP54 (option 3350-540) For robots with protection type Clean Room (option 3351-1) Loose the locking screws.	 <p>xx2100002398</p>
4	For robots with protection class IP54 (option 3350-540) For robots with protection type Clean Room (option 3351-1) Remove the top cover from the ball screw.	 <p>xx2100002399</p>

Continues on next page



5 Repair

5.7.4 Replacing the axis-4 motor sub-assembly

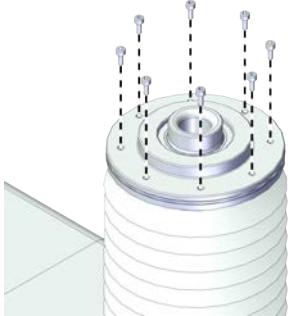
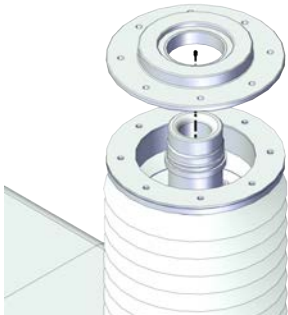
Continued



	Action	Note
5	<p>For robots with protection class IP54 (option 3350-540)</p> <p>For robots with protection type Clean Room (option 3351-1)</p> <p>Remove the screws on the flange with bearing.</p>	 <p>xx2100002401</p>
6	<p>For robots with protection class IP54 (option 3350-540)</p> <p>For robots with protection type Clean Room (option 3351-1)</p> <p>Remove the flange with bearing.</p>	 <p>xx2100002402</p>

Removing the cover of the outer arm

	Action	Note
1	 <p>DANGER</p> <p>Make sure that all supplies for electrical power, hydraulic pressure, and air pressure are turned off.</p>	
2	 <p>CAUTION</p> <p>For robots with protection type Clean Room</p> <p>Always cut the paint with a knife and grind the paint edge when disassembling parts of the robot! See Cut the paint or surface on the robot before replacing parts on page 118.</p>	

Continues on next page

5.7.4 Replacing the axis-4 motor sub-assembly
Continued

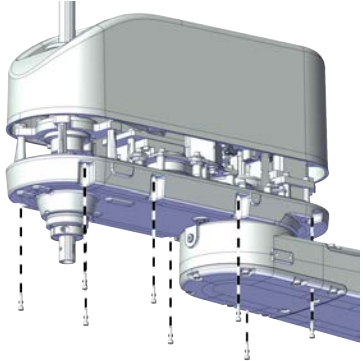
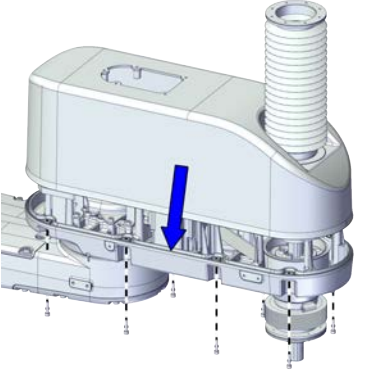
	Action	Note
3	<p>Remove the screws on the cover of the outer arm and remove the cover.</p> <p> Note</p> <p>For robots with protection class IP54 (option 3350-540) For robots with protection type Clean Room (option 3351-1) Remove the cover with bellow and housing.</p> <p> Note</p> <p>The bellow does not need to be removed separately.</p> <p> Tip</p> <p>Check the gasket and replace it if needed.</p>	<p>For robots with protection class IP30</p>  <p>xx2100000933</p> <p>For robots with protection class IP54 (option 3350-540) For robots with protection type Clean Room (option 3351-1)</p>  <p>xx2100002427</p>

Disconnecting the connectors for axis-4 motor



	Action	Note
1	<p>For robots with protection type Clean Room: Clean the joints that have been opened and wipe the parts free from particles with spirit on a lint free. See Cut the paint or surface on the robot before replacing parts on page 118</p> <p> Note</p> <p>After all repair work, wipe the Clean Room robot free from particles with spirit on a lint free cloth.</p>	

Continues on next page

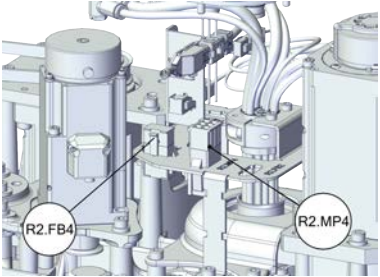

5 Repair

5.7.4 Replacing the axis-4 motor sub-assembly

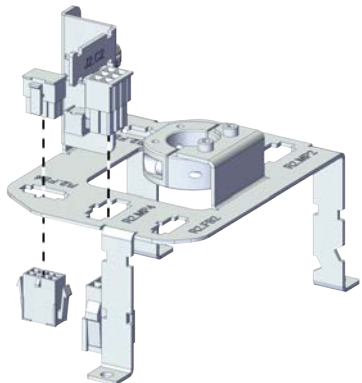
Continued

	Action	Note
2	Disconnect the axis-4 motor connectors. <ul style="list-style-type: none"> • R2.MP4 • R2.FB4 	 <p>xx2100000938</p>
3	Snap loose and remove the female head of the connectors from the bracket.  Note The harness are not visible due to the cleanness requirements of the illustration. They are still existing inside the cable ferrule in the actual situation.	 <p>xx2100000939</p>

Removing the axis-3 timing belt



	Action	Note
1	 DANGER Make sure that all supplies for electrical power, hydraulic pressure, and air pressure are turned off.	
2	 CAUTION For robots with protection type Clean Room Always cut the paint with a knife and grind the paint edge when disassembling parts of the robot! See Cut the paint or surface on the robot before replacing parts on page 118 .	
3	 DANGER Make sure that the ball screw is supported with something. The sudden drop of the ball screw due the lost of the axis-3 motor may cause danger.	

Continues on next page

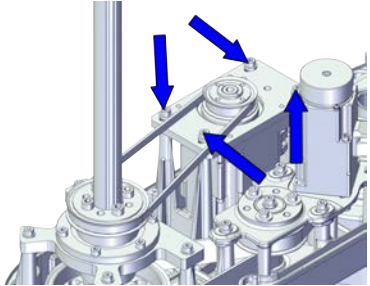
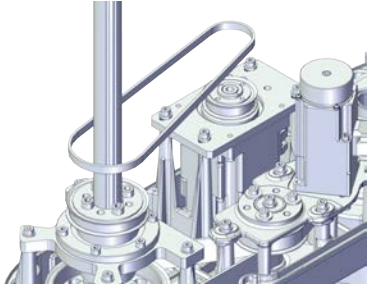
5.7.4 Replacing the axis-4 motor sub-assembly
Continued

	Action	Note
4	Loosen the screws of the axis-3 motor sub-assembly to let the axis-3 timing belt free.	 <p>xx2100001078</p>
5	Remove the timing belt.	 <p>xx2100001079</p>

Releasing the ball screw flange

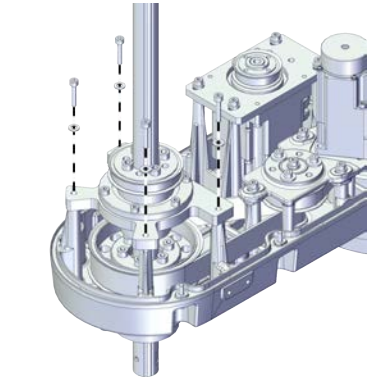
	Action	Note
1	 DANGER Make sure that all supplies for electrical power, hydraulic pressure, and air pressure are turned off.	
2	 CAUTION For robots with protection type Clean Room Always cut the paint with a knife and grind the paint edge when disassembling parts of the robot! See Cut the paint or surface on the robot before replacing parts on page 118 .	
3	Removing the screws of the ball screw flange to make enough space for removing the axis-4 second timing belt.	 <p>xx2100001082</p>



Continues on next page

5 Repair



5.7.4 Replacing the axis-4 motor sub-assembly

Continued

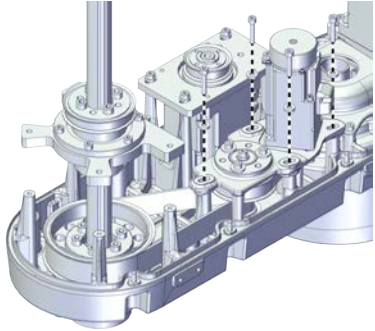
Removing the transmission module assembly



	Action	Note
1	 DANGER Make sure that all supplies for electrical power, hydraulic pressure, and air pressure are turned off.	
2	 CAUTION For robots with protection type Clean Room Always cut the paint with a knife and grind the paint edge when disassembling parts of the robot! See Cut the paint or surface on the robot before replacing parts on page 118 .	
3	Removing the screws of the transmission module assembly.	 xx2100001091
4	Take out the transmission module assembly with the axis-4-2 timing belt.	

Removing the axis-4 motor sub-assembly

	Action	Note
1	 DANGER Make sure that all supplies for electrical power, hydraulic pressure, and air pressure are turned off.	
2	 CAUTION For robots with protection type Clean Room Always cut the paint with a knife and grind the paint edge when disassembling parts of the robot! See Cut the paint or surface on the robot before replacing parts on page 118 .	

Continues on next page

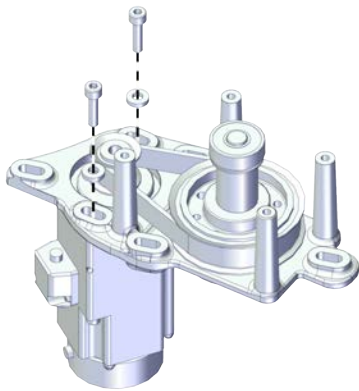

5.7.4 Replacing the axis-4 motor sub-assembly
Continued

	Action	Note
3	Remove the screws and washers.	 <p>xx2100001094</p>
4	Remove the motor from the transmission module.  Tip Move the internal harness out of the way.	
5	Remove the timing belt from the transmission module.	

Refitting the axis-4 motor sub-assembly

Use these procedures to refit the axis-4 motor sub-assembly.

Refitting the axis-4 motor sub-assembly to the transmission module

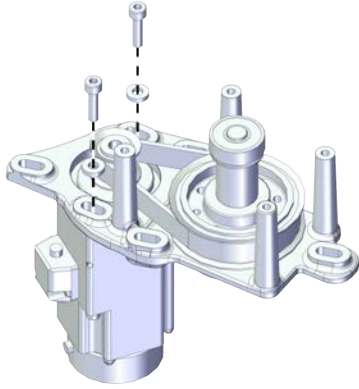
	Action	Note
1	For robots with protection type Clean Room: Clean the joints that have been opened and wipe the parts free from particles with spirit on a lint free. See Cut the paint or surface on the robot before replacing parts on page 118  Note After all repair work, wipe the Clean Room robot free from particles with spirit on a lint free cloth.	
2	Refit the motor to the transmission module.  Tip Move the internal harness out of the way.	Screws: Hex socket head cap screw M4x16 12.9 Lafre 2C2B/FC6.9 (2 pcs) Washers: Washer 4.3x10x2 steel (2 pcs) Tightening torque: 2.6 Nm ±10%
3	Refit the screws and washers.	 <p>xx2100001094</p>



Continues on next page

5 Repair

5.7.4 Replacing the axis-4 motor sub-assembly

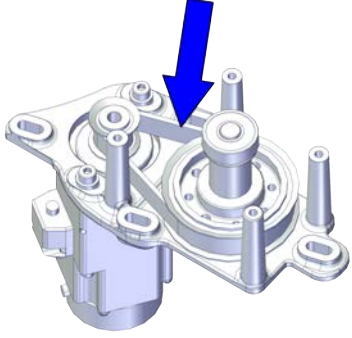
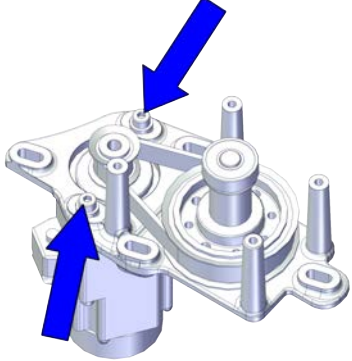

Continued

Refitting the axis-4 timing belt

	Action	Note
1	<p>For robots with protection type Clean Room: Clean the joints that have been opened and wipe the parts free from particles with spirit on a lint free. See Cut the paint or surface on the robot before replacing parts on page 118</p> <p> Note</p> <p>After all repair work, wipe the Clean Room robot free from particles with spirit on a lint free cloth.</p>	
2	Refit the timing belt to the pulley.	<p>Timing belt, A4-1: 3HAC070470-001</p>  <p>xx2100001097</p>
3	Refit the timing belt to the motor. Ensure that the belt runs correctly in the grooves.	
4	Refit the screws and washers without fully tightened.	<p>Screws: Hex socket head cap screw M4x16 12.9 Lafre 2C2B/FC6.9 (2 pcs) Washers: Plain washer machining 4.2x9x2 steel (2 pcs) Tightening torque: 2.6 Nm \pm10%</p>  <p>xx2100001095</p>
5	<p>Hang a strap to the motor and hold the transmission module.</p> <p> Note</p> <p>Just tighten the tool.</p>	

Continues on next page

5.7.4 Replacing the axis-4 motor sub-assembly
Continued

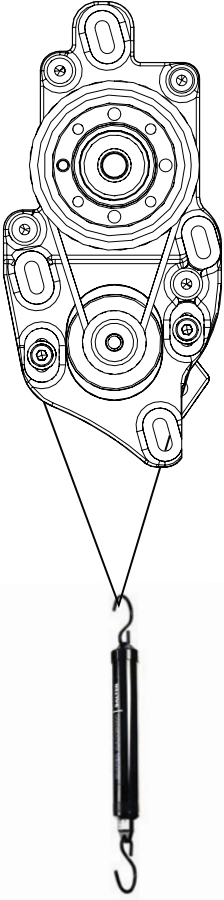
	Action	Note
6	<p>Use a handheld dynamometer hooking to the strap and pull the dynamometer to make the tension falling in the allowed force range.</p> <p> Note</p> <p>During the measurement, make sure that all interferences that may affect the force are removed. Pay attention to the force application direction.</p> <p> Tip</p> <p>If the ball screw will interfere with the handheld dynamometer, adjust the ball screw manually.</p>	 <p>xx2100001128</p>
7	Fasten the screws to the recommended tightening torque.	
8	Use a sonic tension meter to measure the timing belt tension.	Used belt: 312 New belt:245
9	If the timing belt tension does not meet the requirement, loosen the motor screws and readjust.	
10	Remove the axis-4 belt tension adjustment tool.	

Refitting the transmission module assembly to the outer arm

	Action	Note
1	<p>For robots with protection type Clean Room: Clean the joints that have been opened and wipe the parts free from particles with spirit on a lint free. See Cut the paint or surface on the robot before replacing parts on page 118</p> <p> Note</p> <p>After all repair work, wipe the Clean Room robot free from particles with spirit on a lint free cloth.</p>	

Continues on next page

5 Repair

5.7.4 Replacing the axis-4 motor sub-assembly

Continued

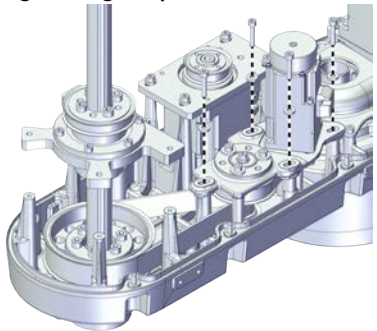

	Action	Note
2	<p>Refit the transmission module assembly to the outer arm.</p> <p> Tip</p> <p>Place the axis-4 second timing belt through the ball screw flange.</p>	<p>Screws: Hex socket head cap screw M4x20 12.9 Lafre 2C2B/FC6.9 (4 pcs)</p> <p>Washers: Plain washer machining 4.2x9x2 steel (4 pcs)</p> <p>Tightening torque: 2.6 Nm \pm10%</p>  <p>xx2100001091</p>
3	Secure with the screws without fully tightened.	

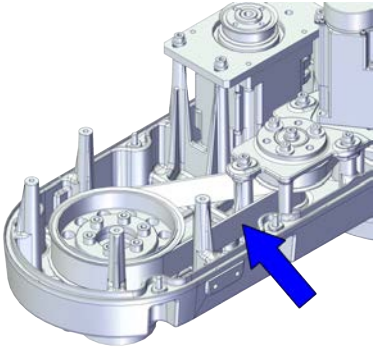
Refitting the axis-4 second timing belt to the pulley

	Action	Note
1	<p>For robots with protection type Clean Room: Clean the joints that have been opened and wipe the parts free from particles with spirit on a lint free. See Cut the paint or surface on the robot before replacing parts on page 118</p> <p> Note</p> <p>After all repair work, wipe the Clean Room robot free from particles with spirit on a lint free cloth.</p>	
2	<p>Refit the belt to the pulley. Ensure that the belt runs correctly in the grooves.</p>	<p>Timing belt, A4-2: 3HAC070471-001</p>  <p>xx2100001086</p>

Continues on next page

Fastening the ball screw flange

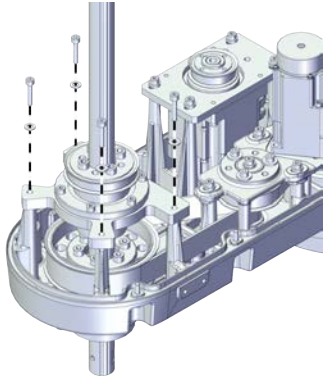
	Action	Note
1	 DANGER Make sure that all supplies for electrical power, hydraulic pressure, and air pressure are turned off.	
2	 CAUTION For robots with protection type Clean Room Always cut the paint with a knife and grind the paint edge when disassembling parts of the robot! See Cut the paint or surface on the robot before replacing parts on page 118 .	
3	 DANGER Make sure that the ball screw is supported with something. The sudden drop of the ball screw due the lost of the axis-3 motor may cause danger.	
4	Tighten the screws of the ball screw flange.	 xx2100001082

Adjusting the axis-4 second timing belt tension



	Action	Note
1	 DANGER Make sure that all supplies for electrical power, hydraulic pressure, and air pressure are turned off.	

Continues on next page

5 Repair





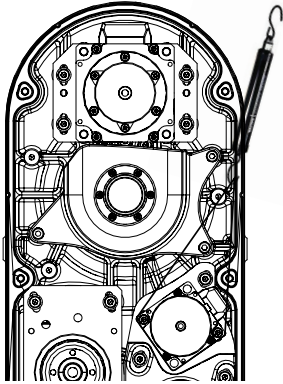
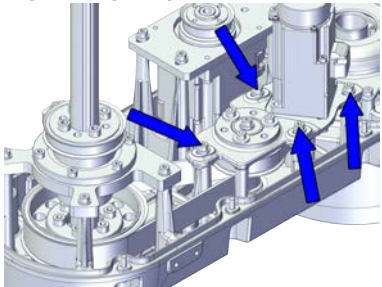

5.7.4 Replacing the axis-4 motor sub-assembly

Continued

	Action	Note
2	 CAUTION For robots with protection type Clean Room Always cut the paint with a knife and grind the paint edge when disassembling parts of the robot! See Cut the paint or surface on the robot before replacing parts on page 118 .	
3	 DANGER Make sure that the ball screw is supported with something. The sudden drop of the ball screw due the lost of the axis-3 motor may cause danger.	
4	Hang a strong strap to the motor.	
5	Use a handheld dynamometer hooking to the strap and pull the dynamometer to make the tension falling in the allowed force range.  Note During the measurement, make sure that all interferences that may affect the force are removed. Pay attention to the force application direction.	Used belt: 100 New belt:240  xx2100001127
6	Fasten the screws on the transmission module to the recommended tightening torque.	Tightening torque: 2.6 Nm \pm 10%  xx2100001087
7	Use a sonic tension meter to measure the timing belt tension.	Used belt: 202 New belt:180
8	If the timing belt tension does not meet the requirement, loosen the motor screws and readjust.	

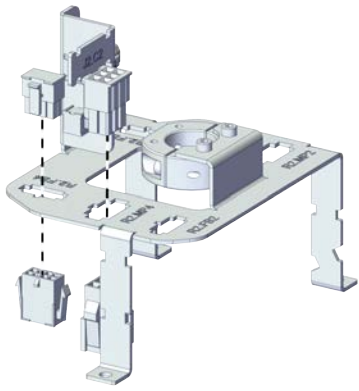
Continues on next page

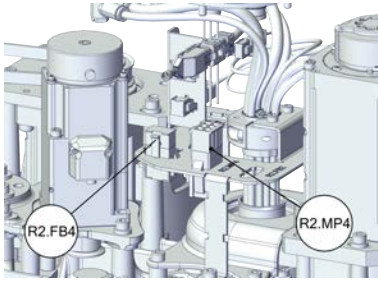
Reconnecting the connectors for axis-4 motor

	Action	Note
1	<p>For robots with protection type Clean Room: Clean the joints that have been opened and wipe the parts free from particles with spirit on a lint free. See Cut the paint or surface on the robot before replacing parts on page 118</p> <p> Note</p> <p>After all repair work, wipe the Clean Room robot free from particles with spirit on a lint free cloth.</p>	
	<p>Insert the female head of the connectors to the bracket accordingly.</p> <p> Tip</p> <p>The mistake proofing measure has been applied to the connectors, the connectors may be damaged if excessive force is used.</p> <p> Note</p> <p>The harness are not visible due to the cleanness requirements of the illustration. They are still existing inside the cable ferrule in the actual situation.</p>	 <p>xx210000939</p>
2	<p>Reconnect the connectors.</p> <ul style="list-style-type: none"> • R2.MP4 • R2.FB4 <p> Tip</p> <p>See the number markings on the connectors for help to find the corresponding connector.</p>	 <p>xx210000938</p>
3	<p>Route the cabling on the axis-4 motor.</p> <p> CAUTION</p> <p>Correct cable routing is highly important. If the cables are routed and secured incorrectly the cables can be damaged.</p>	

Continues on next page

5 Repair

5.7.4 Replacing the axis-4 motor sub-assembly

Continued

Refitting the axis-3 timing belt

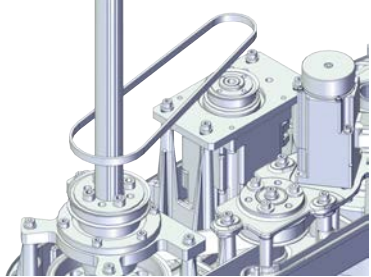
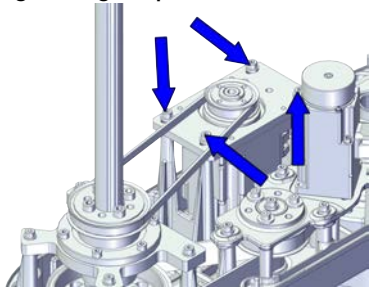
	Action	Note
1	<p>For robots with protection type Clean Room: Clean the joints that have been opened and wipe the parts free from particles with spirit on a lint free. See Cut the paint or surface on the robot before replacing parts on page 118</p> <p> Note</p> <p>After all repair work, wipe the Clean Room robot free from particles with spirit on a lint free cloth.</p>	
2	<p>Refit the timing belt to the pulley on the ball screw and the motor. Ensure that the belt runs correctly in the grooves.</p>	<p>Timing belt A3: 3HAC070464-001</p>  <p>xx2100001079</p>
3	<p>Secure the screws and washers without fully tightened.</p>	<p>Screws: Hex socket head cap screw M4x16 12.9 Lafre 2C2B/FC6.9 (4 pcs) Washers: Plain washer machining 4.2x9x2 steel (4 pcs) Tightening torque: 2.6 Nm ±10%</p>  <p>xx2100001078</p>
4	<p>Hang a strap to the hook on the motor.</p>	

Continues on next page

5.7.4 Replacing the axis-4 motor sub-assembly

Continued

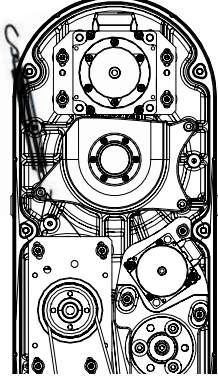
	Action	Note
5	<p>Use a handheld dynamometer hooking to the strap and pull the dynamometer to make the tension falling in the allowed force range.</p> <p> Note</p> <p>During the measurement, make sure that all interferences that may affect the force are removed. Pay attention to the force application direction.</p>	<p>Used belt: 36.6 New belt:40</p>  <p>xx2100001126</p>
6	<p>Use a sonic tension meter to measure the timing belt tension.</p>	<p>Used belt: 139 New belt:110</p>
7	<p>If the timing belt tension does not meet the requirement, loosen the motor screws and readjust.</p>	

Refitting the cover of the outer arm



	Action	Note
1	<p>For robots with protection type Clean Room: Clean the joints that have been opened and wipe the parts free from particles with spirit on a lint free. See Cut the paint or surface on the robot before replacing parts on page 118</p> <p> Note</p> <p>After all repair work, wipe the Clean Room robot free from particles with spirit on a lint free cloth.</p>	

Continues on next page

5 Repair

5.7.4 Replacing the axis-4 motor sub-assembly

Continued

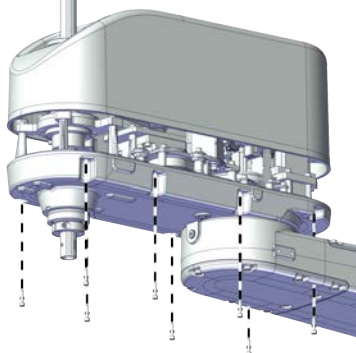
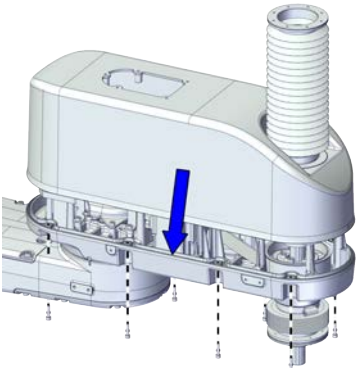
	Action	Note
2	<p>Refit the cover.</p> <p> Note</p> <p>For robots with protection class IP54 (option 3350-540)</p> <p>For robots with protection type Clean Room (option 3351-1)</p> <p>Refit the cover with bellow.</p> <p>Check the gasket for the outer arm cover.</p> <p> Tip</p> <p>Replace the gasket if needed.</p> <p> CAUTION</p> <p>The gasket is in the outer arm.</p>	<p>Screw: Hex socket head cap screw M4x16 12.9 Lafre 2C2B/FC6.9 (8 pcs)</p> <p>Tightening torque: 2 Nm ±10%</p> <p>For robots with protection class IP30 (option 3350-300)</p>  <p>xx210000933</p>
3	<p>Refit the screws.</p>	<p>For robots with protection class IP54 (option 3350-540)</p> <p>For robots with protection type Clean Room (option 3351-1)</p>  <p>xx2100002427</p>



For Clean Room/ IP54 robots

Refitting the top cover and the flange with bearing

	Action	Note
1	<p>For robots with protection type Clean Room:</p> <p>Clean the joints that have been opened and wipe the parts free from particles with spirit on a lint free. See Cut the paint or surface on the robot before replacing parts on page 118</p> <p> Note</p> <p>After all repair work, wipe the Clean Room robot free from particles with spirit on a lint free cloth.</p>	

Continues on next page

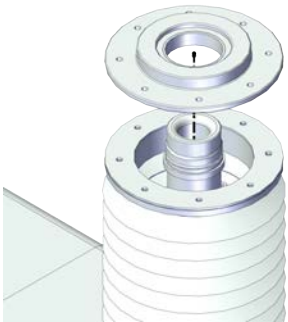
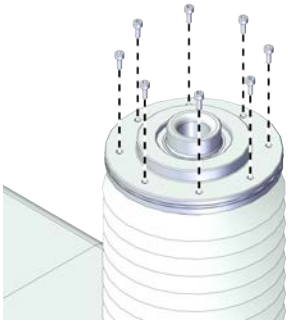
5.7.4 Replacing the axis-4 motor sub-assembly
Continued

	Action	Note
2	<p>For robots with protection class IP54 (option 3350-540) For robots with protection type Clean Room (option 3351-1) Install the flange with bearing to the extension shaft.</p>	 <p>xx2100002402</p>
3	<p>For robots with protection class IP54 (option 3350-540) For robots with protection type Clean Room (option 3351-1) Refit the screws to the flange with bearing.</p>	<p>Screws: Hex socket head cap screw M2.5x6 12.9 Lafre 2C2B/FC6.9 (8 pcs) Tightening torque: 0.8 Nm ±10%</p>  <p>xx2100002401</p>
4	<p>For robots with protection class IP54 (option 3350-540) For robots with protection type Clean Room (option 3351-1) Refit the top cover to the ball screw.</p> <p> Tip</p> <p>The top surface of the cover should be flush with the top end of the ball screw.</p>	 <p>xx2100002399</p>

Continues on next page

5 Repair

5.7.4 Replacing the axis-4 motor sub-assembly

Continued

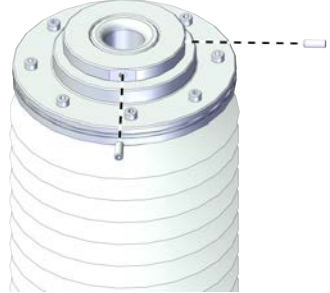

	Action	Note
5	<p>For robots with protection class IP54 (option 3350-540)</p> <p>For robots with protection type Clean Room (option 3351-1)</p> <p>Refit the locking screws.</p>	<p>Screws: Hexagon socket set screws with flat point, ISO 4026 stainless steel M3x8 (2 pcs)</p> <p>Tightening torque: 0.4 Nm \pm10%</p>  <p>xx2100002398</p>

Securing the process hub to outer arm cover

	Action	Note
1	<p>For robots with protection type Clean Room:</p> <p>Clean the joints that have been opened and wipe the parts free from particles with spirit on a lint free. See Cut the paint or surface on the robot before replacing parts on page 118</p> <p> Note</p> <p>After all repair work, wipe the Clean Room robot free from particles with spirit on a lint free cloth.</p>	
2	Insert the process hub from the outer arm cover.	

Continues on next page

5.7.4 Replacing the axis-4 motor sub-assembly
Continued

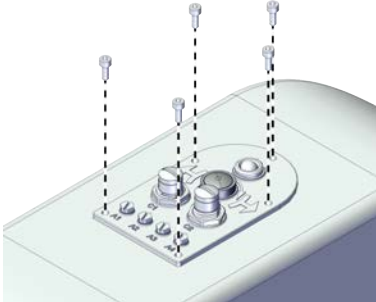
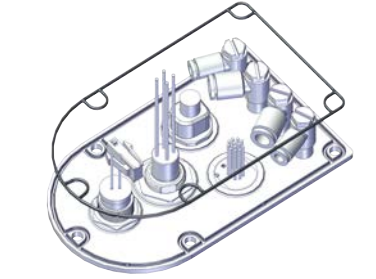
	Action	Note
3	<p>Secure the process hub to the outer arm cover with the screws.</p> <p> Note</p> <p>For robots with protection class IP54 (option 3350-540)</p> <p>For robots with protection type Clean Room (option 3351-1)</p> <p>Check the gasket for the process hub.</p> <p> Tip</p> <p>Replace the gasket if needed.</p> <p> CAUTION</p> <p>Be aware of the cabling that is attached to the cover! The cover can not be removed completely until the connectors are disconnected, as shown in following steps.</p>	<p>Screws: Hex socket head cap screw M4x10 12.9 Lafre 2C2B/FC6.9 (5 pcs)</p> <p>Tightening torque: 2.6 Nm±10%</p> <p>For robots with protection class IP30 (option 3350-300)</p>  <p>xx2100000932</p> <p>For robots with protection class IP54 (option 3350-540)</p> <p>For robots with protection type Clean Room (option 3351-1)</p>  <p>xx2100002438</p>

Concluding procedure

	Action	Note
1	<p>For robots with protection type Clean Room: Seal and paint the joints that have been opened. See Cut the paint or surface on the robot before replacing parts on page 118</p> <p> Note</p> <p>After all repair work, wipe the Clean Room robot free from particles with spirit on a lint free cloth.</p>	
2	Recalibrate the robot.	Calibration is detailed in section Calibration on page 945 .

Continues on next page

5 Repair

5.7.4 Replacing the axis-4 motor sub-assembly

Continued

	Action	Note
3	 DANGER Make sure all safety requirements are met when performing the first test run.	

5.8 Gearboxes

5.8.1 Replacing the axis-1 gear unit sub-assembly

Location of the axis-1 gear unit sub-assembly

The axis-1 gear unit sub-assembly is located as shown in the figure.

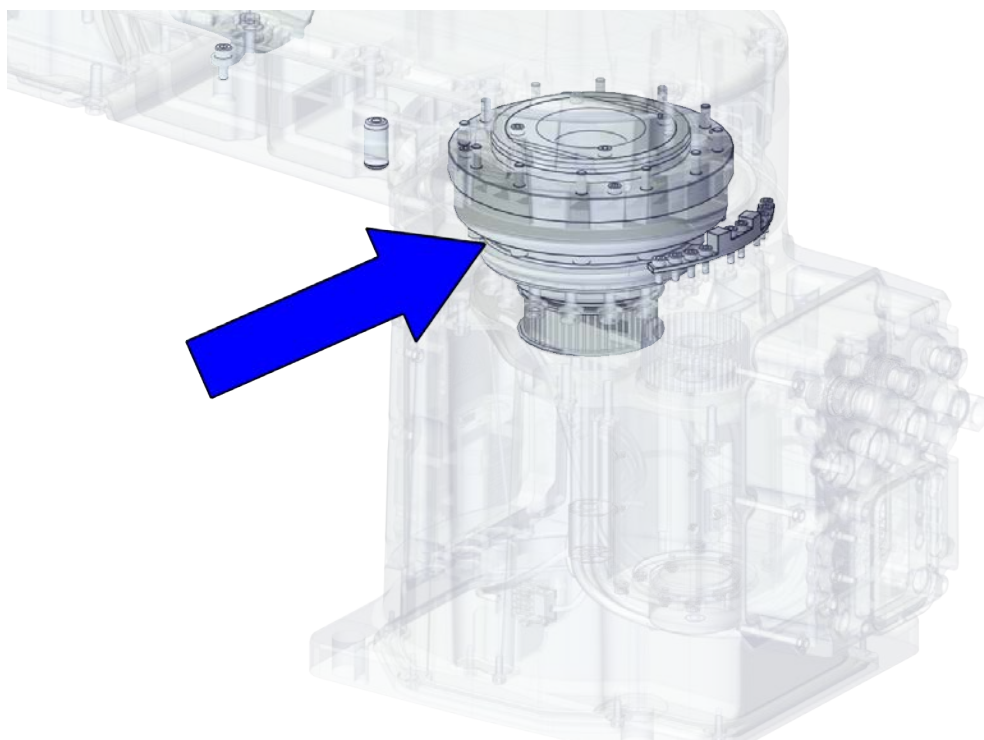

xx2100001027

Required spare parts



Note

The spare part numbers that are listed in the table can be out of date. See the latest spare parts of the IRB 920 via myABB Business Portal, www.abb.com/myABB.

Spare part	Article number	Note
Axis-1 gear unit sub-assembly	3HAC076573-001	Without tube&bolt; flange screw.
Pulley cover	3HAC079523-001	Replace if damaged.
Oil absorbing pad	3HAC079524-001	Replace if damaged.
O-ring	3HAB3772-115	Replace if damaged.

Continues on next page

5 Repair

5.8.1 Replacing the axis-1 gear unit sub-assembly

Continued

Required tools and equipment

Equipment	Article number	Note
Standard toolkit	-	Content is defined in section Standard toolkit on page 996 .
Calibration toolbox, Axis Calibration	3HAC055412-001	Delivered as a set of calibration tools. Required if Axis Calibration is the valid calibration method for the robot.
Belt tension adjustment tool set, axis 1&2	-	Included in the special toolkit 3HAC073070-001. Used to adjust the tension of axis-1&2 timing belts. Special tool for L2
Sonic tension meter	-	Used for measuring the timing belt tension.
Handheld dynamometer	-	Used for measuring the timing belt tension.

Required consumables

Consumable	Article number	Note
Cable straps	-	
Grease	3HAC029132-001	FM 222

Deciding calibration routine

Decide which calibration routine to be used, based on the information in the table. Depending on which routine is chosen, action might be required prior to beginning the repair work of the robot, see the table.



	Action	Note
1	Decide which calibration routine to use for calibrating the robot. <ul style="list-style-type: none"> Reference calibration. External cable packages (DressPack) and tools can stay fitted on the robot. Fine calibration. All external cable packages (DressPack) and tools must be removed from the robot. 	
	If the robot is to be calibrated with reference calibration: Find previous reference values for the axis or create new reference values. These values are to be used after the repair procedure is completed, for calibration of the robot. If no previous reference values exist, and no new reference values can be created, then reference calibration is not possible.	Follow the instructions given in the reference calibration routine on the FlexPendant to create reference values. Creating new values requires possibility to move the robot. Read more about reference calibration for Axis Calibration in Reference calibration routine on page 957 .
	If the robot is to be calibrated with fine calibration: Remove all external cable packages (DressPack) and tools from the robot.	

Continues on next page

Removing the axis-1 gear unit sub-assembly

Use these procedures to remove the axis-1 gear unit sub-assembly.

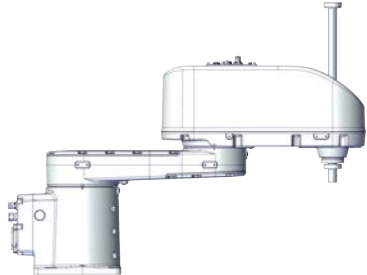
Preparations before removing the axis-1 gear unit sub-assembly

	Action	Note
1	Decide which calibration routine to use, and take actions accordingly prior to beginning the repair procedure.	
2	<p>If there is no enough space for the maintenance work, remove the robot from the wall and place it on the maintenance bracket.</p> <p> CAUTION</p> <p>Do not lay down the robot during the transportation, always keep it straight. If the robot lay down in any situation, the grease may come out from gearbox.</p>	
3	Jog all axes to zero position.	 <p>xx2100000930</p>
4	<p> DANGER</p> <p>Turn off all:</p> <ul style="list-style-type: none"> • electric power supply • hydraulic pressure supply • air pressure supply <p>to the robot, before entering the safeguarded space.</p>	
5	<p> CAUTION</p> <p>For robots with protection type Clean Room Always cut the paint with a knife and grind the paint edge when disassembling parts of the robot! See <i>Cut the paint or surface on the robot before replacing parts on page 118.</i></p>	





Continues on next page

5 Repair

5.8.1 Replacing the axis-1 gear unit sub-assembly

Continued



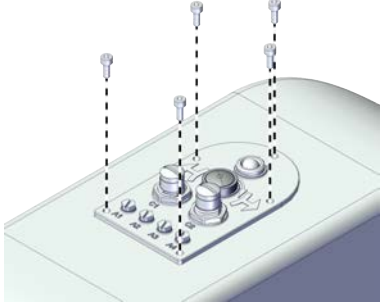
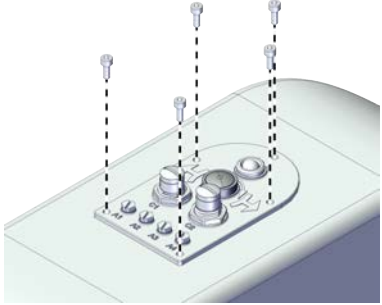

Removing the process hub screws

	Action	Note
1	 DANGER Make sure that all supplies for electrical power, hydraulic pressure, and air pressure are turned off.	
2	 CAUTION For robots with protection type Clean Room Always cut the paint with a knife and grind the paint edge when disassembling parts of the robot! See Cut the paint or surface on the robot before replacing parts on page 118 .	
3	Remove the screws on the process hub.  Note For robots with protection class IP54 (option 3350-540) For robots with protection type Clean Room (option 3351-1) Remove the screws on the process hub and take out the gasket.  Tip Check the gasket and replace it if needed.	For robots with protection class IP30  <small>xx2100000932</small> For robots with protection class IP54 (option 3350-540) For robots with protection type Clean Room (option 3351-1)  <small>xx2100000932</small>
4	Insert the process hub to the outer arm.	

Continues on next page

For Clean Room/ IP54 robots

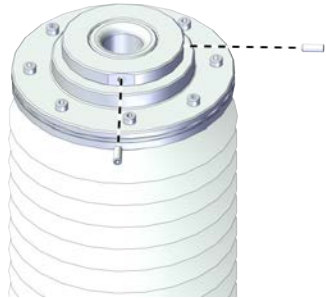
Removing the top cover and the flange with bearing

	Action	Note
1	 DANGER Make sure that all supplies for electrical power, hydraulic pressure, and air pressure are turned off.	
2	 CAUTION For robots with protection type Clean Room Always cut the paint with a knife and grind the paint edge when disassembling parts of the robot! See Cut the paint or surface on the robot before replacing parts on page 118 .	
3	For robots with protection class IP54 (option 3350-540) For robots with protection type Clean Room (option 3351-1) Loose the locking screws.	 <p>xx2100002398</p>
4	For robots with protection class IP54 (option 3350-540) For robots with protection type Clean Room (option 3351-1) Remove the top cover from the ball screw.	 <p>xx2100002399</p>

Continues on next page



5 Repair

5.8.1 Replacing the axis-1 gear unit sub-assembly

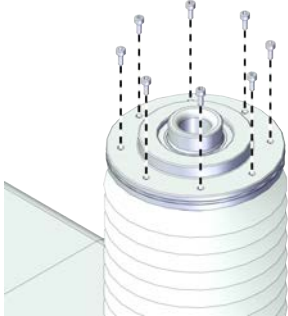
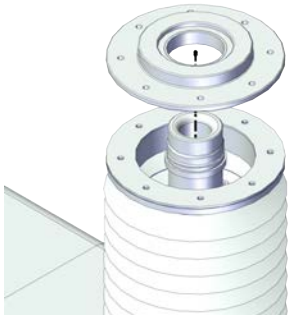
Continued



	Action	Note
5	<p>For robots with protection class IP54 (option 3350-540)</p> <p>For robots with protection type Clean Room (option 3351-1)</p> <p>Remove the screws on the flange with bearing.</p>	 <p>xx2100002401</p>
6	<p>For robots with protection class IP54 (option 3350-540)</p> <p>For robots with protection type Clean Room (option 3351-1)</p> <p>Remove the flange with bearing.</p>	 <p>xx2100002402</p>

Removing the cover of the outer arm



	Action	Note
1	 <p>DANGER</p> <p>Make sure that all supplies for electrical power, hydraulic pressure, and air pressure are turned off.</p>	
2	 <p>CAUTION</p> <p>For robots with protection type Clean Room</p> <p>Always cut the paint with a knife and grind the paint edge when disassembling parts of the robot! See Cut the paint or surface on the robot before replacing parts on page 118.</p>	

Continues on next page

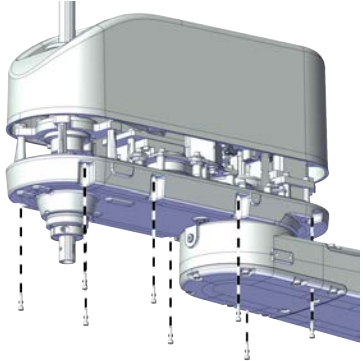
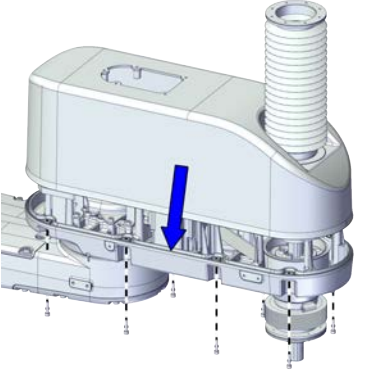
5.8.1 Replacing the axis-1 gear unit sub-assembly
Continued

	Action	Note
3	<p>Remove the screws on the cover of the outer arm and remove the cover.</p> <p> Note</p> <p>For robots with protection class IP54 (option 3350-540) For robots with protection type Clean Room (option 3351-1) Remove the cover with bellow and housing.</p> <p> Note</p> <p>The bellow does not need to be removed separately.</p> <p> Tip</p> <p>Check the gasket and replace it if needed.</p>	<p>For robots with protection class IP30</p>  <p>xx2100000933</p> <p>For robots with protection class IP54 (option 3350-540) For robots with protection type Clean Room (option 3351-1)</p>  <p>xx2100002427</p>

Disconnecting the air hoses, C1 cabling and C2 cabling (if equipped)





	Action	Note
1	<p> DANGER</p> <p>Make sure that all supplies for electrical power, hydraulic pressure, and air pressure are turned off.</p>	
2	<p> CAUTION</p> <p>For robots with protection type Clean Room Always cut the paint with a knife and grind the paint edge when disassembling parts of the robot! See Cut the paint or surface on the robot before replacing parts on page 118.</p>	

Continues on next page

5 Repair

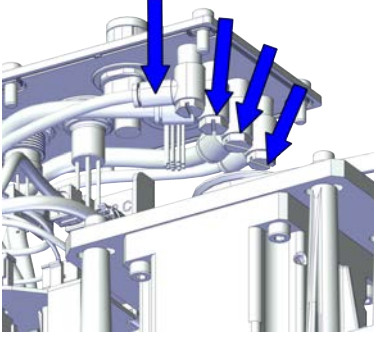
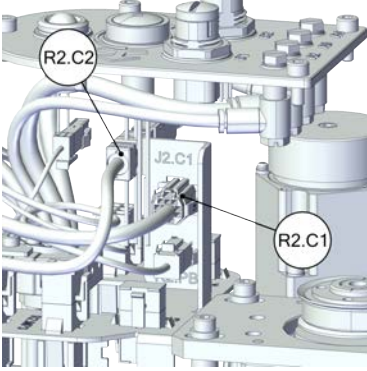
5.8.1 Replacing the axis-1 gear unit sub-assembly

Continued

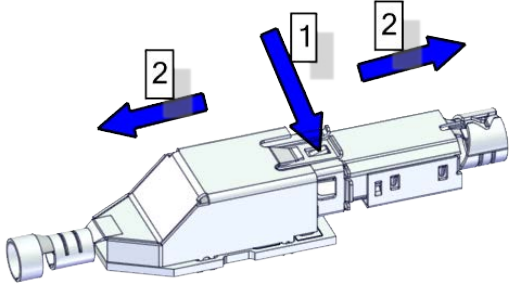
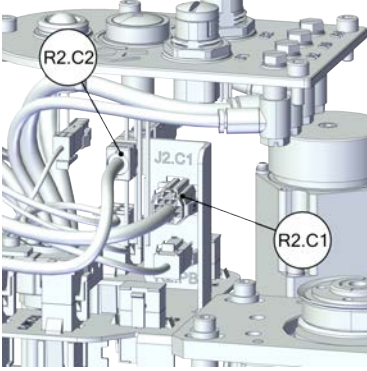

	Action	Note
3	Disconnect the air hoses from the L-shaped connectors.	 xx2100001032
4	For robots with C1 cabling Disconnect the connector. <ul style="list-style-type: none"> • R2.C1 	 xx2100001033
5	For robots with C2 cabling Disconnect the connector. <ul style="list-style-type: none"> • R1.C2 <p> Tip</p> <p>Cut the cable straps for the R1.C2 at the same time.</p> <p> Tip</p> <p>Take photos of the connector and cable position before disconnecting them, to have as a reference when reconnecting.</p> <p> Tip</p> <p>The connector clip has to be pressed (1) and pushed forward (2) to separate the R1.C2 (for C2 cabling).</p>  xx1800002943	 xx2100001033

Continues on next page

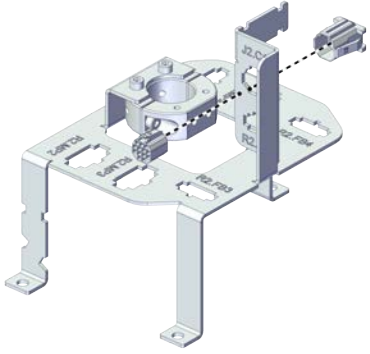
5.8.1 Replacing the axis-1 gear unit sub-assembly
Continued

	Action	Note
6	<p>Snap loose and remove the female head of the connectors from the bracket.</p> <p> Note</p> <p>The harness are not visible due to the cleanness requirements of the illustration. They are still existing inside the cable ferrule in the actual situation.</p>	 <p>xx2100001034</p>

Disconnecting the connectors for axis-2 motor

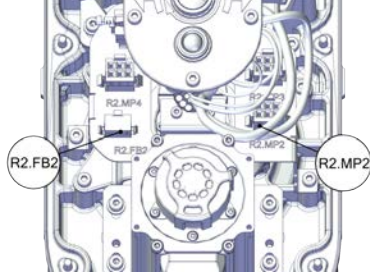
	Action	Note
1	<p> DANGER</p> <p>Make sure that all supplies for electrical power, hydraulic pressure, and air pressure are turned off.</p>	
2	<p> CAUTION</p> <p>For robots with protection type Clean Room Always cut the paint with a knife and grind the paint edge when disassembling parts of the robot! See Cut the paint or surface on the robot before replacing parts on page 118.</p>	
3	<p>Disconnect the connectors.</p> <ul style="list-style-type: none"> • R2.MP2 • R2.FB2 	 <p>xx2100000934</p>

Continues on next page



5 Repair

5.8.1 Replacing the axis-1 gear unit sub-assembly

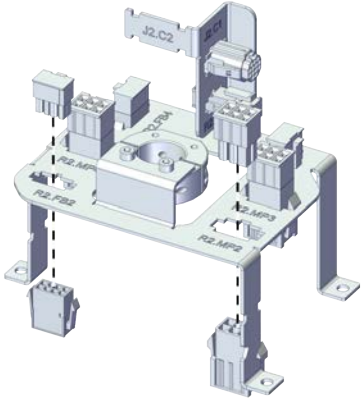
Continued

	Action	Note
4	<p>Snap loose and remove the female head of the connectors from the bracket.</p> <p> Note</p> <p>The harness are not visible due to the cleanness requirements of the illustration. They are still existing inside the cable ferrule in the actual situation.</p>	 <p>xx2100000935</p>

Disconnecting the connectors for axis-3 motor

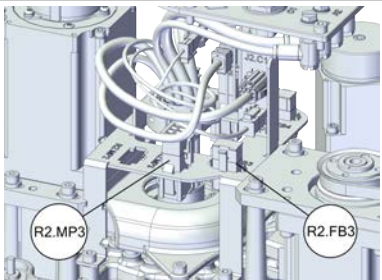
	Action	Note
1	<p> DANGER</p> <p>Make sure that all supplies for electrical power, hydraulic pressure, and air pressure are turned off.</p>	
2	<p> CAUTION</p> <p>For robots with protection type Clean Room</p> <p>Always cut the paint with a knife and grind the paint edge when disassembling parts of the robot!</p> <p>See Cut the paint or surface on the robot before replacing parts on page 118.</p>	
3	<p>Disconnect the connectors.</p> <ul style="list-style-type: none"> • R2.MP3 • R2.FB3 	 <p>xx2100000936</p>



Continues on next page

5.8.1 Replacing the axis-1 gear unit sub-assembly

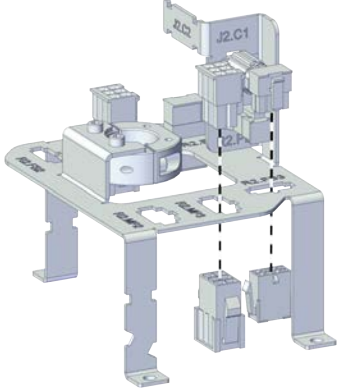
Continued

	Action	Note
4	<p>Snap loose and remove the female head of the connectors from the bracket.</p> <p> Note</p> <p>The harness are not visible due to the cleanness requirements of the illustration. They are still existing inside the cable ferrule in the actual situation.</p>	 <p>xx2100000937</p>

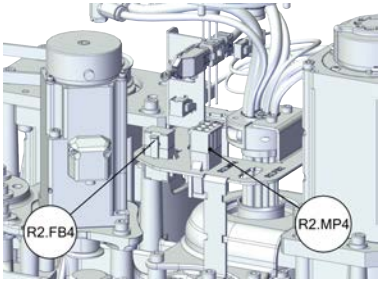
Disconnecting the connectors for axis-4 motor

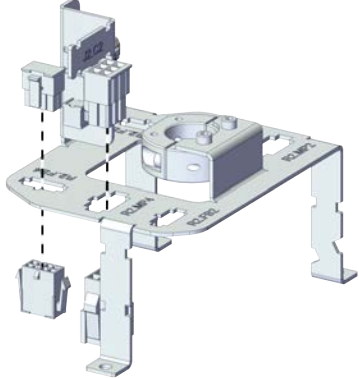
	Action	Note
1	<p>For robots with protection type Clean Room: Clean the joints that have been opened and wipe the parts free from particles with spirit on a lint free. See Cut the paint or surface on the robot before replacing parts on page 118</p> <p> Note</p> <p>After all repair work, wipe the Clean Room robot free from particles with spirit on a lint free cloth.</p>	
2	<p>Disconnect the axis-4 motor connectors.</p> <ul style="list-style-type: none"> • R2.MP4 • R2.FB4 	 <p>xx2100000938</p>
3	<p>Snap loose and remove the female head of the connectors from the bracket.</p> <p> Note</p> <p>The harness are not visible due to the cleanness requirements of the illustration. They are still existing inside the cable ferrule in the actual situation.</p>	 <p>xx2100000939</p>





Continues on next page

5 Repair

5.8.1 Replacing the axis-1 gear unit sub-assembly

Continued

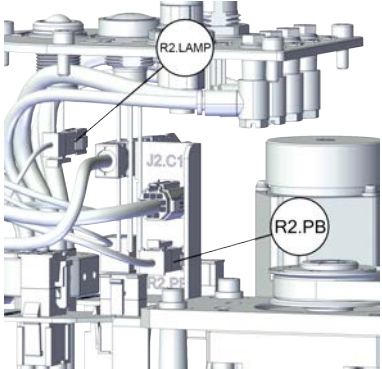
Disconnecting the connector for PB

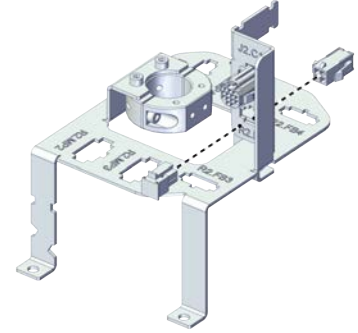



	Action	Note
1	 DANGER Make sure that all supplies for electrical power, hydraulic pressure, and air pressure are turned off.	
2	 CAUTION For robots with protection type Clean Room Always cut the paint with a knife and grind the paint edge when disassembling parts of the robot! See Cut the paint or surface on the robot before replacing parts on page 118 .	
3	Disconnect the connector. <ul style="list-style-type: none"> • R2.PB • R2.LAMP 	 <p>xx2100001030</p>
4	Snap loose and remove the female head of the connector from the bracket.  Note The harness are not visible due to the cleanliness requirements of the illustration. They are still existing inside the cable ferrule in the actual situation.	 <p>xx2100001031</p>

Pull out the process hub



	Action	Note
1	 DANGER Make sure that all supplies for electrical power, hydraulic pressure, and air pressure are turned off.	

Continues on next page

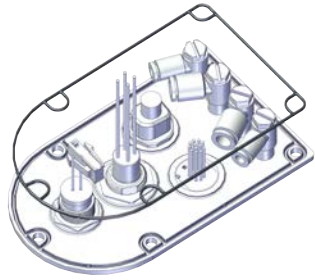
5.8.1 Replacing the axis-1 gear unit sub-assembly
Continued

	Action	Note
2	 CAUTION For robots with protection type Clean Room Always cut the paint with a knife and grind the paint edge when disassembling parts of the robot! See <i>Cut the paint or surface on the robot before replacing parts on page 118.</i>	
3	Take out the process hub.  Note For robots with protection class IP54 (option 3350-540) For robots with protection type Clean Room (option 3351-1) Check the gasket for the process hub.  Tip Replace the gasket if needed.  CAUTION Be aware of the cabling that is attached to the cover! The cover can not be removed completely until the connectors are disconnected, as shown in following steps.	For robots with protection class IP54 (option 3350-540) For robots with protection type Clean Room (option 3351-1)  xx2100002438

Removing the cable ferrule and bracket



	Action	Note
1	 DANGER Make sure that all supplies for electrical power, hydraulic pressure, and air pressure are turned off.	
2	 CAUTION For robots with protection type Clean Room Always cut the paint with a knife and grind the paint edge when disassembling parts of the robot! See <i>Cut the paint or surface on the robot before replacing parts on page 118.</i>	

Continues on next page

5 Repair

5.8.1 Replacing the axis-1 gear unit sub-assembly

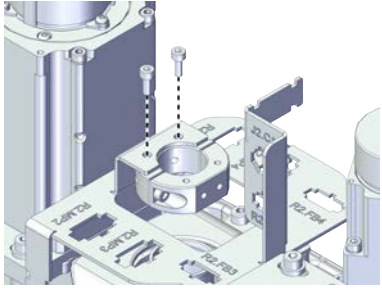
Continued

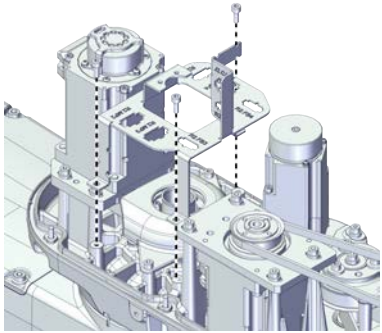
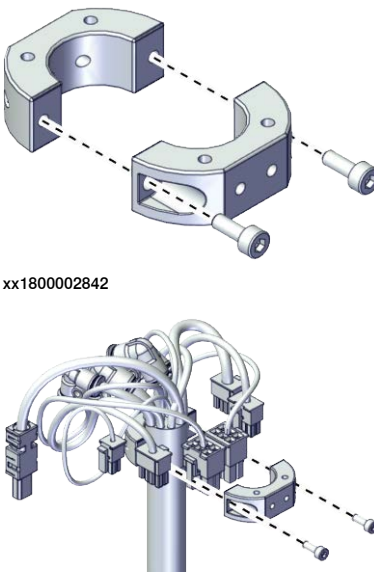

	Action	Note
3	<p>Remove the screws on the bracket to the cable ferrule to release the cable ferrule with cable.</p> <p> Note</p> <p>The harness are not visible due to the cleanness requirements of the illustration. They are still existing inside the cable ferrule in the actual situation.</p>	 <p>xx2100000940</p>
4	<p>Remove the screws on the bracket.</p> <p> Note</p> <p>The harness are not visible due to the cleanness requirements of the illustration. They are still existing inside the cable ferrule in the actual situation.</p>	 <p>xx2100000941</p>
5	<p>Remove the screws on the cable ferrule and take the cable ferrule out.</p>	 <p>xx1800002842</p> <p>xx1800002849</p>

Removing the axis-1 cover



	Action	Note
1	<p> DANGER</p> <p>Make sure that all supplies for electrical power, hydraulic pressure, and air pressure are turned off.</p>	

Continues on next page

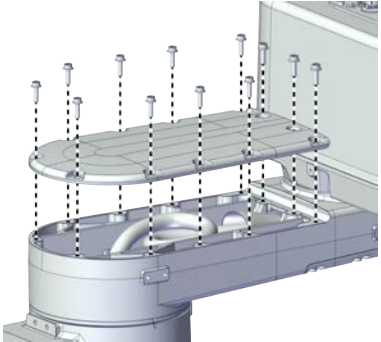
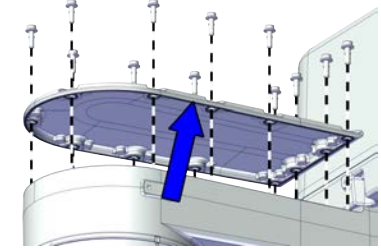
5.8.1 Replacing the axis-1 gear unit sub-assembly
Continued

	Action	Note
2	 CAUTION For robots with protection type Clean Room Always cut the paint with a knife and grind the paint edge when disassembling parts of the robot! See <i>Cut the paint or surface on the robot before replacing parts on page 118.</i>	
3	Remove the screws.	For robots with protection class IP30 (option 3350-300)
4	Remove the cover.  Note For robots with protection class IP54 (option 3350-540) For robots with protection type Clean Room (option 3351-1) Remove the cover and check the gasket.  Tip Replace the gasket if needed.	 <p>xx2100000942</p> For robots with protection class IP54 (option 3350-540) For robots with protection type Clean Room (option 3351-1)  <p>xx2100002428</p>

Removing the axis-2 cover



	Action	Note
1	 DANGER Make sure that all supplies for electrical power, hydraulic pressure, and air pressure are turned off.	
2	 CAUTION For robots with protection type Clean Room Always cut the paint with a knife and grind the paint edge when disassembling parts of the robot! See <i>Cut the paint or surface on the robot before replacing parts on page 118.</i>	

Continues on next page



5 Repair

5.8.1 Replacing the axis-1 gear unit sub-assembly

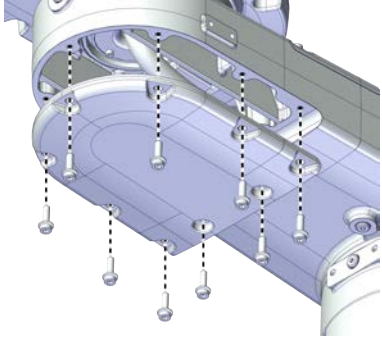
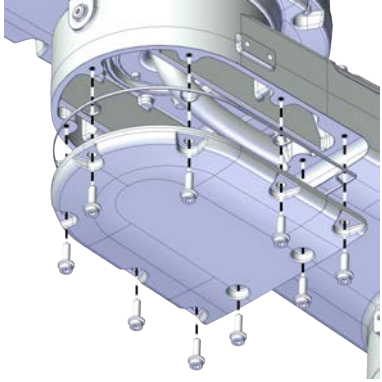
Continued





	Action	Note
3	Remove the screws.	For robots with protection class IP30 (option 3350-300)
4	Remove the cover.  Note For robots with protection class IP54 (option 3350-540) For robots with protection type Clean Room (option 3351-1) Remove the cover and check the gasket.  Tip Replace the gasket if needed.	 xx2100000943 For robots with protection class IP54 (option 3350-540) For robots with protection type Clean Room (option 3351-1)  xx2100002451

Removing the SMB cover

	Action	Note
1	 DANGER Make sure that all supplies for electrical power, hydraulic pressure, and air pressure are turned off.	
2	 ELECTROSTATIC DISCHARGE (ESD) The unit is sensitive to ESD. Before handling the unit read the safety information in section The unit is sensitive to ESD on page 49 .	

Continues on next page

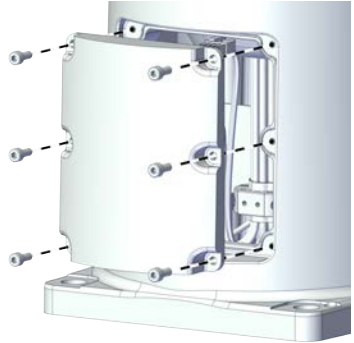
5.8.1 Replacing the axis-1 gear unit sub-assembly
Continued

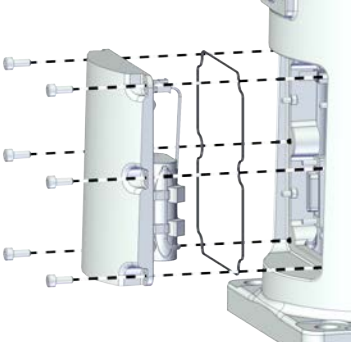
	Action	Note
3	<p> CAUTION</p> <p>For robots with protection type Clean Room Always cut the paint with a knife and grind the paint edge when disassembling parts of the robot! See <i>Cut the paint or surface on the robot before replacing parts on page 118.</i></p>	
4	<p>Remove the screws on the SMB cover to the base.</p> <p> Note</p> <p>For robots with protection type Clean Room (option 3351-1) Remove the stainless screws on the SMB cover to the base.</p>	<p>For robots with protection class IP30 (option 3350-300)</p> 
5	<p>Pull the SMB cover with the SMB unit assembly out together.</p> <p> Note</p> <p>For robots with protection class IP54 (option 3350-540) For robots with protection type Clean Room (option 3351-1) Check the gasket for the SMB cover.</p> <p> Tip</p> <p>Replace the gasket if needed.</p>	<p>xx2100000944</p> <p>For robots with protection class IP54 (option 3350-540) For robots with protection type Clean Room (option 3351-1)</p>  <p>xx2100002433</p>

Disconnecting the SMB cabling



	Action	Note
1	<p> DANGER</p> <p>Make sure that all supplies for electrical power, hydraulic pressure, and air pressure are turned off.</p>	

Continues on next page



5 Repair

5.8.1 Replacing the axis-1 gear unit sub-assembly

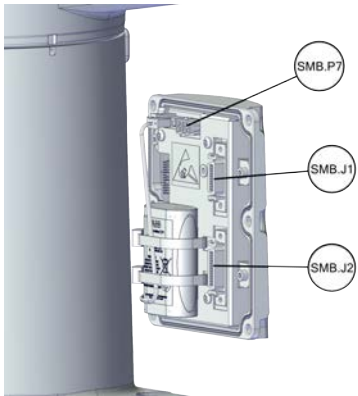
Continued



	Action	Note
2	 ELECTROSTATIC DISCHARGE (ESD) The unit is sensitive to ESD. Before handling the unit read the safety information in section The unit is sensitive to ESD on page 49 .	
3	 CAUTION For robots with protection type Clean Room Always cut the paint with a knife and grind the paint edge when disassembling parts of the robot! See Cut the paint or surface on the robot before replacing parts on page 118 .	
4	Cut the strips.	
5	Disconnect the connectors. <ul style="list-style-type: none"> • SMB.P7 • SMB.J1 • SMB.J2  Tip Take photos of the connector and cable position before disconnecting them, to have as a reference when reconnecting.	 xx2100000945

Removing the base plate/ rear plate

	Action	Note
1	 DANGER Make sure that all supplies for electrical power, hydraulic pressure, and air pressure are turned off.	
2	 CAUTION For robots with protection type Clean Room Always cut the paint with a knife and grind the paint edge when disassembling parts of the robot! See Cut the paint or surface on the robot before replacing parts on page 118 .	
3	Remove the screws on the base to the ground.	
4	Lay down the robot.	

Continues on next page

5.8.1 Replacing the axis-1 gear unit sub-assembly
Continued

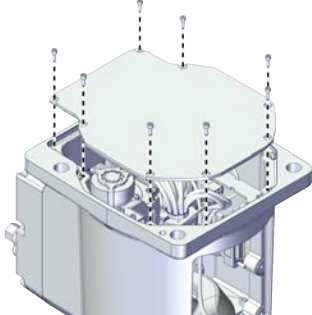
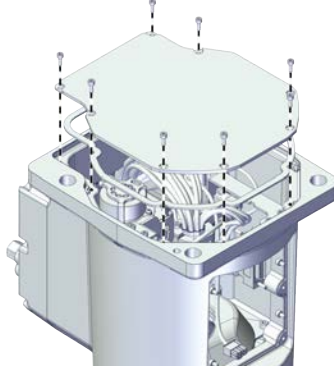

	Action	Note
5	For robot with rear outlet cable version, remove the screws on the base plate.	For rear outlet cable version:
6	<p>Remove the base plate.</p> <p> Note</p> <p>For robots with protection class IP54 (option 3350-540)</p> <p>For robots with protection type Clean Room (option 3351-1)</p> <p>Check the gasket for the base plate.</p> <p> Tip</p> <p>Replace the gasket if needed.</p>	<p>For robots with protection class IP30 (option 3350-300)</p>  <p>xx2100000946</p> <p>For robots with protection class IP54 (option 3350-540)</p> <p>For robots with protection type Clean Room (option 3351-1)</p>  <p>xx2100002434</p>

Continues on next page



5 Repair

5.8.1 Replacing the axis-1 gear unit sub-assembly

Continued

	Action	Note
7	For robot with underneath outlet cable version, remove the screws on the rear plate.	For underneath outlet cable version: For robots with protection class IP30 (option 3350-300)
8	Remove the rear plate.  Note For robots with protection class IP54 (option 3350-540) For robots with protection type Clean Room (option 3351-1) Check the gasket for the rear plate.  Tip Replace the gasket if needed.	

Releasing the base bracket



	Action	Note
1	 DANGER Make sure that all supplies for electrical power, hydraulic pressure, and air pressure are turned off.	
2	 CAUTION For robots with protection type Clean Room Always cut the paint with a knife and grind the paint edge when disassembling parts of the robot! See Cut the paint or surface on the robot before replacing parts on page 118 .	

Continues on next page

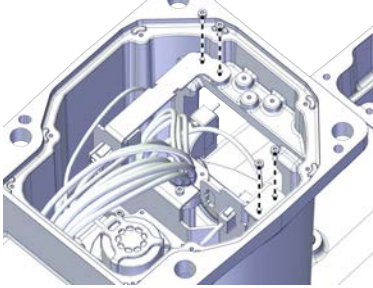
5.8.1 Replacing the axis-1 gear unit sub-assembly
Continued

	Action	Note
3	Remove the screws on the base bracket to the base.	 xx2100000948

Disconnecting the grounding cable connectors

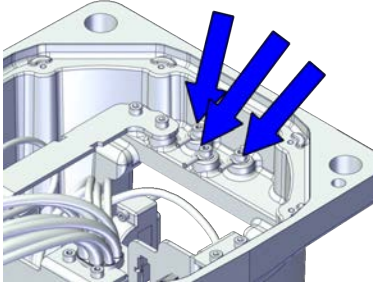
	Action	Note
1	 DANGER Make sure that all supplies for electrical power, hydraulic pressure, and air pressure are turned off.	
2	 CAUTION For robots with protection type Clean Room Always cut the paint with a knife and grind the paint edge when disassembling parts of the robot! See Cut the paint or surface on the robot before replacing parts on page 118 .	
3	Remove the three grounding cables from the bracket by unscrew the screws.	 xx2100000947

Disconnecting the connectors for axis-1 motor



	Action	Note
1	 DANGER Make sure that all supplies for electrical power, hydraulic pressure, and air pressure are turned off.	

Continues on next page

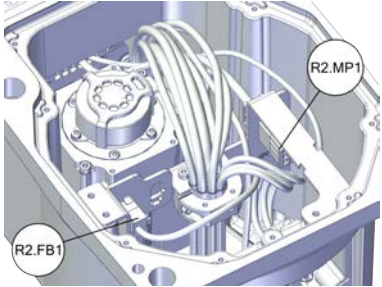

5 Repair

5.8.1 Replacing the axis-1 gear unit sub-assembly

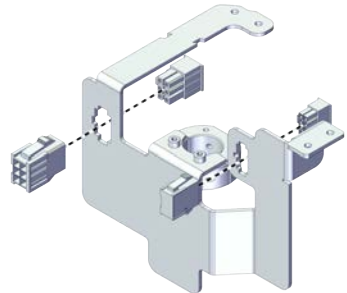
Continued

	Action	Note
2	 CAUTION For robots with protection type Clean Room Always cut the paint with a knife and grind the paint edge when disassembling parts of the robot! See <i>Cut the paint or surface on the robot before replacing parts on page 118.</i>	
3	Disconnect the connectors. <ul style="list-style-type: none"> • R2.MP1 • R2.FB1 	 xx2100000949
4	Snap loose and remove the female head of the connectors from the bracket.  Note The harness are not visible due to the cleanliness requirements of the illustration. They are still existing inside the cable ferrule in the actual situation.	 xx2100000950

Removing the bracket



	Action	Note
1	 DANGER Make sure that all supplies for electrical power, hydraulic pressure, and air pressure are turned off.	
2	 CAUTION For robots with protection type Clean Room Always cut the paint with a knife and grind the paint edge when disassembling parts of the robot! See <i>Cut the paint or surface on the robot before replacing parts on page 118.</i>	

Continues on next page

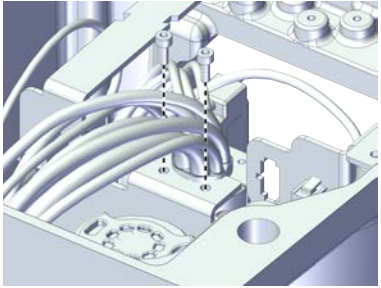
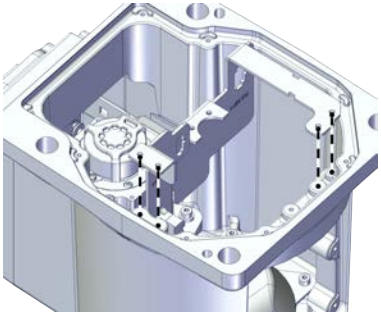
5.8.1 Replacing the axis-1 gear unit sub-assembly
Continued

	Action	Note
3	Release the cable ferrule from the bracket.	 <p>xx2100000951</p>
4	Remove the bracket.	 <p>xx2100000952</p>

Removing the main harness from the axis -2 gearbox position



	Action	Note
1	 <p>DANGER</p> <p>Make sure that all supplies for electrical power, hydraulic pressure, and air pressure are turned off.</p>	
2	 <p>CAUTION</p> <p>For robots with protection type Clean Room Always cut the paint with a knife and grind the paint edge when disassembling parts of the robot! See Cut the paint or surface on the robot before replacing parts on page 118.</p>	

Continues on next page



5 Repair

5.8.1 Replacing the axis-1 gear unit sub-assembly

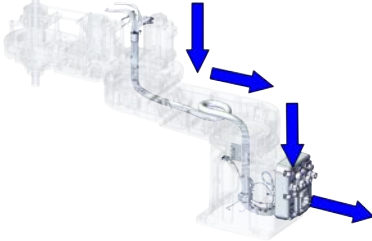
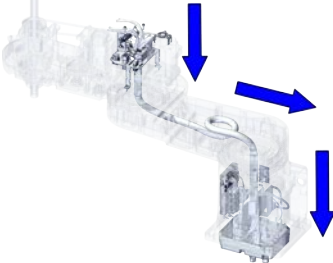
Continued

	Action	Note
3	<p>Pull the internal harness out of the outer arm from the centre of the axis-2 gearbox.</p> <p> Tip</p> <p>Wrap the connectors with the masking tape.</p> <p> Tip</p> <p>Take photos of the connector and cable position before disconnecting them, to have as a reference when reconnecting.</p>	<p>For rear outlet cable version:</p>  <p>xx2100000954</p> <p>For underneath outlet cable version:</p>  <p>xx2100001203</p>

Removing the main harness from the axis -1 gearbox position



	Action	Note
1	<p> DANGER</p> <p>Make sure that all supplies for electrical power, hydraulic pressure, and air pressure are turned off.</p>	
2	<p> CAUTION</p> <p>For robots with protection type Clean Room</p> <p>Always cut the paint with a knife and grind the paint edge when disassembling parts of the robot!</p> <p>See Cut the paint or surface on the robot before replacing parts on page 118.</p>	

Continues on next page

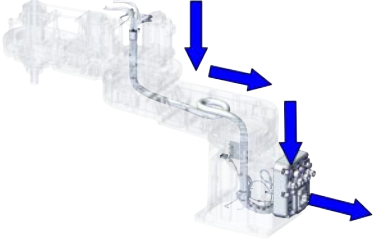
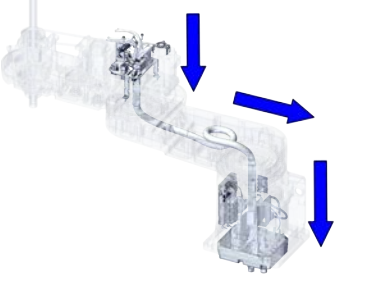
5.8.1 Replacing the axis-1 gear unit sub-assembly
Continued

	Action	Note
3	<p>Pull the internal harness out of the inner arm from the sleeve of the axis-1 gearbox.</p> <p> Tip</p> <p>Wrap the connectors with the masking tape.</p>	<p>For rear outlet cable version:</p>  <p>xx2100000954</p> <p>For underneath outlet cable version:</p>  <p>xx2100001203</p>

Removing the main harness



	Action	Note
1	<p> DANGER</p> <p>Make sure that all supplies for electrical power, hydraulic pressure, and air pressure are turned off.</p>	
2	<p> CAUTION</p> <p>For robots with protection type Clean Room</p> <p>Always cut the paint with a knife and grind the paint edge when disassembling parts of the robot! See Cut the paint or surface on the robot before replacing parts on page 118.</p>	

Continues on next page

5 Repair

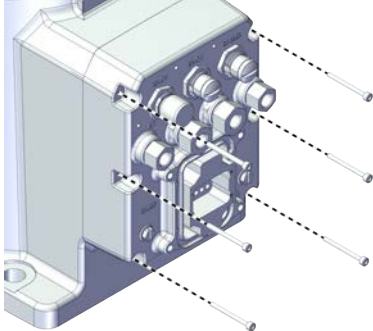
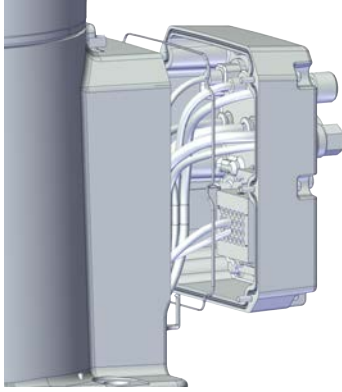

5.8.1 Replacing the axis-1 gear unit sub-assembly

Continued

	Action	Note
3	For robot with rear outlet cable version, remove the screws on the main harness to the base.	For rear outlet cable version:
4	<p>Remove the main harness.</p> <p> Note</p> <p>For robots with protection class IP54 (option 3350-540)</p> <p>For robots with protection type Clean Room (option 3351-1)</p> <p>Check the gasket for the main harness.</p> <p> Tip</p> <p>Replace the gasket if needed.</p>	<p>For robots with protection class IP30 (option 3350-300)</p>  <p>xx2100000953</p> <p>For robots with protection class IP54 (option 3350-540)</p> <p>For robots with protection type Clean Room (option 3351-1)</p>  <p>xx2100002436</p>

Continues on next page

5.8.1 Replacing the axis-1 gear unit sub-assembly
Continued

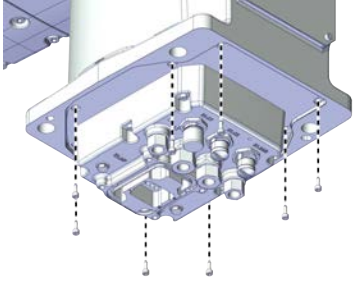
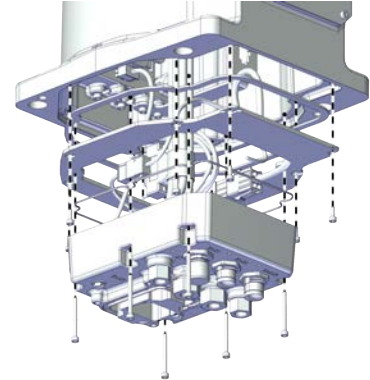
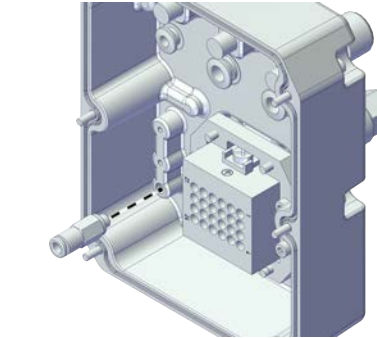
	Action	Note
5	For robot with underneath outlet cable version, remove the screws on the main harness assembly.	For underneath outlet cable version:
6	<p>Remove the main harness assembly.</p> <p> Note</p> <p>For robots with protection class IP54 (option 3350-540)</p> <p>For robots with protection type Clean Room (option 3351-1)</p> <p>Check the gasket for the main harness assembly.</p> <p> Tip</p> <p>Replace the gasket if needed.</p> <p> Note</p> <p>Remove the bottom plate from the main harness if needed.</p>	<p>For robots with protection class IP30 (option 3350-300)</p>  <p>xx2100001204</p> <p>For robots with protection class IP54 (option 3350-540)</p> <p>For robots with protection type Clean Room (option 3351-1)</p>  <p>xx2100002437</p>
7	<p>For robots with protection type Clean Room (option 3351-1)</p> <p>Remove the one way valve by unscrewing it.</p>	 <p>xx2200000281</p>

Removing the pulley protection cover

	Action	Note
1	<p> DANGER</p> <p>Make sure that all supplies for electrical power, hydraulic pressure, and air pressure are turned off.</p>	

Continues on next page



5 Repair

5.8.1 Replacing the axis-1 gear unit sub-assembly

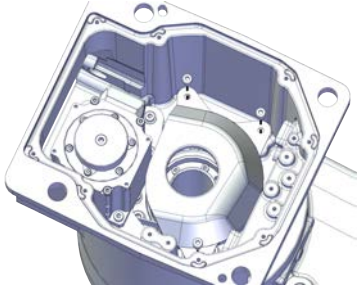
Continued

	Action	Note
2	 CAUTION For robots with protection type Clean Room Always cut the paint with a knife and grind the paint edge when disassembling parts of the robot! See Cut the paint or surface on the robot before replacing parts on page 118 .	
3	Remove the screws on the pulley protection cover to the base.	 xx2100001037
4	Remove the pulley protection cover.	

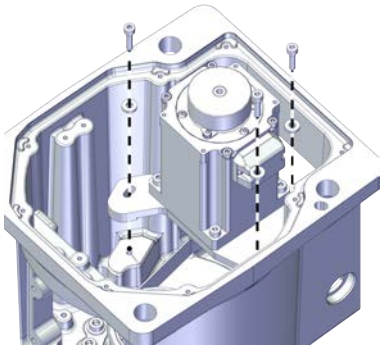

Removing the axis-1 motor sub-assembly

	Action	Note
1	 DANGER Make sure that all supplies for electrical power, hydraulic pressure, and air pressure are turned off.	
2	 CAUTION For robots with protection type Clean Room Always cut the paint with a knife and grind the paint edge when disassembling parts of the robot! See Cut the paint or surface on the robot before replacing parts on page 118 .	
3	Remove the screws and washers.	 xx2100001038
4	Remove the motor.	



Continues on next page

5.8.1 Replacing the axis-1 gear unit sub-assembly
Continued

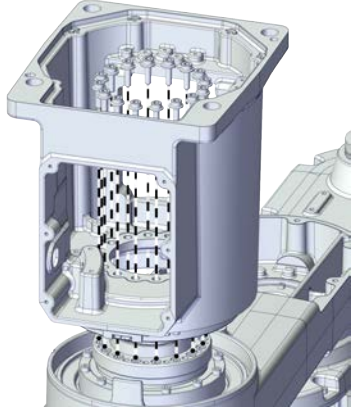
Removing the base from the axis-1 gear unit sub-assembly

	Action	Note
1	 DANGER Make sure that all supplies for electrical power, hydraulic pressure, and air pressure are turned off.	
2	 CAUTION For robots with protection type Clean Room Always cut the paint with a knife and grind the paint edge when disassembling parts of the robot! See Cut the paint or surface on the robot before replacing parts on page 118 .	
3	Remove the screws and washers on the base to the axis-1 gear unit.	 xx2100001039
4	Remove the base.	

Removing the axis-1 gear unit sub-assembly



	Action	Note
1	 DANGER Make sure that all supplies for electrical power, hydraulic pressure, and air pressure are turned off.	
2	 CAUTION For robots with protection type Clean Room Always cut the paint with a knife and grind the paint edge when disassembling parts of the robot! See Cut the paint or surface on the robot before replacing parts on page 118 .	

Continues on next page

5 Repair

5.8.1 Replacing the axis-1 gear unit sub-assembly

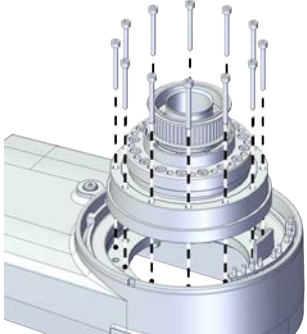

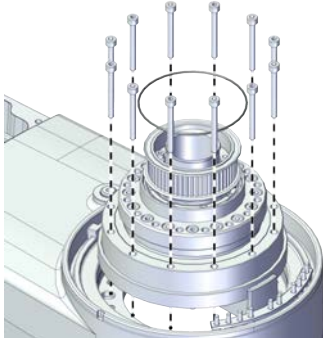
Continued

	Action	Note
3	Remove the screws on the gear to the inner arm.	<p>For robots with protection class IP30 (option 3350-300)</p>  <p>xx2100001130</p> <p>For robots with protection class IP54 (option 3350-540) For robots with protection type Clean Room (option 3351-1) Remove the gear unit and the O-ring through the cable slightly.</p> <p> Tip</p> <p>Check the O-ring and replace it if needed.</p> <p> Tip</p> <p>Wrap the connectors with the masking tape.</p>  <p>xx2100002440</p>
4	Remove the gear unit.	

Refitting the axis-1 gear unit sub-assembly





Use these procedures to refit the axis-1 gear unit sub-assembly.

Refitting the axis-1 gear unit sub-assembly to the inner arm

	Action	Note
1	<p>For robots with protection type Clean Room: Clean the joints that have been opened and wipe the parts free from particles with spirit on a lint free. See Cut the paint or surface on the robot before replacing parts on page 118</p> <p> Note</p> <p>After all repair work, wipe the Clean Room robot free from particles with spirit on a lint free cloth.</p>	
2	<p> CAUTION</p> <p>Whenever parting/mating motor and gearbox, the gears may be damaged if excessive force is used.</p>	

Continues on next page

5.8.1 Replacing the axis-1 gear unit sub-assembly
Continued

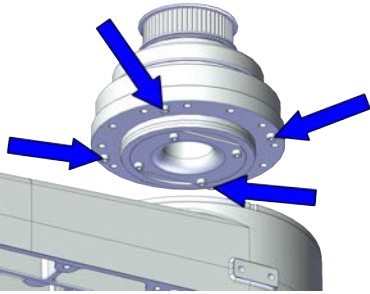
	Action	Note
3	<p>Refit the gear unit according to the location screws through the cable.</p> <p> Note</p> <p>For robots with protection class IP54 (option 3350-540) For robots with protection type Clean Room (option 3351-1) Refit the gear unit and the O-ring according to the location pin through the cable.</p> <p> Tip</p> <p>Check the O-ring and replace it if needed.</p> <p> Tip</p> <p>When the gear unit is in the right position, you can hear a clear "Click".</p> <p> Tip</p> <p>Wrap the connectors with the masking tape.</p>	 <p>xx2100001131</p>

Continues on next page

5 Repair

5.8.1 Replacing the axis-1 gear unit sub-assembly

Continued

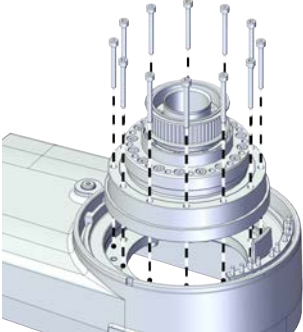
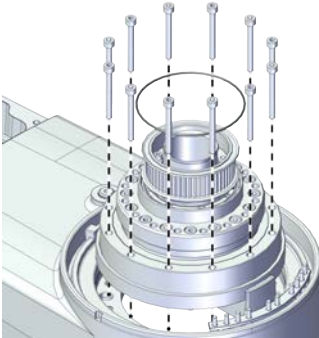
	Action	Note
4	Refit the screws.	<p>Screws: Hex socket head cap screw M4x35 12.9 Lafre 2C2B/FC6.9 (12 pcs) Tightening torque: 4.7 Nm \pm3% For robots with protection class IP30 (option 3350-300)</p>  <p>xx2100001130</p> <p>For robots with protection class IP54 (option 3350-540) For robots with protection type Clean Room (option 3351-1)</p>  <p>xx2100002440</p>

Refitting the base

	Action	Note
1	<p>For robots with protection type Clean Room: Clean the joints that have been opened and wipe the parts free from particles with spirit on a lint free. See Cut the paint or surface on the robot before replacing parts on page 118</p> <p> Note</p> <p>After all repair work, wipe the Clean Room robot free from particles with spirit on a lint free cloth.</p>	

Continues on next page

5.8.1 Replacing the axis-1 gear unit sub-assembly
Continued

	Action	Note
2	Refit the base to the axis-1 gearbox as the illustration.	Screws: Hex socket head cap screw M5x16 12.9 Lafre 2C2B/FC6.9 (16 pcs) Washers: Plain washer 11x5.3x1.2 Steel (16 pcs) Tightening torque: 8.5 Nm±10%
3	Refit the screws.	

Refitting the axis-1 motor sub-assembly



	Action	Note
1	For robots with protection type Clean Room: Clean the joints that have been opened and wipe the parts free from particles with spirit on a lint free. See Cut the paint or surface on the robot before replacing parts on page 118	
	 Note After all repair work, wipe the Clean Room robot free from particles with spirit on a lint free cloth.	
2	Put the timing belt into the pulley on the gear.	

Continues on next page

5 Repair

5.8.1 Replacing the axis-1 gear unit sub-assembly

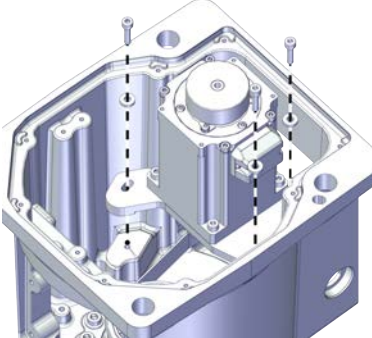
Continued

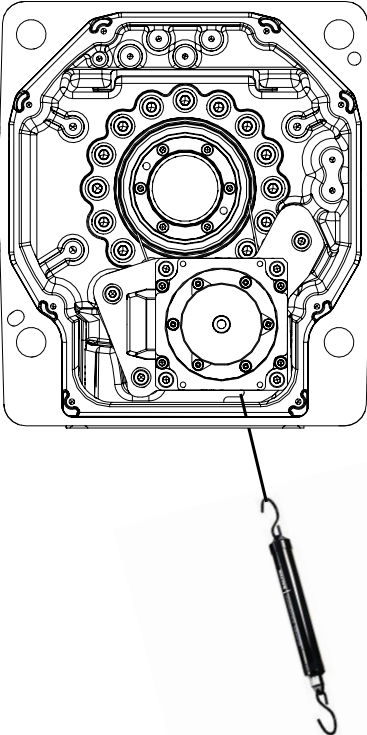

	Action	Note
3	Refit the motor and refit the timing belt to the motor. Ensure that the belt runs correctly in the grooves.	Screws: Hex socket head cap screw M4x16 12.9 Lafre 2C2B/FC6.9 (3 pcs) Washers: Plain washer machining 4.2x9x2 steel (3 pcs) Tightening torque: 2.8 Nm \pm 10%
4	Refit the screws and washers without fully tightened.	 <p>xx2100001038</p> <p>Timing belt A1: 3HAC070449-001</p>
5	Hang a strap to the hook on the motor.	
6	Use a handheld dynamometer hooking to the strap and pull the dynamometer to make the tension falling in the allowed force range.  Note During the measurement, make sure that all interferences that may affect the force are removed. Pay attention to the force application direction.	Used belt: 51.1 New belt:90  <p>xx2100001043</p>

Continues on next page

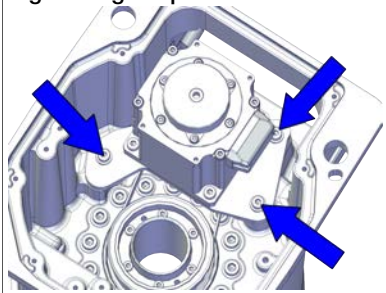
5.8.1 Replacing the axis-1 gear unit sub-assembly
Continued

	Action	Note
7	Fasten the screws to the recommended tightening torque.	Tightening torque: 2.8 Nm ±10%  xx2100001044
8	Use a sonic tension meter to measure the timing belt tension.	Used belt: 308 New belt:250
9	If the timing belt tension does not meet the requirement, loosen the motor screws and readjust.	

Refitting the pulley protection cover

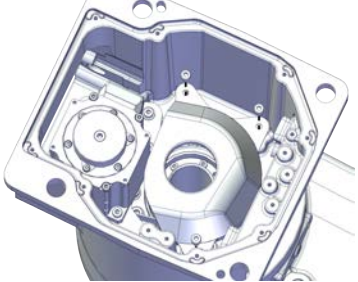
	Action	Note
1	 DANGER Make sure that all supplies for electrical power, hydraulic pressure, and air pressure are turned off.	
2	 CAUTION For robots with protection type Clean Room Always cut the paint with a knife and grind the paint edge when disassembling parts of the robot! See Cut the paint or surface on the robot before replacing parts on page 118.	
3	Refit the pulley protection cover.	Screws: Hex socket head cap screw M4x10 12.9 Lafre 2C2B/FC6.9 (8 pcs) Tightening torque: 0.8 Nm
4	Secure the screws on the pulley protection cover to the base.	 xx2100001037





Continues on next page

5 Repair

5.8.1 Replacing the axis-1 gear unit sub-assembly

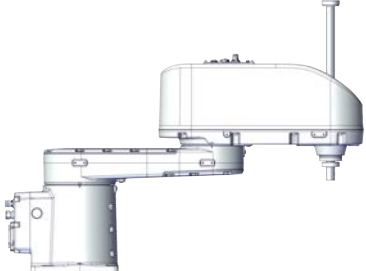



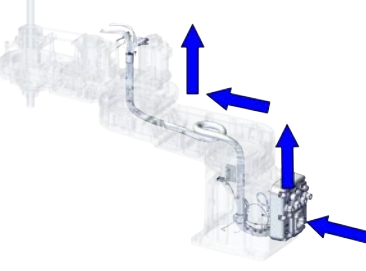
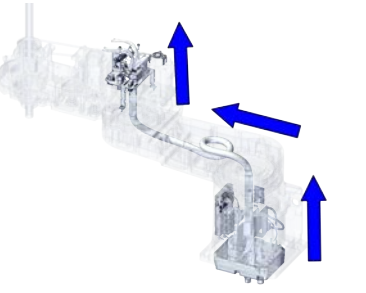

Continued

Inserting the main harness through the axis -1 gearbox position

	Action	Note
1	<p>For robots with protection type Clean Room: Clean the joints that have been opened and wipe the parts free from particles with spirit on a lint free. See Cut the paint or surface on the robot before replacing parts on page 118</p> <p> Note</p> <p>After all repair work, wipe the Clean Room robot free from particles with spirit on a lint free cloth.</p>	
2	<p>Make sure that the robot is at zero position.</p>	 <p>xx2100000930</p>
3	<p>Insert the internal harness into the inner arm through the sleeve of the axis-1 gearbox from the base.</p> <p> Tip</p> <p>Wrap the connectors with the masking tape.</p> <p> Tip</p> <p>The air hoses should face the axis-1 motor.</p> <p> CAUTION</p> <p>Make sure that no cables or hoses are twisted or strained. Reroute if necessary.</p>	<p>For rear outlet cable version:</p>  <p>xx2100000955</p> <p>For underneath outlet cable version:</p>  <p>xx2100001206</p>

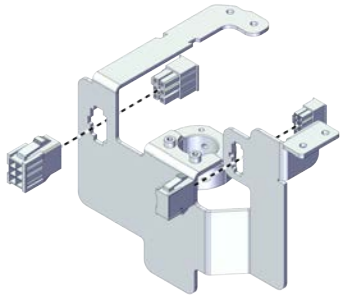
Continues on next page

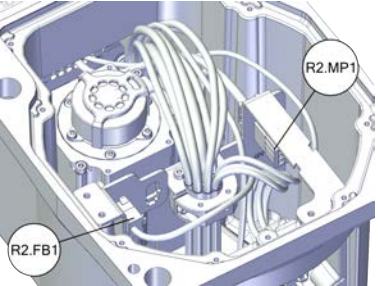
Reconnecting the connectors for axis-1 motor

	Action	Note
1	<p>For robots with protection type Clean Room: Clean the joints that have been opened and wipe the parts free from particles with spirit on a lint free. See Cut the paint or surface on the robot before replacing parts on page 118</p> <p> Note</p> <p>After all repair work, wipe the Clean Room robot free from particles with spirit on a lint free cloth.</p>	
2	<p>Insert the female head of the connectors to the bracket accordingly.</p> <p> Tip</p> <p>The mistake proofing measure has been applied to the connectors, the connectors may be damaged if excessive force is used.</p> <p> Note</p> <p>The harness are not visible due to the cleanness requirements of the illustration. They are still existing inside the cable ferrule in the actual situation.</p>	 <p>xx2100000950</p>
3	<p>Reconnect the connectors.</p> <ul style="list-style-type: none"> • R2.MP1 • R2.FB1 <p> Tip</p> <p>See the number markings on the connectors for help to find the corresponding connector.</p>	 <p>xx2100000949</p>
4	<p>Route the cabling behind the axis-1 motor.</p> <p> CAUTION</p> <p>Correct cable routing is highly important. If the cables are routed and secured incorrectly the cables can be damaged.</p>	



Continues on next page

5 Repair

5.8.1 Replacing the axis-1 gear unit sub-assembly

Continued

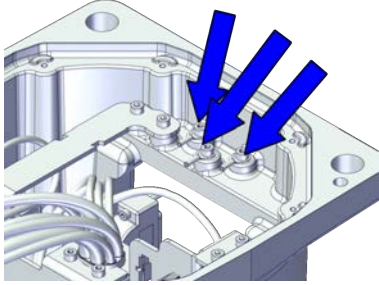
Reconnecting the grounding cable connectors



	Action	Note
1	<p>For robots with protection type Clean Room: Clean the joints that have been opened and wipe the parts free from particles with spirit on a lint free. See Cut the paint or surface on the robot before replacing parts on page 118</p> <p> Note</p> <p>After all repair work, wipe the Clean Room robot free from particles with spirit on a lint free cloth.</p>	
2	<p>Secure the three grounding cables to the bracket with the screw.</p>	<p>Screws: Hex socket head cap screw M3x5 12.9 Lafre 2C2B/FC6.9 (3 pcs) Tightening torque: 1.5 Nm \pm10%</p>  <p>xx2100000947</p>
3	<p>Route and secure the cabling with cable straps if needed.</p> <p> CAUTION</p> <p>Correct cable routing is highly important. If the cables are routed and secured incorrectly the cables can be damaged.</p>	

Refitting the cable ferrule in the base



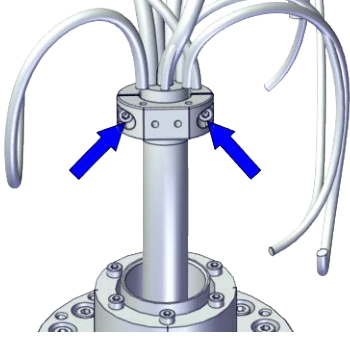

	Action	Note
1	<p>For robots with protection type Clean Room: Clean the joints that have been opened and wipe the parts free from particles with spirit on a lint free. See Cut the paint or surface on the robot before replacing parts on page 118</p> <p> Note</p> <p>After all repair work, wipe the Clean Room robot free from particles with spirit on a lint free cloth.</p>	

Continues on next page

5.8.1 Replacing the axis-1 gear unit sub-assembly
Continued

	Action	Note
2	<p>Refit the cable ferrule to the cable and secure it with the screw.</p> <p> Tip</p> <p>The cable ferrule should be refitted at the position where the tape is wrapped.</p> <p> Tip</p> <p>Align all the cable ferrules so that the cable is in a natural bending position to avoid twisting.</p>	<p>Screws: Hex socket head cap screw M3x8 12.9 Lafre 2C2B/FC6.9 (2 pcs)</p> <p>Tightening torque: 1.2 Nm ±10%</p>  <p>xx1800002900</p>

Refitting the base bracket

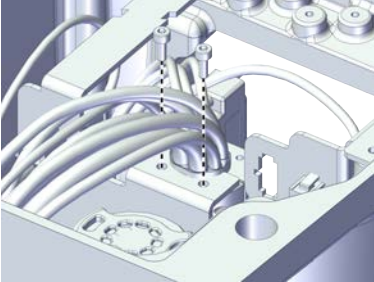
	Action	Note
1	<p> DANGER</p> <p>Make sure that all supplies for electrical power, hydraulic pressure, and air pressure are turned off.</p>	
2	<p> CAUTION</p> <p>For robots with protection type Clean Room</p> <p>Always cut the paint with a knife and grind the paint edge when disassembling parts of the robot! See Cut the paint or surface on the robot before replacing parts on page 118.</p>	
3	<p>Lay the main harness in a natural state without distortion.</p>	
	<p>Secure the cable ferrule to the bracket.</p> <p> Tip</p> <p>Align all the cable ferrules so that the cable is in a natural bending position to avoid twisting.</p> <p> Note</p> <p>The harness are not visible due to the cleanness requirements of the illustration. They are still existing inside the cable ferrule in the actual situation.</p>	<p>Screws: Hex socket head cap screw M3x8 12.9 Lafre 2C2B/FC6.9 (2 pcs)</p> <p>Tightening torque: 1.2 Nm ±10%</p>  <p>xx2100000951</p>

Continues on next page



5 Repair

5.8.1 Replacing the axis-1 gear unit sub-assembly

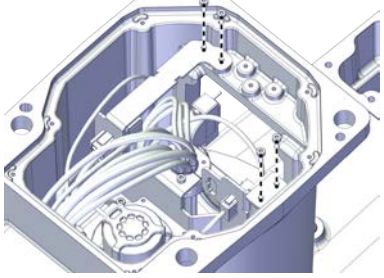
Continued

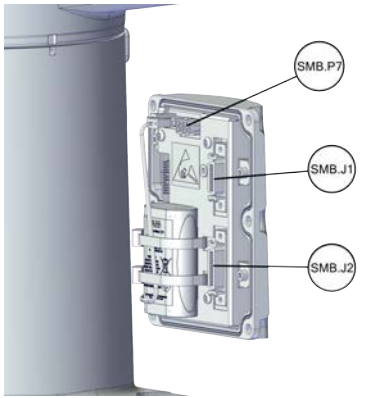

	Action	Note
4	Refit the base bracket to the base and secure with the screws.	<p>Screws: Hex socket head cap screw M3x8 12.9 Lafre 2C2B/FC6.9 (4 pcs) Tightening torque: 1.2 Nm \pm10%</p>  <p>xx2100000948</p>

Refitting the SMB cover

	Action	Note
1	<p>For robots with protection type Clean Room: Clean the joints that have been opened and wipe the parts free from particles with spirit on a lint free. See Cut the paint or surface on the robot before replacing parts on page 118</p> <p> Note</p> <p>After all repair work, wipe the Clean Room robot free from particles with spirit on a lint free cloth.</p>	
2	<p>Reconnect the connectors.</p> <ul style="list-style-type: none"> • SMB.P7 • SMB.J1 • SMB.J2 <p> Tip</p> <p>Take photos of the connector and cable position before disconnecting them, to have as a reference when reconnecting.</p>	 <p>xx2100000945</p>

Continues on next page

5.8.1 Replacing the axis-1 gear unit sub-assembly
Continued

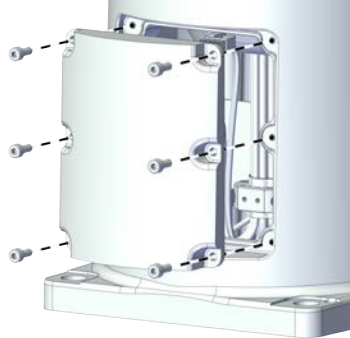
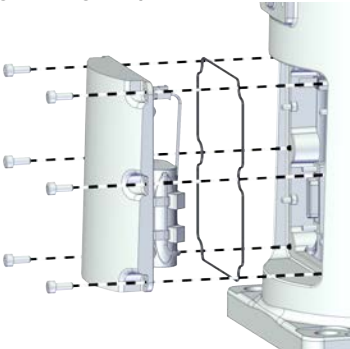
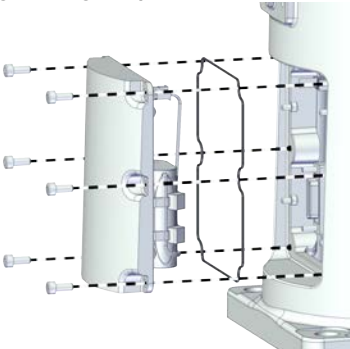
	Action	Note
3	<p>Refit the SMB cover assembly.</p> <p> Note</p> <p>For robots with protection class IP54 (option 3350-540)</p> <p>For robots with protection type Clean Room (option 3351-1)</p> <p>Check the gasket for the SMB cover.</p> <p> Tip</p> <p>Replace the gasket if needed.</p>	<p>For robots with protection class IP30 (option 3350-300)</p> <p>Screws: Hex socket head cap screw M4x10 12.9 Lafre 2C2B/FC6.9 (6 pcs)</p> <p>Tightening torque: 2.6 Nm</p> 
4	<p>Secure the SMB cover to the base with the screws.</p>	<p>xx210000944</p> <p>For robots with protection type Clean Room (option 3351-1)</p> <p>Screws: Stainless Screw Hexagon Socket Head Cap, Clean Room 3HAC075438-001 (6 pcs)</p> <p>Tightening torque: 2.6 Nm</p>  <p>xx2100002433</p> <p>For robots with protection class IP54 (option 3350-540)</p> <p>Screws: Hex socket head cap screw M4x10 12.9 Lafre 2C2B/FC6.9 (6 pcs)</p> <p>Tightening torque: 2.6 Nm</p>  <p>xx2100002433</p>

Continues on next page

5 Repair

5.8.1 Replacing the axis-1 gear unit sub-assembly

Continued

Refitting the main harness

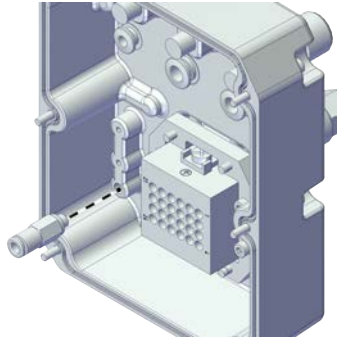
	Action	Note
1	<p>For robots with protection type Clean Room: Clean the joints that have been opened and wipe the parts free from particles with spirit on a lint free. See Cut the paint or surface on the robot before replacing parts on page 118</p> <p> Note</p> <p>After all repair work, wipe the Clean Room robot free from particles with spirit on a lint free cloth.</p>	
2	<p>For robots with protection type Clean Room (option 3351-1) Refit the one way valve by screwing it into the main harness assembly.</p>	 xx2200000281

Continues on next page

5.8.1 Replacing the axis-1 gear unit sub-assembly
Continued

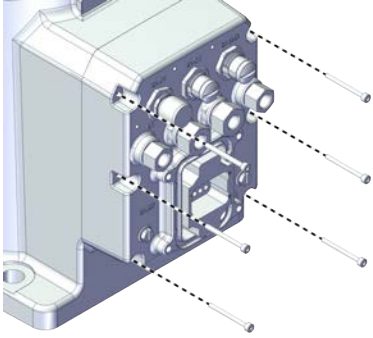
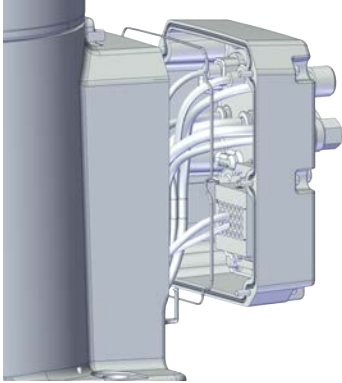
	Action	Note
3	For rear outlet cable version, refit the main harness to the base.	For rear outlet cable version:
4	Secure with the screws.	<p>For robots with protection class IP30 (option 3350-300)</p> <p>Screws: Hex socket head cap screw M3x30 12.9 Lafre 2C2B/FC6.9 (6 pcs)</p> <p>Tightening torque: 1.2 Nm ±10%</p>  <p>xx2100000953</p> <p>For robots with protection class IP54 (option 3350-540)</p> <p>For robots with protection type Clean Room (option 3351-1)</p> <p>Screws: Hex socket head cap screw M3x30 12.9 Lafre 2C2B/FC6.9 (6 pcs)</p> <p>Tightening torque: 1.2 Nm ±10%</p>  <p>xx2100002436</p>

Continues on next page

5 Repair

5.8.1 Replacing the axis-1 gear unit sub-assembly

Continued

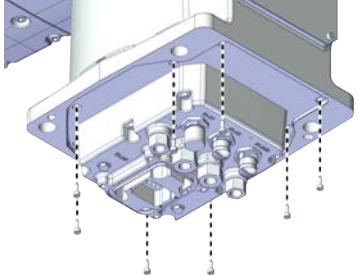
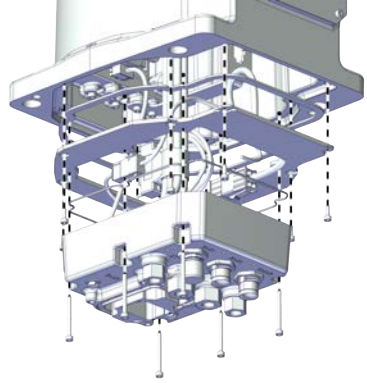
	Action	Note
5	<p>For underneath outlet cable version, refit the main harness assembly to the base.</p> <p> Note</p> <p>Refit the bottom plate to the main harness if needed.</p>	<p>For underneath outlet cable version:</p> <p>For robots with protection class IP30 (option 3350-300)</p> <p>Screws: Hex socket head cap screw M3x30 12.9 Lafre 2C2B/FC6.9 (8 pcs)</p> <p>Tightening torque: 1.2 Nm \pm10%</p>
6	Secure with the screws.	 <p>xx2100001204</p> <p>For robots with protection class IP54 (option 3350-540)</p> <p>For robots with protection type Clean Room (option 3351-1)</p> <p>Screws: Hex socket head cap screw M3x30 12.9 Lafre 2C2B/FC6.9 (8 pcs)</p> <p>Tightening torque: 1.2 Nm \pm10%</p>  <p>xx2100002437</p>

Refitting the base plate/ rear plate

	Action	Note
1	<p>For robots with protection type Clean Room:</p> <p>Clean the joints that have been opened and wipe the parts free from particles with spirit on a lint free. See Cut the paint or surface on the robot before replacing parts on page 118</p> <p> Note</p> <p>After all repair work, wipe the Clean Room robot free from particles with spirit on a lint free cloth.</p>	

Continues on next page

5.8.1 Replacing the axis-1 gear unit sub-assembly*Continued*





	Action	Note
2	Apply grease to the internal harness, cover all moving area of the harness.	

Continues on next page

5 Repair

5.8.1 Replacing the axis-1 gear unit sub-assembly

Continued

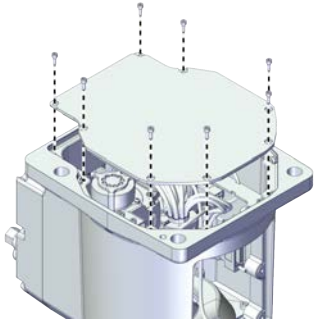
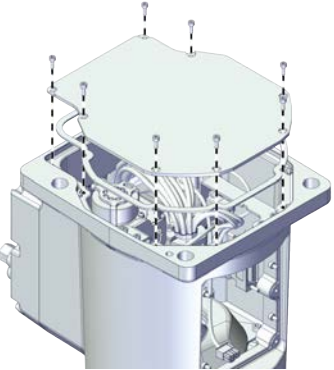
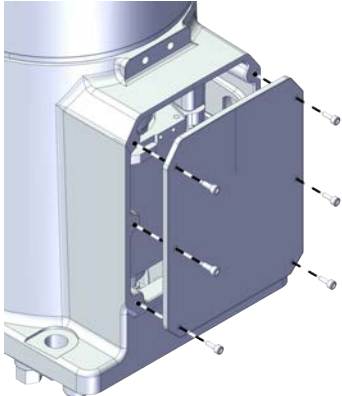
	Action	Note
3	<p>For rear outlet cable version, refit the base plate to the base.</p> <p> Note</p> <p>For robots with protection class IP54 (option 3350-540) For robots with protection type Clean Room (option 3351-1) Check the gasket for the base plate before refitting the base plate.</p> <p> Tip</p> <p>Replace the gasket if needed.</p> <p>For undeneath outlet cable version, refit the rear plate to the base.</p> <p> Note</p> <p>For robots with protection class IP54 (option 3350-540) For robots with protection type Clean Room (option 3351-1) Check the gasket for the rear plate before refitting the rear plate.</p> <p> Tip</p> <p>Replace the gasket if needed.</p>	<p>Screws: Hex socket head cap screw M3x30 12.9 Lafre 2C2B/FC6.9 (6 pcs) Tightening torque: 1.2 Nm ±10%</p> <p>For rear outlet cable version: For robots with protection class IP30 (option 3350-300)</p>  <p>xx210000946</p> <p>For robots with protection class IP54 (option 3350-540) For robots with protection type Clean Room (option 3351-1)</p>  <p>xx2100002434</p>
4	<p>Secure the base plate/ rear plate to the base with the screws.</p>	<p>For undeneath outlet cable version: For robots with protection class IP30 (option 3350-300)</p>  <p>xx2100001202</p>

Continues on next page

5.8.1 Replacing the axis-1 gear unit sub-assembly

Continued

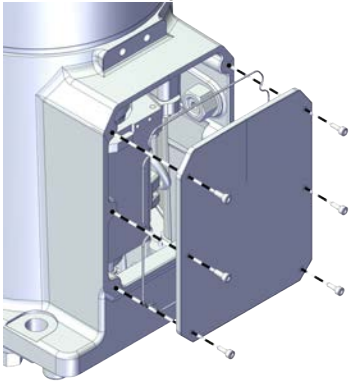
	Action	Note
		<p>For robots with protection class IP54 (option 3350-540)</p> <p>For robots with protection type Clean Room (option 3351-1)</p>  <p>xx2100002435</p>
5	Refit the robot back to the ground.	
6	Secure with the screws.	<p>Screws: Hex socket head cap screw M12x35 12.9 Gleitmo 603+Geomet 500 (4 pcs)</p> <p>Steel</p> <p>Washers: 24 mm x 13 mm x 2.5 mm (4 pcs)</p> <p>Tightening torque: 56 Nm ±10%</p>

Inserting the main harness through the axis -2 gearbox position

	Action	Note
1	<p>For robots with protection type Clean Room: Clean the joints that have been opened and wipe the parts free from particles with spirit on a lint free. See Cut the paint or surface on the robot before replacing parts on page 118</p> <p> Note</p> <p>After all repair work, wipe the Clean Room robot free from particles with spirit on a lint free cloth.</p>	

Continues on next page

5 Repair

5.8.1 Replacing the axis-1 gear unit sub-assembly

Continued

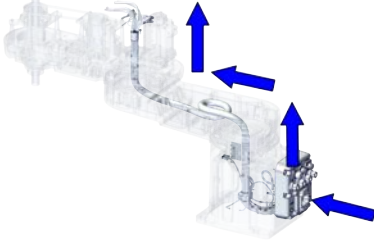
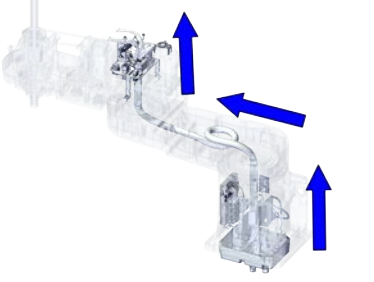





	Action	Note
2	<p>Insert the internal harness into the outer arm through the plastic protection tube and the centre of the axis-2 gearbox.</p> <p> Tip</p> <p>Wrap the connectors with the masking tape.</p>	<p>For rear outlet cable version:</p>  <p>xx2100000955</p> <p>For underneath outlet cable version:</p>  <p>xx2100001206</p>
3	Secure the R2.MP3 and R2.MP4 with cable straps.	

Refitting the cable ferrule and bracket in the outer arm

	Action	Note
1	<p>For robots with protection type Clean Room: Clean the joints that have been opened and wipe the parts free from particles with spirit on a lint free. See Cut the paint or surface on the robot before replacing parts on page 118</p> <p> Note</p> <p>After all repair work, wipe the Clean Room robot free from particles with spirit on a lint free cloth.</p>	
2	Lay the internal harness in a natural state without distortion.	

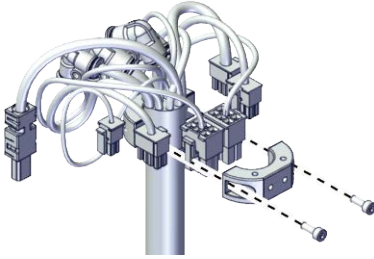
Continues on next page

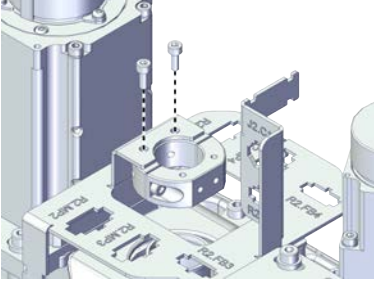
5.8.1 Replacing the axis-1 gear unit sub-assembly
Continued

	Action	Note
3	<p>Refit the cable ferrule and secure it with the screws.</p> <p> Tip</p> <p>The air hoses should face the process hub side.</p> <p> Tip</p> <p>The position with wrapped tape is the marked position for the cable ferrule.</p> <p> Tip</p> <p>Align all the cable ferrules so that the cable is in a natural bending position to avoid twisting.</p>	<p>Screws: Hex socket head cap screw M3x8 12.9 Lafre 2C2B/FC6.9 (2 pcs) Tightening torque: 1.2 Nm ±10%</p>  <p>xx1800002849</p>
4	<p>Secure the cable ferrule to the bracket.</p> <p> Tip</p> <p>Align all the cable ferrules so that the cable is in a natural bending position to avoid twisting.</p> <p> Note</p> <p>The harness are not visible due to the cleanness requirements of the illustration. They are still existing inside the cable ferrule in the actual situation.</p>	<p>Screws: Hex socket head cap screw M3x8 12.9 Lafre 2C2B/FC6.9 (2 pcs) Tightening torque: 1.2 Nm ±10%</p>  <p>xx2100000940</p>
5	<p>Refit the bracket without securing.</p> <p> Tip</p> <p>Do not secure it with the screws before the cable ferrule installed well.</p> <p> Note</p> <p>The harness are not visible due to the cleanness requirements of the illustration. They are still existing inside the cable ferrule in the actual situation.</p>	







Continues on next page

5 Repair

5.8.1 Replacing the axis-1 gear unit sub-assembly

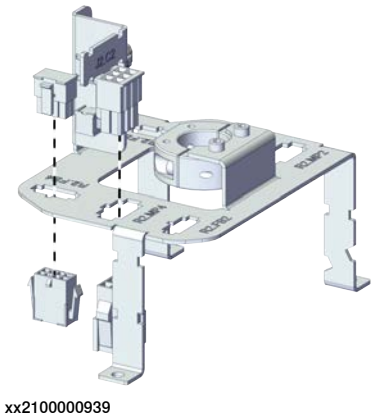

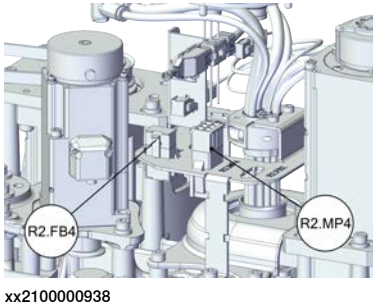



Continued

Reconnecting the connectors for axis-4 motor

	Action	Note
1	<p>For robots with protection type Clean Room: Clean the joints that have been opened and wipe the parts free from particles with spirit on a lint free. See Cut the paint or surface on the robot before replacing parts on page 118</p> <p> Note</p> <p>After all repair work, wipe the Clean Room robot free from particles with spirit on a lint free cloth.</p>	
	<p>Insert the female head of the connectors to the bracket accordingly.</p> <p> Tip</p> <p>The mistake proofing measure has been applied to the connectors, the connectors may be damaged if excessive force is used.</p> <p> Note</p> <p>The harness are not visible due to the cleanness requirements of the illustration. They are still existing inside the cable ferrule in the actual situation.</p>	 <p>xx210000939</p>
2	<p>Reconnect the connectors.</p> <ul style="list-style-type: none"> • R2.MP4 • R2.FB4 <p> Tip</p> <p>See the number markings on the connectors for help to find the corresponding connector.</p>	 <p>xx210000938</p>
3	<p>Route the cabling on the axis-4 motor.</p> <p> CAUTION</p> <p>Correct cable routing is highly important. If the cables are routed and secured incorrectly the cables can be damaged.</p>	

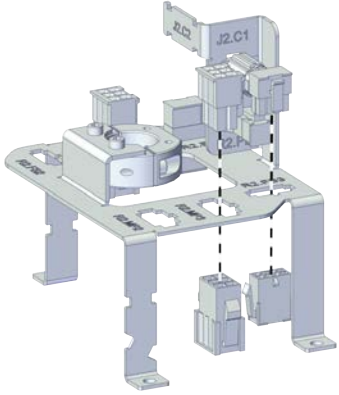
Continues on next page

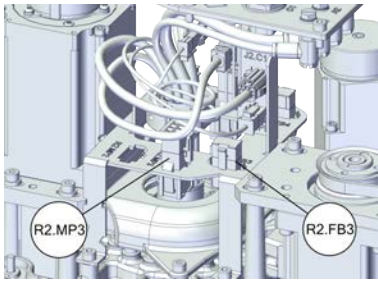
Reconnecting the connectors for axis-3 motor

	Action	Note
1	<p>For robots with protection type Clean Room: Clean the joints that have been opened and wipe the parts free from particles with spirit on a lint free. See Cut the paint or surface on the robot before replacing parts on page 118</p> <p> Note</p> <p>After all repair work, wipe the Clean Room robot free from particles with spirit on a lint free cloth.</p>	
2	<p>Insert the female head of the connectors to the bracket accordingly.</p> <p> Tip</p> <p>The mistake proofing measure has been applied to the connectors, the connectors may be damaged if excessive force is used.</p> <p> Note</p> <p>The harness are not visible due to the cleanness requirements of the illustration. They are still existing inside the cable ferrule in the actual situation.</p>	 <p>xx2100000937</p>
3	<p>Reconnect the connectors.</p> <ul style="list-style-type: none"> • R2.MP3 • R2.FB3 <p> Tip</p> <p>See the number markings on the connectors for help to find the corresponding connector.</p>	 <p>xx2100000936</p>
4	<p>Route the cabling on the axis-3 motor.</p> <p> CAUTION</p> <p>Correct cable routing is highly important. If the cables are routed and secured incorrectly the cables can be damaged.</p>	







Continues on next page

5 Repair

5.8.1 Replacing the axis-1 gear unit sub-assembly

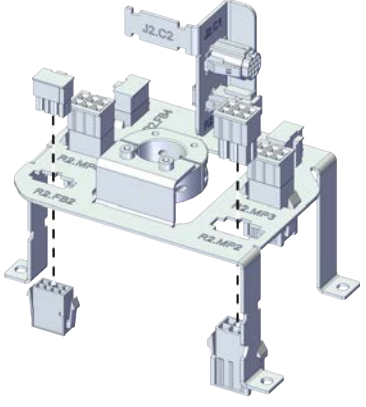

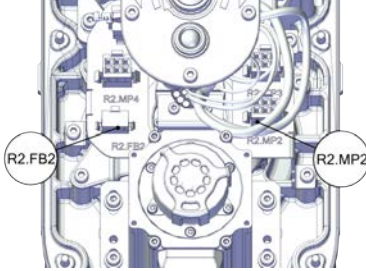



Continued

Reconnecting the connectors for axis-2 motor

	Action	Note
1	<p>For robots with protection type Clean Room: Clean the joints that have been opened and wipe the parts free from particles with spirit on a lint free. See Cut the paint or surface on the robot before replacing parts on page 118</p> <p> Note</p> <p>After all repair work, wipe the Clean Room robot free from particles with spirit on a lint free cloth.</p>	
2	<p>Insert the female head of the connectors to the bracket accordingly.</p> <p> Tip</p> <p>The mistake proofing measure has been applied to the connectors, the connectors may be damaged if excessive force is used.</p> <p> Note</p> <p>The harness are not visible due to the cleanness requirements of the illustration. They are still existing inside the cable ferrule in the actual situation.</p>	 <p>xx2100000935</p>
3	<p>Reconnect the connectors.</p> <ul style="list-style-type: none"> • R2.MP2 • R2.FB2 <p> Tip</p> <p>See the number markings on the connectors for help to find the corresponding connector.</p>	 <p>xx2100000934</p>
4	<p>Route the cabling behind the axis-2 motor.</p> <p> CAUTION</p> <p>Correct cable routing is highly important. If the cables are routed and secured incorrectly the cables can be damaged.</p>	

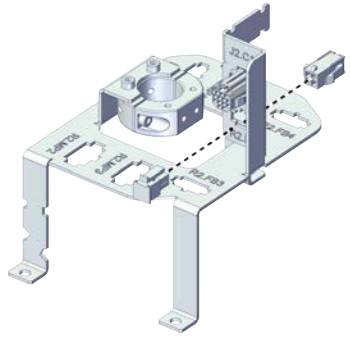
Continues on next page

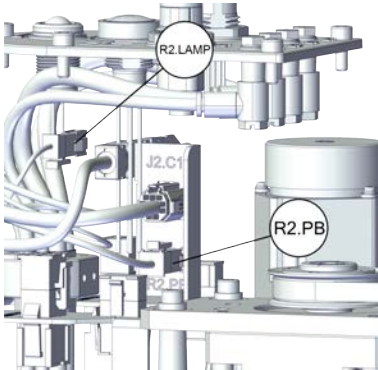
Reconnecting the connector for PB

	Action	Note
1	<p>For robots with protection type Clean Room: Clean the joints that have been opened and wipe the parts free from particles with spirit on a lint free. See Cut the paint or surface on the robot before replacing parts on page 118</p> <p> Note</p> <p>After all repair work, wipe the Clean Room robot free from particles with spirit on a lint free cloth.</p>	
2	<p>Insert the female head of the PB connector to the bracket accordingly.</p> <p> Tip</p> <p>The mistake proofing measure has been applied to the connectors, the connectors may be damaged if excessive force is used.</p> <p> Note</p> <p>The harness are not visible due to the cleanness requirements of the illustration. They are still existing inside the cable ferrule in the actual situation.</p>	 <p>xx2100001031</p>
3	<p>Reconnect the connector.</p> <ul style="list-style-type: none"> • R2.PB • R2.LAMP <p> Tip</p> <p>See the number markings on the connectors for help to find the corresponding connector.</p>	 <p>xx2100001030</p>
4	<p>Route and secure the cabling with cable straps if needed.</p> <p> CAUTION</p> <p>Correct cable routing is highly important. If the cables are routed incorrectly the cables can be damaged.</p>	



Continues on next page

5 Repair

5.8.1 Replacing the axis-1 gear unit sub-assembly







Continued

Reconnecting the air hoses, CP/CS cabling and Ethernet cabling (if equipped)

	Action	Note
1	<p>For robots with protection type Clean Room: Clean the joints that have been opened and wipe the parts free from particles with spirit on a lint free. See Cut the paint or surface on the robot before replacing parts on page 118</p> <p> Note</p> <p>After all repair work, wipe the Clean Room robot free from particles with spirit on a lint free cloth.</p>	
2	<p>Route the air hoses on the process hub behind the bracket.</p> <p> CAUTION</p> <p>Correct cable routing is highly important. If the cables are routed and secured incorrectly the cables can be damaged.</p>	

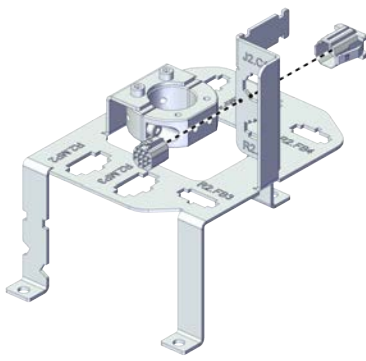
Continues on next page

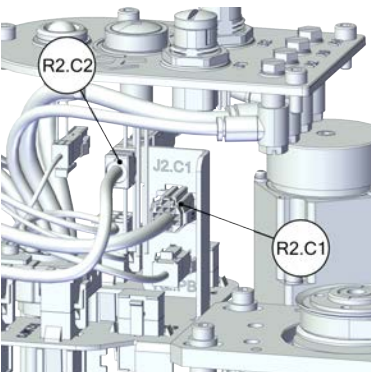
5.8.1 Replacing the axis-1 gear unit sub-assembly
Continued

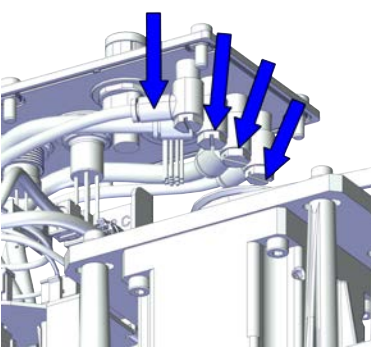
	Action	Note
3	<p>Insert the female head of the C1 cabling connector to the bracket accordingly.</p> <p> Tip</p> <p>The mistake proofing measure has been applied to the connectors, the connectors may be damaged if excessive force is used.</p> <p> Note</p> <p>The harness are not visible due to the cleanness requirements of the illustration. They are still existing inside the cable ferrule in the actual situation.</p>	 <p>xx2100001034</p>
4	<p>For robots with C1 cabling</p> <p>Reconnect the connector.</p> <ul style="list-style-type: none"> • R2.C1 <p> Tip</p> <p>See the number markings on the air hoses for help to find the corresponding air hoses.</p> <p>The air hoses with the same number connect to the same L-shaped connector.</p>	 <p>xx2100001033</p>
5	<p>For robots with C2 cabling</p> <p>Reconnect the connector.</p> <ul style="list-style-type: none"> • R1.C2 <p> Tip</p> <p>See the number markings on the air hoses for help to find the corresponding air hoses.</p> <p>The air hoses with the same number connect to the same L-shaped connector.</p>	
6	<p>Secure the C2 cabling to the C2 bracket with the cable straps.</p>	
7	<p>Reconnect the air hoses in a cross pattern with the L-shaped connectors.</p> <p> Tip</p> <p>See the number markings on the air hoses for help to find the corresponding air hoses.</p> <p>The air hoses with the same number connect to the same Y-shaped connector.</p>	 <p>xx2100001032</p>

Continues on next page



5 Repair

5.8.1 Replacing the axis-1 gear unit sub-assembly

Continued

	Action	Note
8	<p>Route and secure the cabling with cable straps if needed.</p> <p> CAUTION</p> <p>Correct cable routing is highly important. If the cables are routed and secured incorrectly the cables can be damaged.</p>	

Securing the bracket in the outer arm

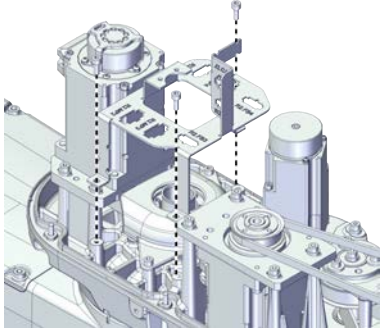

	Action	Note
1	<p>For robots with protection type Clean Room: Clean the joints that have been opened and wipe the parts free from particles with spirit on a lint free. See Cut the paint or surface on the robot before replacing parts on page 118</p> <p> Note</p> <p>After all repair work, wipe the Clean Room robot free from particles with spirit on a lint free cloth.</p>	
2	<p>Refit the bracket.</p> <p> Tip</p> <p>Do not secure it with the screws before the cable ferrule installed well.</p> <p> Note</p> <p>The harness are not visible due to the cleanness requirements of the illustration. They are still existing inside the cable ferrule in the actual situation.</p>	<p>Screws: Hex socket head cap screw M4x10 12.9 Lafre 2C2B/FC6.9 (3 pcs) Tightening torque: 1.2 Nm \pm10%</p>  <p>xx2100000941</p>

Refitting the cover of the outer arm

	Action	Note
1	<p>For robots with protection type Clean Room: Clean the joints that have been opened and wipe the parts free from particles with spirit on a lint free. See Cut the paint or surface on the robot before replacing parts on page 118</p> <p> Note</p> <p>After all repair work, wipe the Clean Room robot free from particles with spirit on a lint free cloth.</p>	

Continues on next page

5.8.1 Replacing the axis-1 gear unit sub-assembly
Continued

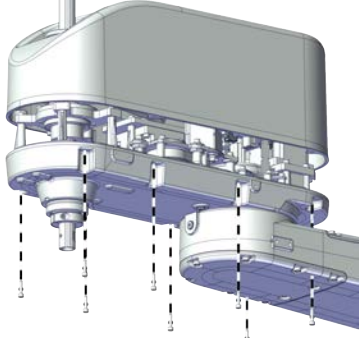
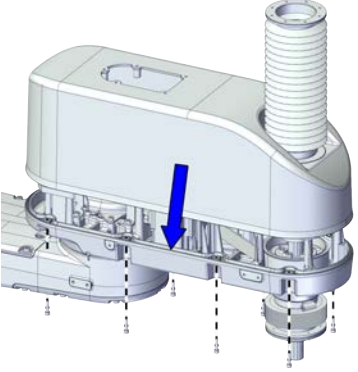
	Action	Note
2	<p>Refit the cover.</p> <p> Note</p> <p>For robots with protection class IP54 (option 3350-540)</p> <p>For robots with protection type Clean Room (option 3351-1)</p> <p>Refit the cover with bellow.</p> <p>Check the gasket for the outer arm cover.</p> <p> Tip</p> <p>Replace the gasket if needed.</p> <p> CAUTION</p> <p>The gasket is in the outer arm.</p>	<p>Screw: Hex socket head cap screw M4x16 12.9 Lafre 2C2B/FC6.9 (8 pcs)</p> <p>Tightening torque: 2 Nm ±10%</p> <p>For robots with protection class IP30 (option 3350-300)</p>  <p>xx210000933</p>
3	<p>Refit the screws.</p>	<p>For robots with protection class IP54 (option 3350-540)</p> <p>For robots with protection type Clean Room (option 3351-1)</p>  <p>xx2100002427</p>

For Clean Room/ IP54 robots

Refitting the top cover and the flange with bearing



	Action	Note
1	<p>For robots with protection type Clean Room:</p> <p>Clean the joints that have been opened and wipe the parts free from particles with spirit on a lint free. See Cut the paint or surface on the robot before replacing parts on page 118</p> <p> Note</p> <p>After all repair work, wipe the Clean Room robot free from particles with spirit on a lint free cloth.</p>	

Continues on next page

5 Repair

5.8.1 Replacing the axis-1 gear unit sub-assembly

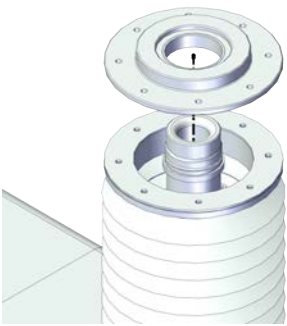
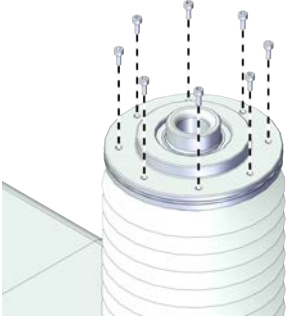
Continued

	Action	Note
2	<p>For robots with protection class IP54 (option 3350-540) For robots with protection type Clean Room (option 3351-1) Install the flange with bearing to the extension shaft.</p>	 <p>xx2100002402</p>
3	<p>For robots with protection class IP54 (option 3350-540) For robots with protection type Clean Room (option 3351-1) Refit the screws to the flange with bearing.</p>	<p>Screws: Hex socket head cap screw M2.5x6 12.9 Lafre 2C2B/FC6.9 (8 pcs) Tightening torque: 0.8 Nm \pm10%</p>  <p>xx2100002401</p>
4	<p>For robots with protection class IP54 (option 3350-540) For robots with protection type Clean Room (option 3351-1) Refit the top cover to the ball screw.</p> <p> Tip</p> <p>The top surface of the cover should be flush with the top end of the ball screw.</p>	 <p>xx2100002399</p>

Continues on next page

5.8.1 Replacing the axis-1 gear unit sub-assembly

Continued

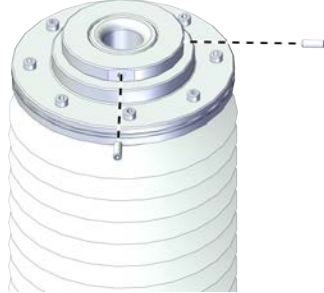
	Action	Note
5	<p>For robots with protection class IP54 (option 3350-540)</p> <p>For robots with protection type Clean Room (option 3351-1)</p> <p>Refit the locking screws.</p>	<p>Screws: Hexagon socket set screws with flat point, ISO 4026 stainless steel M3x8 (2 pcs)</p> <p>Tightening torque: 0.4 Nm \pm10%</p>  <p>xx2100002398</p>

Securing the process hub to outer arm cover



	Action	Note
1	<p>For robots with protection type Clean Room:</p> <p>Clean the joints that have been opened and wipe the parts free from particles with spirit on a lint free. See Cut the paint or surface on the robot before replacing parts on page 118</p> <p> Note</p> <p>After all repair work, wipe the Clean Room robot free from particles with spirit on a lint free cloth.</p>	
2	Insert the process hub from the outer arm cover.	

Continues on next page

5 Repair

5.8.1 Replacing the axis-1 gear unit sub-assembly

Continued

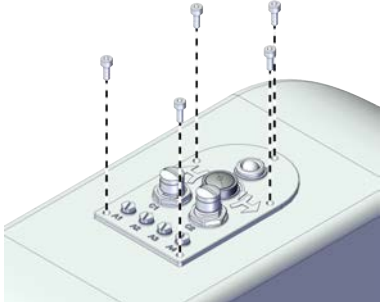
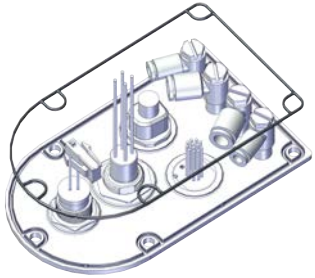

	Action	Note
3	<p>Secure the process hub to the outer arm cover with the screws.</p> <p> Note</p> <p>For robots with protection class IP54 (option 3350-540) For robots with protection type Clean Room (option 3351-1) Check the gasket for the process hub.</p> <p> Tip</p> <p>Replace the gasket if needed.</p> <p> CAUTION</p> <p>Be aware of the cabling that is attached to the cover! The cover can not be removed completely until the connectors are disconnected, as shown in following steps.</p>	<p>Screws: Hex socket head cap screw M4x10 12.9 Lafre 2C2B/FC6.9 (5 pcs) Tightening torque: 2.6 Nm±10% For robots with protection class IP30 (option 3350-300)</p>  <p>xx2100000932</p> <p>For robots with protection class IP54 (option 3350-540) For robots with protection type Clean Room (option 3351-1)</p>  <p>xx2100002438</p>

Refitting the axis-1 cover

	Action	Note
1	<p>For robots with protection type Clean Room: Clean the joints that have been opened and wipe the parts free from particles with spirit on a lint free. See Cut the paint or surface on the robot before replacing parts on page 118</p> <p> Note</p> <p>After all repair work, wipe the Clean Room robot free from particles with spirit on a lint free cloth.</p>	

Continues on next page

5.8.1 Replacing the axis-1 gear unit sub-assembly
Continued

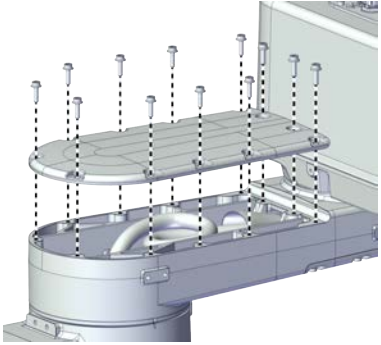
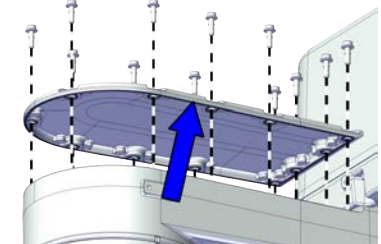
	Action	Note
2	<p>Refit the cover.</p> <p> Note</p> <p>For robots with protection class IP54 (option 3350-540)</p> <p>For robots with protection type Clean Room (option 3351-1)</p> <p>Check the gasket for the cover before refitting the cover.</p> <p> Tip</p> <p>Replace the gasket if needed.</p>	<p>For IRB 920T-6/0.45 : Screw: Hex socket head cap flange screw M5x16 12.9 Lafre 2C2B/FC6.9+PrO-COat111 (10 pcs)</p> <p>For IRB 920T-6/0.55 : Screw: Hex socket head cap flange screw M5x16 12.9 Lafre 2C2B/FC6.9+PrO-COat111 (12 pcs)</p> <p>For IRB 920T-6/0.65 : Screw: Hex socket head cap flange screw M5x16 12.9 Lafre 2C2B/FC6.9+PrO-COat111 (16 pcs)</p> <p>Tightening torque: 5.4 Nm ±3%</p> <p>For robots with protection class IP30 (option 3350-300)</p>
3	<p>Refit the screws.</p>	 <p>xx2100000942</p> <p>For robots with protection class IP54 (option 3350-540)</p> <p>For robots with protection type Clean Room (option 3351-1)</p>  <p>xx2100002428</p>

Refitting the axis-2 cover



	Action	Note
1	<p> DANGER</p> <p>Make sure that all supplies for electrical power, hydraulic pressure, and air pressure are turned off.</p>	

Continues on next page

5 Repair

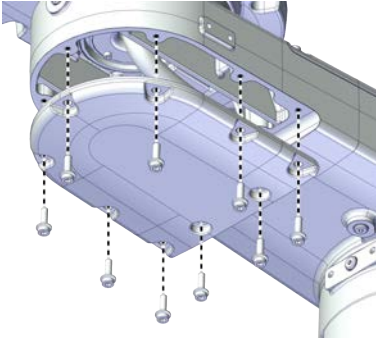
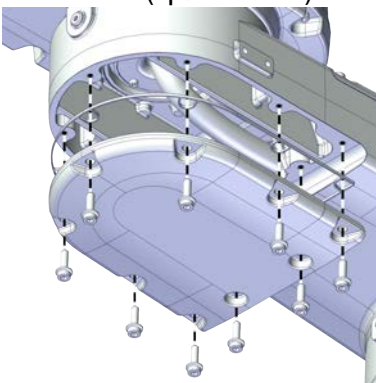

5.8.1 Replacing the axis-1 gear unit sub-assembly

Continued

	Action	Note
2	<p> CAUTION</p> <p>For robots with protection type Clean Room Always cut the paint with a knife and grind the paint edge when disassembling parts of the robot! See <i>Cut the paint or surface on the robot before replacing parts on page 118.</i></p>	
3	<p>Refit the cover.</p> <p> Note</p> <p>For robots with protection class IP54 (option 3350-540) For robots with protection type Clean Room (option 3351-1) Check the gasket for the cover before refitting the cover.</p> <p> Tip</p> <p>Replace the gasket if needed.</p>	<p>Screws: Hex socket head cap flange screw M5x16 12.9 Lafre 2C2B/FC6.9+PrO-COat111 (9 pcs) Tightening torque: 1.2 Nm ±10%</p> <p>For robots with protection class IP30 (option 3350-300)</p>  <p>xx210000943</p>
4	<p>Refit the screws.</p>	<p>For robots with protection class IP54 (option 3350-540) For robots with protection type Clean Room (option 3351-1)</p>  <p>xx2100002451</p>

Continues on next page

Concluding procedure

	Action	Note
1	<p>For robots with protection type Clean Room: Seal and paint the joints that have been opened. See Cut the paint or surface on the robot before replacing parts on page 118</p> <p> Note</p> <p>After all repair work, wipe the Clean Room robot free from particles with spirit on a lint free cloth.</p>	
2	Recalibrate the robot.	Calibration is detailed in section Calibration on page 945 .
3	<p> DANGER</p> <p>Make sure all safety requirements are met when performing the first test run.</p>	

5 Repair

5.8.2 Replacing the axis-2 gear unit sub-assembly

5.8.2 Replacing the axis-2 gear unit sub-assembly

Location of the axis-2 gear unit sub-assembly

The axis-2 gear unit sub-assembly is located as shown in the figure.

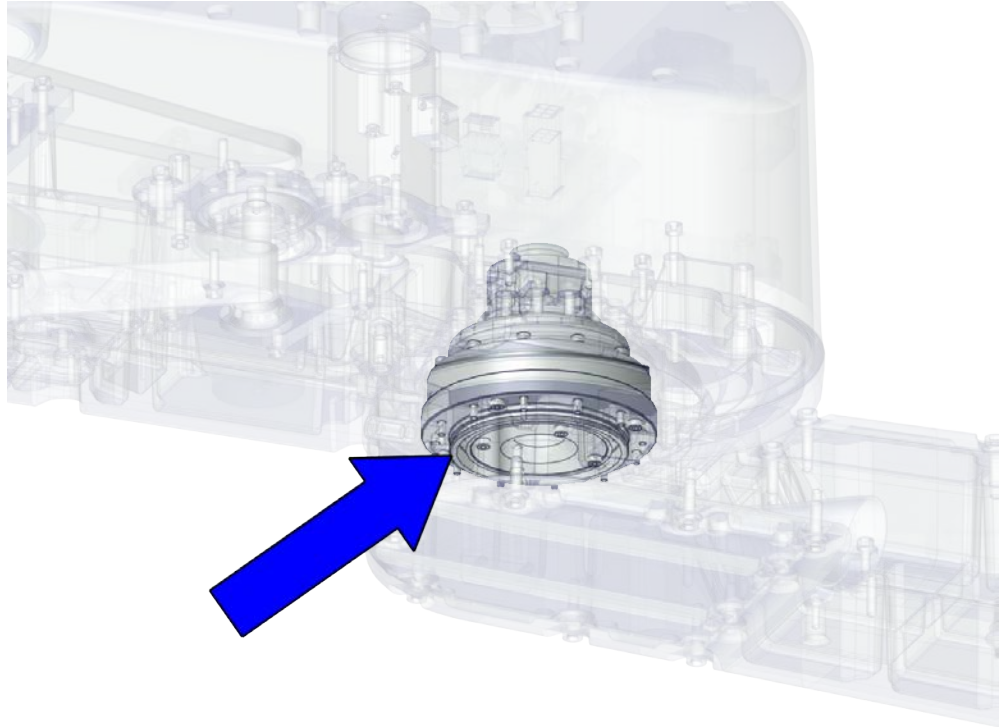

xx2100001028

Required spare parts



Note

The spare part numbers that are listed in the table can be out of date. See the latest spare parts of the IRB 920 via myABB Business Portal, www.abb.com/myABB.

Spare part	Article number	Note
Axis-2 gear unit sub-assembly	3HAC076574-001	
Pulley protection cover	3HAC070461-001	Replace if damaged.
O-ring	3HAC061327-017	Replace if damaged.

Required tools and equipment

Equipment	Article number	Note
Standard toolkit	-	Content is defined in section Standard toolkit on page 996 .

Continues on next page

Equipment	Article number	Note
Calibration toolbox, Axis Calibration	3HAC055412-001	Delivered as a set of calibration tools. Required if Axis Calibration is the valid calibration method for the robot.
Sonic tension meter	-	Used for measuring the timing belt tension.
Handheld dynamometer	-	Used for measuring the timing belt tension.

Required consumables

Consumable	Article number	Note
Cable straps	-	
Grease	3HAC029132-001	FM 222

Deciding calibration routine

Decide which calibration routine to be used, based on the information in the table. Depending on which routine is chosen, action might be required prior to beginning the repair work of the robot, see the table.

	Action	Note
1	<p>Decide which calibration routine to use for calibrating the robot.</p> <ul style="list-style-type: none"> Reference calibration. External cable packages (DressPack) and tools can stay fitted on the robot. Fine calibration. All external cable packages (DressPack) and tools must be removed from the robot. 	
	<p>If the robot is to be calibrated with reference calibration:</p> <p>Find previous reference values for the axis or create new reference values. These values are to be used after the repair procedure is completed, for calibration of the robot.</p> <p>If no previous reference values exist, and no new reference values can be created, then reference calibration is not possible.</p>	<p>Follow the instructions given in the reference calibration routine on the FlexPendant to create reference values.</p> <p>Creating new values requires possibility to move the robot.</p> <p>Read more about reference calibration for Axis Calibration in Reference calibration routine on page 957.</p>
	<p>If the robot is to be calibrated with fine calibration:</p> <p>Remove all external cable packages (DressPack) and tools from the robot.</p>	

Continues on next page

5 Repair



5.8.2 Replacing the axis-2 gear unit sub-assembly

Continued

Removing the axis-2 gear unit sub-assembly



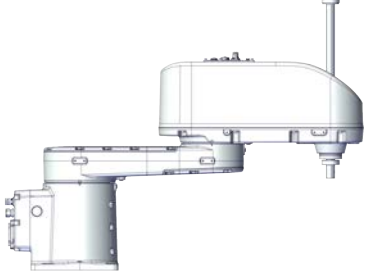

Use these procedures to remove the axis-2 gear unit sub-assembly.

Preparations before removing the axis-2 gear unit sub-assembly

	Action	Note
1	Decide which calibration routine to use, and take actions accordingly prior to beginning the repair procedure.	
2	<p>If there is no enough space for the maintenance work, remove the robot from the wall and place it on the maintenance bracket.</p> <p> CAUTION</p> <p>Do not lay down the robot during the transportation, always keep it straight. If the robot lay down in any situation, the grease may come out from gearbox.</p>	
3	Jog all axes to zero position.	 xx2100000930
4	<p> DANGER</p> <p>Turn off all:</p> <ul style="list-style-type: none">• electric power supply• hydraulic pressure supply• air pressure supply <p>to the robot, before entering the safeguarded space.</p>	
5	<p> CAUTION</p> <p>For robots with protection type Clean Room Always cut the paint with a knife and grind the paint edge when disassembling parts of the robot! See <i>Cut the paint or surface on the robot before replacing parts on page 118.</i></p>	

Continues on next page

Removing the process hub screws

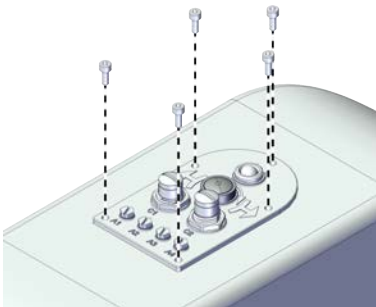
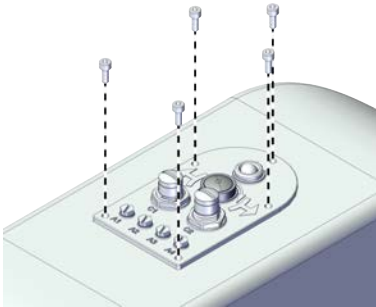
	Action	Note
1	 DANGER Make sure that all supplies for electrical power, hydraulic pressure, and air pressure are turned off.	
2	 CAUTION For robots with protection type Clean Room Always cut the paint with a knife and grind the paint edge when disassembling parts of the robot! See Cut the paint or surface on the robot before replacing parts on page 118 .	
3	Remove the screws on the process hub.  Note For robots with protection class IP54 (option 3350-540) For robots with protection type Clean Room (option 3351-1) Remove the screws on the process hub and take out the gasket.  Tip Check the gasket and replace it if needed.	For robots with protection class IP30  xx2100000932 For robots with protection class IP54 (option 3350-540) For robots with protection type Clean Room (option 3351-1)  xx2100000932
4	Insert the process hub to the outer arm.	

Continues on next page





5 Repair

5.8.2 Replacing the axis-2 gear unit sub-assembly

Continued

For Clean Room/ IP54 robots

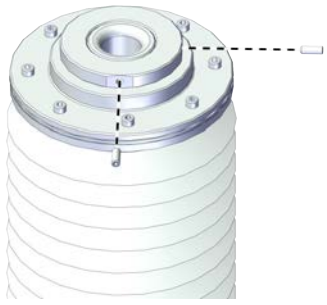
Removing the top cover and the flange with bearing



	Action	Note
1	 DANGER Make sure that all supplies for electrical power, hydraulic pressure, and air pressure are turned off.	
2	 CAUTION For robots with protection type Clean Room Always cut the paint with a knife and grind the paint edge when disassembling parts of the robot! See Cut the paint or surface on the robot before replacing parts on page 118 .	
3	For robots with protection class IP54 (option 3350-540) For robots with protection type Clean Room (option 3351-1) Loose the locking screws.	 xx2100002398
4	For robots with protection class IP54 (option 3350-540) For robots with protection type Clean Room (option 3351-1) Remove the top cover from the ball screw.	 xx2100002399

Continues on next page

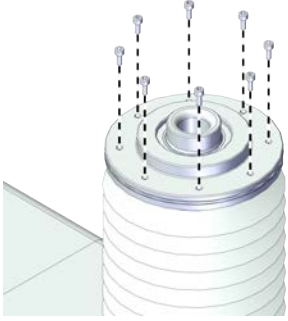
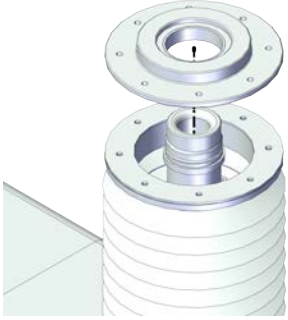
5.8.2 Replacing the axis-2 gear unit sub-assembly
Continued

	Action	Note
5	<p>For robots with protection class IP54 (option 3350-540) For robots with protection type Clean Room (option 3351-1) Remove the screws on the flange with bearing.</p>	 <p>xx2100002401</p>
6	<p>For robots with protection class IP54 (option 3350-540) For robots with protection type Clean Room (option 3351-1) Remove the flange with bearing.</p>	 <p>xx2100002402</p>

Removing the cover of the outer arm



	Action	Note
1	<p> DANGER Make sure that all supplies for electrical power, hydraulic pressure, and air pressure are turned off.</p>	
2	<p> CAUTION For robots with protection type Clean Room Always cut the paint with a knife and grind the paint edge when disassembling parts of the robot! See Cut the paint or surface on the robot before replacing parts on page 118.</p>	

Continues on next page



5 Repair

5.8.2 Replacing the axis-2 gear unit sub-assembly

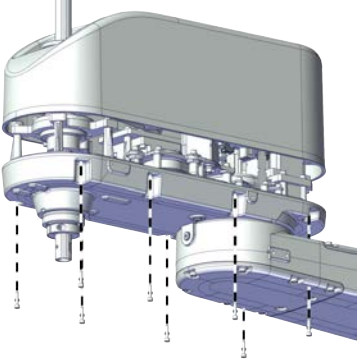
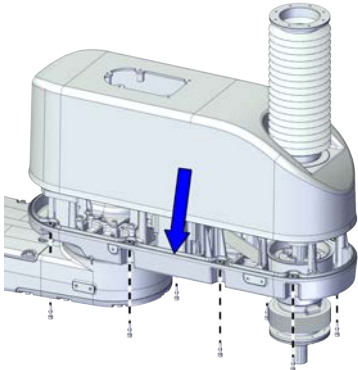
Continued





	Action	Note
3	<p>Remove the screws on the cover of the outer arm and remove the cover.</p> <p> Note</p> <p>For robots with protection class IP54 (option 3350-540) For robots with protection type Clean Room (option 3351-1) Remove the cover with bellow and housing.</p> <p> Note</p> <p>The bellow does not need to be removed separately.</p> <p> Tip</p> <p>Check the gasket and replace it if needed.</p>	<p>For robots with protection class IP30</p>  <p>xx210000933</p> <p>For robots with protection class IP54 (option 3350-540) For robots with protection type Clean Room (option 3351-1)</p>  <p>xx2100002427</p>

Disconnecting the air hoses, C1 cabling and C2 cabling (if equipped)

	Action	Note
1	<p> DANGER</p> <p>Make sure that all supplies for electrical power, hydraulic pressure, and air pressure are turned off.</p>	
2	<p> CAUTION</p> <p>For robots with protection type Clean Room Always cut the paint with a knife and grind the paint edge when disassembling parts of the robot! See Cut the paint or surface on the robot before replacing parts on page 118.</p>	

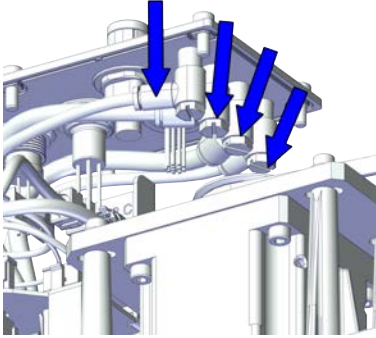
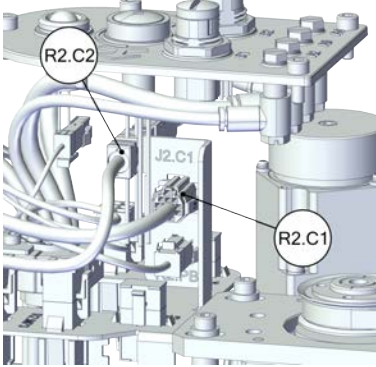
Continues on next page

5.8.2 Replacing the axis-2 gear unit sub-assembly
Continued

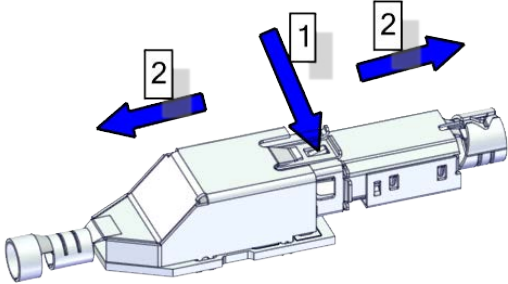
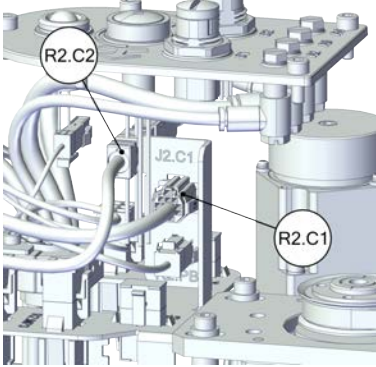
	Action	Note
3	<p>Disconnect the air hoses from the L-shaped connectors.</p>	 <p>xx2100001032</p>
4	<p>For robots with C1 cabling Disconnect the connector. • R2.C1</p>	 <p>xx2100001033</p>
5	<p>For robots with C2 cabling Disconnect the connector. • R1.C2</p> <p> Tip Cut the cable straps for the R1.C2 at the same time.</p> <p> Tip Take photos of the connector and cable position before disconnecting them, to have as a reference when reconnecting.</p> <p> Tip The connector clip has to be pressed (1) and pushed forward (2) to separate the R1.C2 (for C2 cabling).</p>  <p>xx1800002943</p>	 <p>xx2100001033</p>

Continues on next page



5 Repair

5.8.2 Replacing the axis-2 gear unit sub-assembly

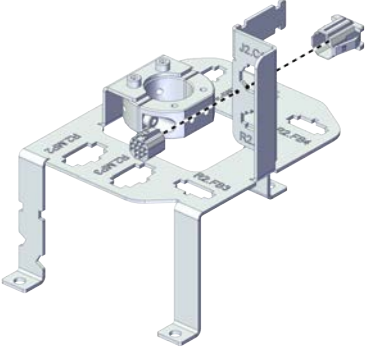
Continued

	Action	Note
6	<p>Snap loose and remove the female head of the connectors from the bracket.</p> <p> Note</p> <p>The harness are not visible due to the cleanliness requirements of the illustration. They are still existing inside the cable ferrule in the actual situation.</p>	 <p>xx2100001034</p>

Disconnecting the connectors for axis-2 motor

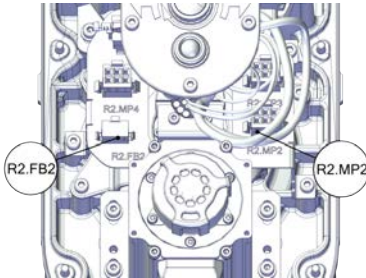

	Action	Note
1	<p> DANGER</p> <p>Make sure that all supplies for electrical power, hydraulic pressure, and air pressure are turned off.</p>	
2	<p> CAUTION</p> <p>For robots with protection type Clean Room Always cut the paint with a knife and grind the paint edge when disassembling parts of the robot! See Cut the paint or surface on the robot before replacing parts on page 118.</p>	
3	<p>Disconnect the connectors.</p> <ul style="list-style-type: none"> • R2.MP2 • R2.FB2 	 <p>xx2100000934</p>

Continues on next page

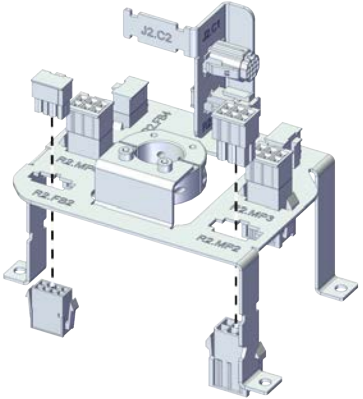
5.8.2 Replacing the axis-2 gear unit sub-assembly
Continued

	Action	Note
4	<p>Snap loose and remove the female head of the connectors from the bracket.</p> <p> Note</p> <p>The harness are not visible due to the cleanness requirements of the illustration. They are still existing inside the cable ferrule in the actual situation.</p>	 <p>xx2100000935</p>

Disconnecting the connectors for axis-3 motor

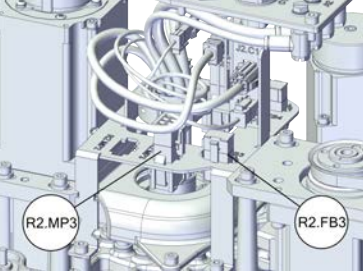
	Action	Note
1	<p> DANGER</p> <p>Make sure that all supplies for electrical power, hydraulic pressure, and air pressure are turned off.</p>	
2	<p> CAUTION</p> <p>For robots with protection type Clean Room Always cut the paint with a knife and grind the paint edge when disassembling parts of the robot! See Cut the paint or surface on the robot before replacing parts on page 118.</p>	
3	<p>Disconnect the connectors.</p> <ul style="list-style-type: none"> • R2.MP3 • R2.FB3 	 <p>xx2100000936</p>

Continues on next page



5 Repair

5.8.2 Replacing the axis-2 gear unit sub-assembly

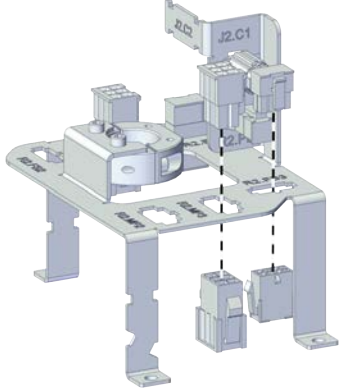
Continued



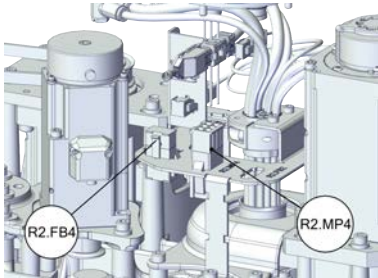

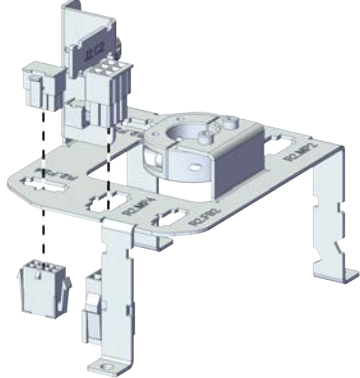
	Action	Note
4	<p>Snap loose and remove the female head of the connectors from the bracket.</p> <p> Note</p> <p>The harness are not visible due to the cleanness requirements of the illustration. They are still existing inside the cable ferrule in the actual situation.</p>	 <p>xx210000937</p>

Disconnecting the connectors for axis-4 motor

	Action	Note
1	<p>For robots with protection type Clean Room: Clean the joints that have been opened and wipe the parts free from particles with spirit on a lint free. See Cut the paint or surface on the robot before replacing parts on page 118</p> <p> Note</p> <p>After all repair work, wipe the Clean Room robot free from particles with spirit on a lint free cloth.</p>	
2	<p>Disconnect the axis-4 motor connectors.</p> <ul style="list-style-type: none"> • R2.MP4 • R2.FB4 	 <p>xx210000938</p>
3	<p>Snap loose and remove the female head of the connectors from the bracket.</p> <p> Note</p> <p>The harness are not visible due to the cleanness requirements of the illustration. They are still existing inside the cable ferrule in the actual situation.</p>	 <p>xx210000939</p>

Continues on next page

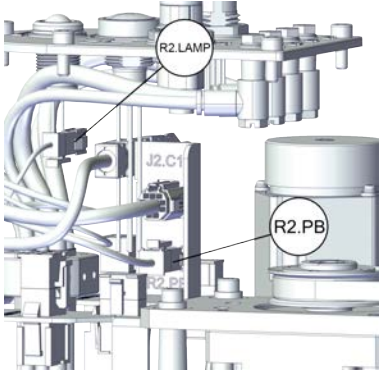
Disconnecting the connector for PB

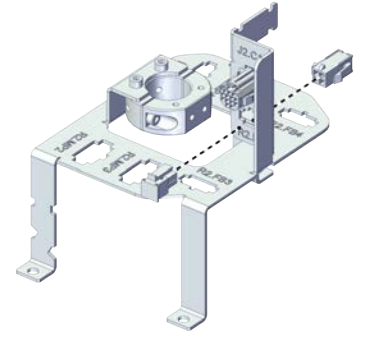
	Action	Note
1	 DANGER Make sure that all supplies for electrical power, hydraulic pressure, and air pressure are turned off.	
2	 CAUTION For robots with protection type Clean Room Always cut the paint with a knife and grind the paint edge when disassembling parts of the robot! See Cut the paint or surface on the robot before replacing parts on page 118 .	
3	Disconnect the connector. <ul style="list-style-type: none"> • R2.PB • R2.LAMP 	 <p>xx2100001030</p>
4	Snap loose and remove the female head of the connector from the bracket.  Note The harness are not visible due to the cleanliness requirements of the illustration. They are still existing inside the cable ferrule in the actual situation.	 <p>xx2100001031</p>

Pull out the process hub





	Action	Note
1	 DANGER Make sure that all supplies for electrical power, hydraulic pressure, and air pressure are turned off.	

Continues on next page



5 Repair

5.8.2 Replacing the axis-2 gear unit sub-assembly

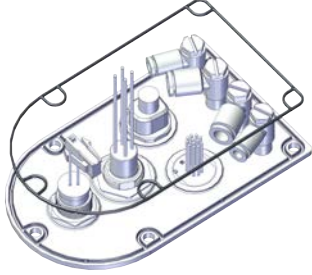
Continued



	Action	Note
2	 CAUTION For robots with protection type Clean Room Always cut the paint with a knife and grind the paint edge when disassembling parts of the robot! See Cut the paint or surface on the robot before replacing parts on page 118 .	
3	Take out the process hub.  Note For robots with protection class IP54 (option 3350-540) For robots with protection type Clean Room (option 3351-1) Check the gasket for the process hub.  Tip Replace the gasket if needed.  CAUTION Be aware of the cabling that is attached to the cover! The cover can not be removed completely until the connectors are disconnected, as shown in following steps.	For robots with protection class IP54 (option 3350-540) For robots with protection type Clean Room (option 3351-1)  xx2100002438

Removing the cable ferrule and bracket

	Action	Note
1	 DANGER Make sure that all supplies for electrical power, hydraulic pressure, and air pressure are turned off.	
2	 CAUTION For robots with protection type Clean Room Always cut the paint with a knife and grind the paint edge when disassembling parts of the robot! See Cut the paint or surface on the robot before replacing parts on page 118 .	

Continues on next page

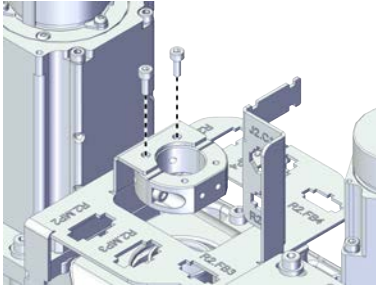
5.8.2 Replacing the axis-2 gear unit sub-assembly
Continued

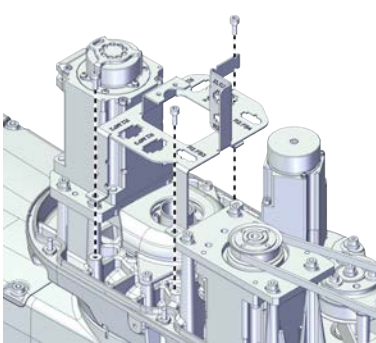
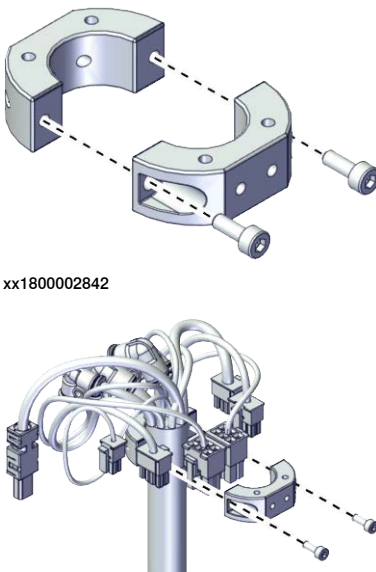
	Action	Note
3	<p>Remove the screws on the bracket to the cable ferrule to release the cable ferrule with cable.</p> <p> Note</p> <p>The harness are not visible due to the cleanness requirements of the illustration. They are still existing inside the cable ferrule in the actual situation.</p>	 <p>xx2100000940</p>
4	<p>Remove the screws on the bracket.</p> <p> Note</p> <p>The harness are not visible due to the cleanness requirements of the illustration. They are still existing inside the cable ferrule in the actual situation.</p>	 <p>xx2100000941</p>
5	<p>Remove the screws on the cable ferrule and take the cable ferrule out.</p>	 <p>xx1800002842</p> <p>xx1800002849</p>

Removing the gear-2 pulley protection cover

	Action	Note
1	<p> DANGER</p> <p>Make sure that all supplies for electrical power, hydraulic pressure, and air pressure are turned off.</p>	

Continues on next page



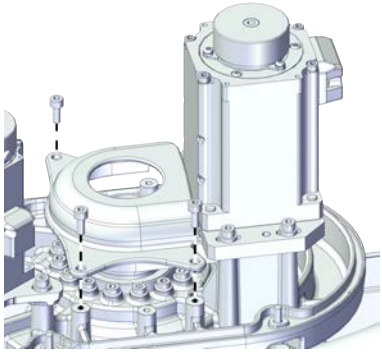

5 Repair

5.8.2 Replacing the axis-2 gear unit sub-assembly

Continued

	Action	Note
2	 CAUTION For robots with protection type Clean Room Always cut the paint with a knife and grind the paint edge when disassembling parts of the robot! See Cut the paint or surface on the robot before replacing parts on page 118 .	
3	Remove the screws on the pulley protection cover to release the pulley protection cover.	 xx2100001047

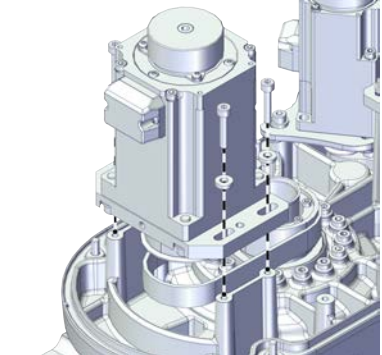

Removing the axis-2 motor sub-assembly

	Action	Note
1	 DANGER Make sure that all supplies for electrical power, hydraulic pressure, and air pressure are turned off.	
2	 CAUTION For robots with protection type Clean Room Always cut the paint with a knife and grind the paint edge when disassembling parts of the robot! See Cut the paint or surface on the robot before replacing parts on page 118 .	
3	Remove the screws and washers.	 xx2100001046
4	Remove the motor.  Tip Move the internal harness out of the way.	



Continues on next page

5.8.2 Replacing the axis-2 gear unit sub-assembly
Continued

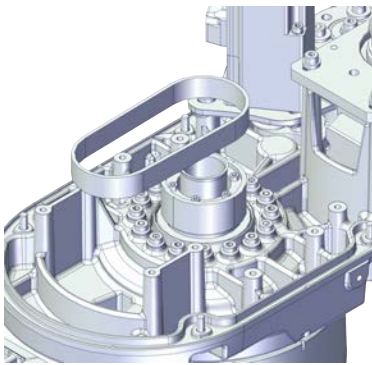
Removing the axis-2 timing belt

	Action	Note
1	 DANGER Make sure that all supplies for electrical power, hydraulic pressure, and air pressure are turned off.	
2	 CAUTION For robots with protection type Clean Room Always cut the paint with a knife and grind the paint edge when disassembling parts of the robot! See Cut the paint or surface on the robot before replacing parts on page 118 .	
3	Remove the timing belt from the outer arm.	 xx2100001048

Removing the axis-2 cover

	Action	Note
1	 DANGER Make sure that all supplies for electrical power, hydraulic pressure, and air pressure are turned off.	
2	 CAUTION For robots with protection type Clean Room Always cut the paint with a knife and grind the paint edge when disassembling parts of the robot! See Cut the paint or surface on the robot before replacing parts on page 118 .	

Continues on next page



5 Repair

5.8.2 Replacing the axis-2 gear unit sub-assembly

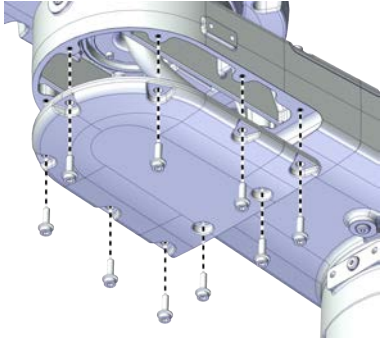

Continued

	Action	Note
3	Remove the screws.	 <p>xx2100000943</p>
4	Remove the cover.	

Pulling out the internal harness from axis-2 gear unit

	Action	Note
1	 DANGER Make sure that all supplies for electrical power, hydraulic pressure, and air pressure are turned off.	
2	 CAUTION For robots with protection type Clean Room Always cut the paint with a knife and grind the paint edge when disassembling parts of the robot! See Cut the paint or surface on the robot before replacing parts on page 118 .	
3	Pull out the internal harness from the axis-2 gear unit.	

Removing the outer arm assembly



	Action	Note
1	 DANGER Make sure that all supplies for electrical power, hydraulic pressure, and air pressure are turned off.	
2	 CAUTION For robots with protection type Clean Room Always cut the paint with a knife and grind the paint edge when disassembling parts of the robot! See Cut the paint or surface on the robot before replacing parts on page 118 .	

Continues on next page

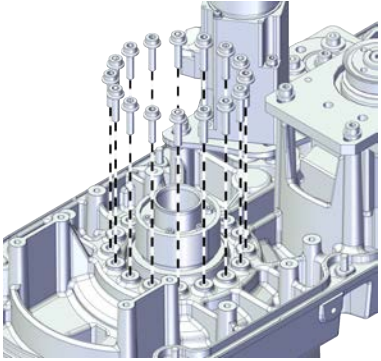
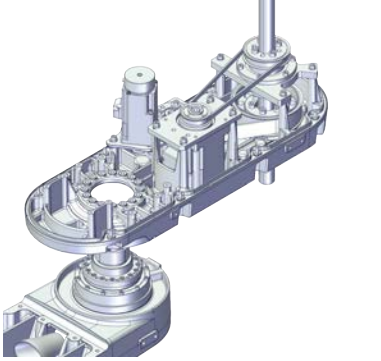
5.8.2 Replacing the axis-2 gear unit sub-assembly
Continued

	Action	Note
3	Remove the screws on the axis -2 gear inside the outer arm.	 <p>xx2100001049</p>
4	Remove the outer arm assembly slightly.	 <p>xx2100001050</p>

Removing the axis-2 gear unit sub-assembly



	Action	Note
1	 DANGER Make sure that all supplies for electrical power, hydraulic pressure, and air pressure are turned off.	
2	 CAUTION For robots with protection type Clean Room Always cut the paint with a knife and grind the paint edge when disassembling parts of the robot! See Cut the paint or surface on the robot before replacing parts on page 118.	

Continues on next page

5 Repair

5.8.2 Replacing the axis-2 gear unit sub-assembly

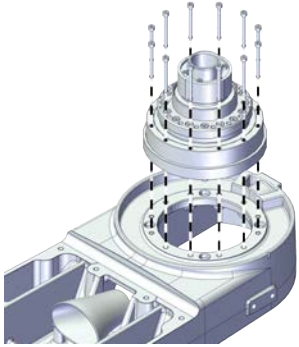

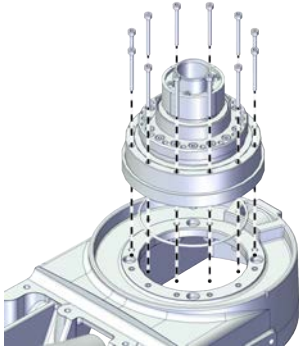
Continued

	Action	Note
3	Remove the screws on the gear to the inner arm.	<p>For robots with protection class IP30 (option 3350-300)</p>  <p>xx2100001182</p> <p>For robots with protection class IP54 (option 3350-540) For robots with protection type Clean Room (option 3351-1) Remove the gear unit and the O-ring through the cable slightly.</p> <p> Tip</p> <p>Check the O-ring and replace it if needed.</p> <p> Tip</p> <p>Wrap the connectors with the masking tape.</p>  <p>xx2100002439</p>
4	Remove the gear unit.	

Refitting the axis-2 gear unit sub-assembly



Use these procedures to refit the axis-2 gear unit sub-assembly.

Refitting the axis-2 gear unit sub-assembly to the inner arm

	Action	Note
1	<p>For robots with protection type Clean Room: Clean the joints that have been opened and wipe the parts free from particles with spirit on a lint free. See Cut the paint or surface on the robot before replacing parts on page 118</p> <p> Note</p> <p>After all repair work, wipe the Clean Room robot free from particles with spirit on a lint free cloth.</p>	
2	<p> CAUTION</p> <p>Whenever parting/mating motor and gearbox, the gears may be damaged if excessive force is used.</p>	

Continues on next page

5.8.2 Replacing the axis-2 gear unit sub-assembly
Continued

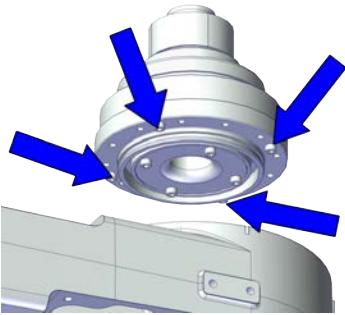
	Action	Note
3	<p>Refit the gear unit according to the location screws.</p> <p> Note</p> <p>For robots with protection class IP54 (option 3350-540) For robots with protection type Clean Room (option 3351-1) Refit the gear unit and the O-ring according to the location pin.</p> <p> Tip</p> <p>Check the O-ring and replace it if needed.</p> <p> Tip</p> <p>When the gear unit is in the right position, you can hear a clear "Click".</p>	 <p>xx2100001183</p>

Continues on next page

5 Repair

5.8.2 Replacing the axis-2 gear unit sub-assembly

Continued

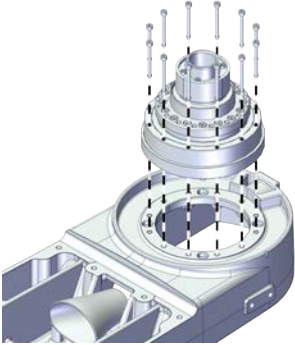
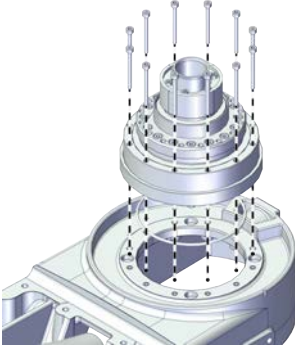



	Action	Note
4	Refit the screws.	<p>Screws: Hex socket head cap screw M3x30 12.9 Lafre 2C2B/FC6.9 (12 pcs)</p> <p>For 450: Tightening torque: 1.6 Nm $\pm 3\%$</p> <p>For 550/650: Tightening torque: 1.8 Nm $\pm 3\%$</p> <p>For robots with protection class IP30 (option 3350-300)</p>  <p>xx2100001182</p> <p>For robots with protection class IP54 (option 3350-540)</p> <p>For robots with protection type Clean Room (option 3351-1)</p>  <p>xx2100002439</p>

Refitting the outer arm to the inner arm

	Action	Note
1	<p>For robots with protection type Clean Room: Clean the joints that have been opened and wipe the parts free from particles with spirit on a lint free. See Cut the paint or surface on the robot before replacing parts on page 118</p> <p> Note</p> <p>After all repair work, wipe the Clean Room robot free from particles with spirit on a lint free cloth.</p>	

Continues on next page

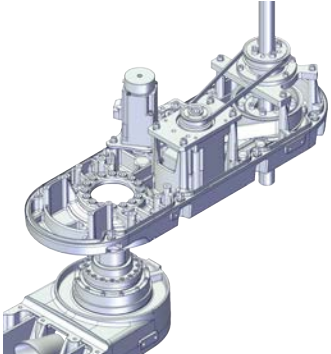
5.8.2 Replacing the axis-2 gear unit sub-assembly
Continued

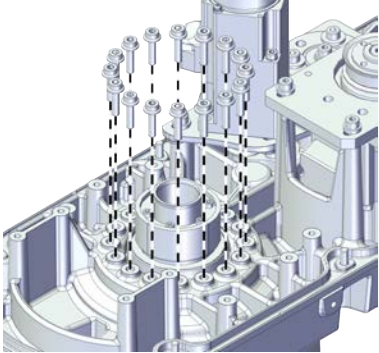
	Action	Note
2	 CAUTION Whenever parting/mating motor and gearbox, the gears may be damaged if excessive force is used.	
3	Refit the outer arm to the axis-2 gear unit on the inner arm. (Location pin?)  Tip When the gear unit is in the right position, you can hear a clear "Click".	 xx2100001050
4	Refit the screws.  Note The two screw holes under the axis-2 belt location are left empty.	Screws: Hex socket head cap screw M4x16 12.9 Lafre 2C2B/FC6.9 (14 pcs) Washers: Spring washer 9x4.3x1 Steel (14 pcs) Tightening torque: 3.5 Nm ±10%  xx2100001049

Refitting the axis-2 motor sub-assembly



	Action	Note
1	For robots with protection type Clean Room: Clean the joints that have been opened and wipe the parts free from particles with spirit on a lint free. See Cut the paint or surface on the robot before replacing parts on page 118  Note After all repair work, wipe the Clean Room robot free from particles with spirit on a lint free cloth.	

Continues on next page

5 Repair

5.8.2 Replacing the axis-2 gear unit sub-assembly

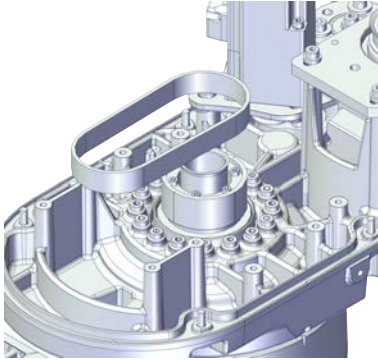
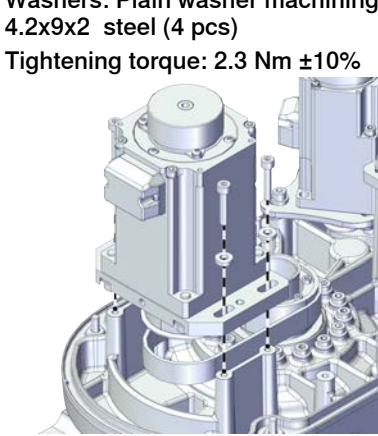
Continued

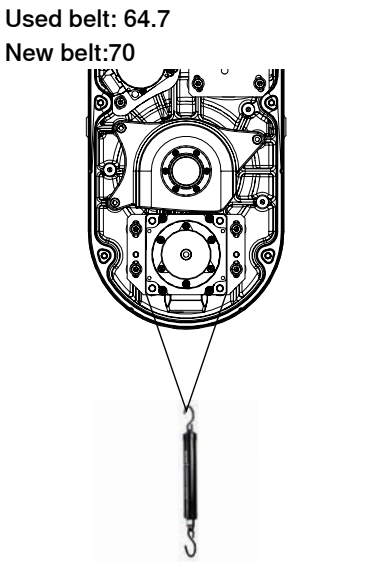
	Action	Note
2	Refit the axis-2 timing belt onto the pulley on the axis-2 gearbox.	 <p>xx2100001048</p>
3	Refit the motor and refit the timing belt to the motor. Ensure that the belt runs correctly in the grooves.	<p>Screws: Hex socket head cap screw M4x20 12.9 Lafre 2C2B/FC6.9 (4 pcs)</p> <p>Washers: Plain washer machining 4.2x9x2 steel (4 pcs)</p> <p>Tightening torque: 2.3 Nm \pm10%</p>
4	Refit the screws and washers without fully tightened.	 <p>xx2100001046</p> <p>Timing belt A2: 3HAC061861-001</p>
5	Hang a strap to the motor.	
6	<p>Use a handheld dynamometer hooking to the strap and pull the dynamometer to make the tension falling in the allowed force range.</p> <p> Note</p> <p>During the measurement, make sure that all interferences that may affect the force are removed. Pay attention to the force application direction.</p> <p> Tip</p> <p>If the ball screw will interfere with the handheld dynamometer, adjust the ball screw manually.</p>	<p>Used belt: 64.7 New belt:70</p>  <p>xx2100001125</p>

Continues on next page

5.8.2 Replacing the axis-2 gear unit sub-assembly
Continued

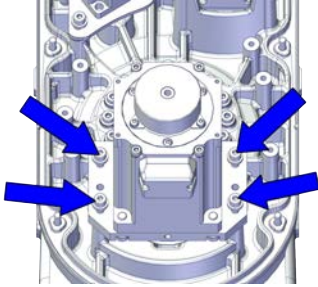
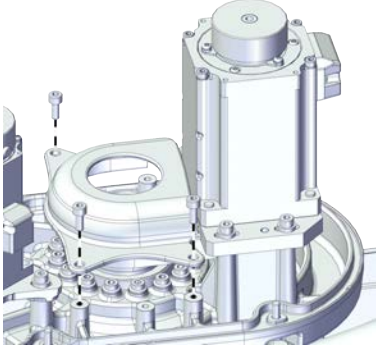
	Action	Note
7	Fasten the screws to the recommended tightening torque.	Tightening torque: 2.3 Nm ±10%  xx2100001176
8	Use a sonic tension meter to measure the timing belt tension.	Used belt: 315 New belt:260
9	If the timing belt tension does not meet the requirement, loosen the motor screws and readjust.	
10	Refit the pulley protection cover and secure with screws.	Screws: Hex socket head cap screw M4x10 12.9 Lafre 2C2B/FC6.9 (3 pcs) Tightening torque: 0.8 Nm  xx2100001047

Inserting the main harness through the axis -2 gearbox position

	Action	Note
1	For robots with protection type Clean Room: Clean the joints that have been opened and wipe the parts free from particles with spirit on a lint free. See Cut the paint or surface on the robot before replacing parts on page 118  Note After all repair work, wipe the Clean Room robot free from particles with spirit on a lint free cloth.	

Continues on next page

5 Repair

5.8.2 Replacing the axis-2 gear unit sub-assembly

Continued

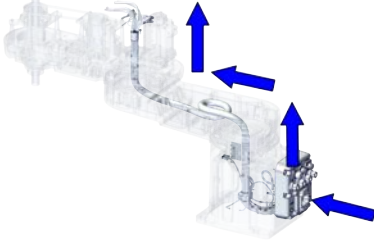
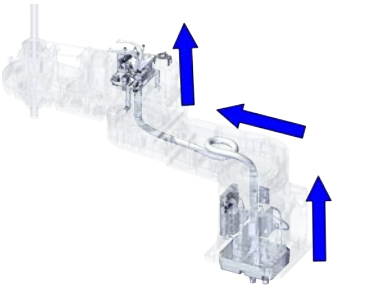





	Action	Note
2	<p>Insert the internal harness into the outer arm through the plastic protection tube and the centre of the axis-2 gearbox.</p> <p> Tip</p> <p>Wrap the connectors with the masking tape.</p>	<p>For rear outlet cable version:</p>  <p>xx2100000955</p> <p>For underneath outlet cable version:</p>  <p>xx2100001206</p>
3	Secure the R2.MP3 and R2.MP4 with cable straps.	

Refitting the cable ferrule and bracket in the outer arm

	Action	Note
1	<p>For robots with protection type Clean Room: Clean the joints that have been opened and wipe the parts free from particles with spirit on a lint free. See Cut the paint or surface on the robot before replacing parts on page 118</p> <p> Note</p> <p>After all repair work, wipe the Clean Room robot free from particles with spirit on a lint free cloth.</p>	
2	Lay the internal harness in a natural state without distortion.	

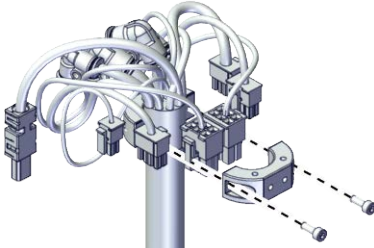
Continues on next page

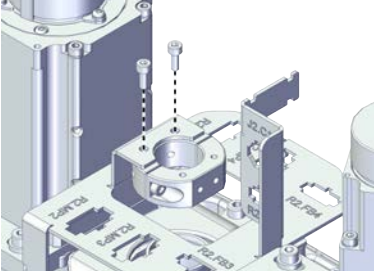
5.8.2 Replacing the axis-2 gear unit sub-assembly
Continued

	Action	Note
3	<p>Refit the cable ferrule and secure it with the screws.</p> <p> Tip</p> <p>The air hoses should face the process hub side.</p> <p> Tip</p> <p>The position with wrapped tape is the marked position for the cable ferrule.</p> <p> Tip</p> <p>Align all the cable ferrules so that the cable is in a natural bending position to avoid twisting.</p>	<p>Screws: Hex socket head cap screw M3x8 12.9 Lafre 2C2B/FC6.9 (2 pcs)</p> <p>Tightening torque: 1.2 Nm ±10%</p>  <p>xx1800002849</p>
4	<p>Secure the cable ferrule to the bracket.</p> <p> Tip</p> <p>Align all the cable ferrules so that the cable is in a natural bending position to avoid twisting.</p> <p> Note</p> <p>The harness are not visible due to the cleanness requirements of the illustration. They are still existing inside the cable ferrule in the actual situation.</p>	<p>Screws: Hex socket head cap screw M3x8 12.9 Lafre 2C2B/FC6.9 (2 pcs)</p> <p>Tightening torque: 1.2 Nm ±10%</p>  <p>xx2100000940</p>
5	<p>Refit the bracket without securing.</p> <p> Tip</p> <p>Do not secure it with the screws before the cable ferrule installed well.</p> <p> Note</p> <p>The harness are not visible due to the cleanness requirements of the illustration. They are still existing inside the cable ferrule in the actual situation.</p>	







Continues on next page

5 Repair

5.8.2 Replacing the axis-2 gear unit sub-assembly

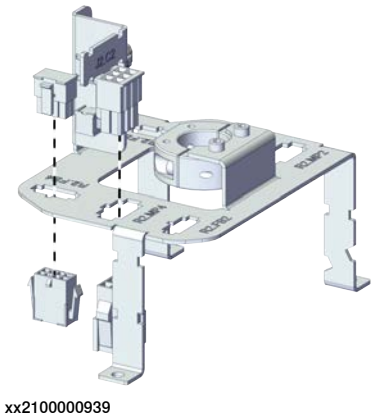

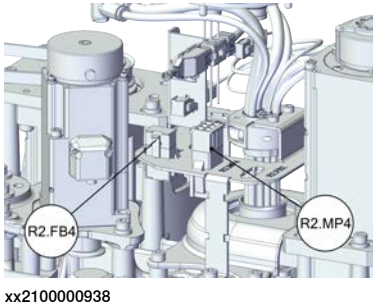



Continued

Reconnecting the connectors for axis-4 motor

	Action	Note
1	<p>For robots with protection type Clean Room: Clean the joints that have been opened and wipe the parts free from particles with spirit on a lint free. See Cut the paint or surface on the robot before replacing parts on page 118</p> <p> Note</p> <p>After all repair work, wipe the Clean Room robot free from particles with spirit on a lint free cloth.</p>	
	<p>Insert the female head of the connectors to the bracket accordingly.</p> <p> Tip</p> <p>The mistake proofing measure has been applied to the connectors, the connectors may be damaged if excessive force is used.</p> <p> Note</p> <p>The harness are not visible due to the cleanness requirements of the illustration. They are still existing inside the cable ferrule in the actual situation.</p>	 <p>xx210000939</p>
2	<p>Reconnect the connectors.</p> <ul style="list-style-type: none"> • R2.MP4 • R2.FB4 <p> Tip</p> <p>See the number markings on the connectors for help to find the corresponding connector.</p>	 <p>xx210000938</p>
3	<p>Route the cabling on the axis-4 motor.</p> <p> CAUTION</p> <p>Correct cable routing is highly important. If the cables are routed and secured incorrectly the cables can be damaged.</p>	

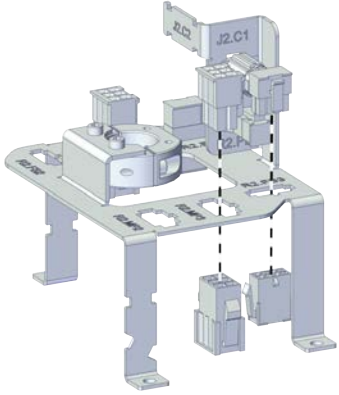
Continues on next page

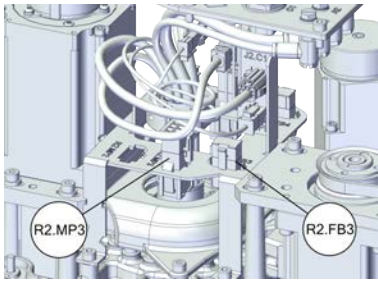
Reconnecting the connectors for axis-3 motor

	Action	Note
1	<p>For robots with protection type Clean Room: Clean the joints that have been opened and wipe the parts free from particles with spirit on a lint free. See Cut the paint or surface on the robot before replacing parts on page 118</p> <p> Note</p> <p>After all repair work, wipe the Clean Room robot free from particles with spirit on a lint free cloth.</p>	
2	<p>Insert the female head of the connectors to the bracket accordingly.</p> <p> Tip</p> <p>The mistake proofing measure has been applied to the connectors, the connectors may be damaged if excessive force is used.</p> <p> Note</p> <p>The harness are not visible due to the cleanness requirements of the illustration. They are still existing inside the cable ferrule in the actual situation.</p>	 <p>xx2100000937</p>
3	<p>Reconnect the connectors.</p> <ul style="list-style-type: none"> • R2.MP3 • R2.FB3 <p> Tip</p> <p>See the number markings on the connectors for help to find the corresponding connector.</p>	 <p>xx2100000936</p>
4	<p>Route the cabling on the axis-3 motor.</p> <p> CAUTION</p> <p>Correct cable routing is highly important. If the cables are routed and secured incorrectly the cables can be damaged.</p>	







Continues on next page

5 Repair

5.8.2 Replacing the axis-2 gear unit sub-assembly

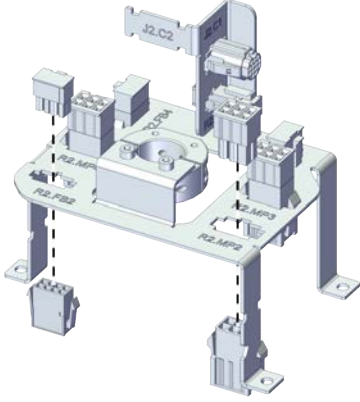

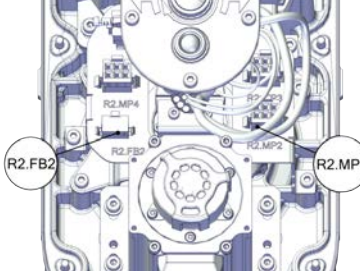



Continued

Reconnecting the connectors for axis-2 motor

	Action	Note
1	<p>For robots with protection type Clean Room: Clean the joints that have been opened and wipe the parts free from particles with spirit on a lint free. See Cut the paint or surface on the robot before replacing parts on page 118</p> <p> Note</p> <p>After all repair work, wipe the Clean Room robot free from particles with spirit on a lint free cloth.</p>	
2	<p>Insert the female head of the connectors to the bracket accordingly.</p> <p> Tip</p> <p>The mistake proofing measure has been applied to the connectors, the connectors may be damaged if excessive force is used.</p> <p> Note</p> <p>The harness are not visible due to the cleanness requirements of the illustration. They are still existing inside the cable ferrule in the actual situation.</p>	 <p>xx2100000935</p>
3	<p>Reconnect the connectors.</p> <ul style="list-style-type: none"> • R2.MP2 • R2.FB2 <p> Tip</p> <p>See the number markings on the connectors for help to find the corresponding connector.</p>	 <p>xx2100000934</p>
4	<p>Route the cabling behind the axis-2 motor.</p> <p> CAUTION</p> <p>Correct cable routing is highly important. If the cables are routed and secured incorrectly the cables can be damaged.</p>	

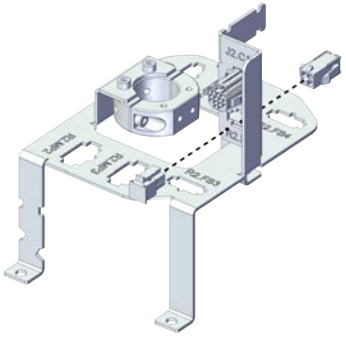
Continues on next page

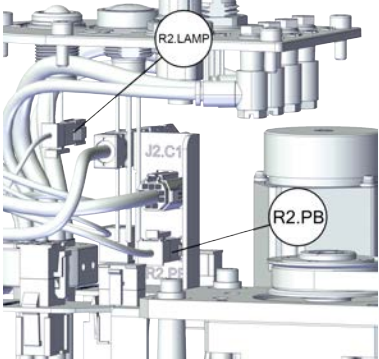
Reconnecting the connector for PB

	Action	Note
1	<p>For robots with protection type Clean Room: Clean the joints that have been opened and wipe the parts free from particles with spirit on a lint free. See Cut the paint or surface on the robot before replacing parts on page 118</p> <p> Note</p> <p>After all repair work, wipe the Clean Room robot free from particles with spirit on a lint free cloth.</p>	
2	<p>Insert the female head of the PB connector to the bracket accordingly.</p> <p> Tip</p> <p>The mistake proofing measure has been applied to the connectors, the connectors may be damaged if excessive force is used.</p> <p> Note</p> <p>The harness are not visible due to the cleanness requirements of the illustration. They are still existing inside the cable ferrule in the actual situation.</p>	 <p>xx2100001031</p>
3	<p>Reconnect the connector.</p> <ul style="list-style-type: none"> • R2.PB • R2.LAMP <p> Tip</p> <p>See the number markings on the connectors for help to find the corresponding connector.</p>	 <p>xx2100001030</p>
4	<p>Route and secure the cabling with cable straps if needed.</p> <p> CAUTION</p> <p>Correct cable routing is highly important. If the cables are routed incorrectly the cables can be damaged.</p>	



Continues on next page

5 Repair

5.8.2 Replacing the axis-2 gear unit sub-assembly







Continued

Reconnecting the air hoses, CP/CS cabling and Ethernet cabling (if equipped)

	Action	Note
1	<p>For robots with protection type Clean Room: Clean the joints that have been opened and wipe the parts free from particles with spirit on a lint free. See Cut the paint or surface on the robot before replacing parts on page 118</p> <p> Note</p> <p>After all repair work, wipe the Clean Room robot free from particles with spirit on a lint free cloth.</p>	
2	<p>Route the air hoses on the process hub behind the bracket.</p> <p> CAUTION</p> <p>Correct cable routing is highly important. If the cables are routed and secured incorrectly the cables can be damaged.</p>	

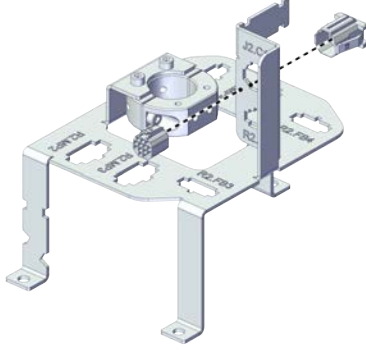
Continues on next page

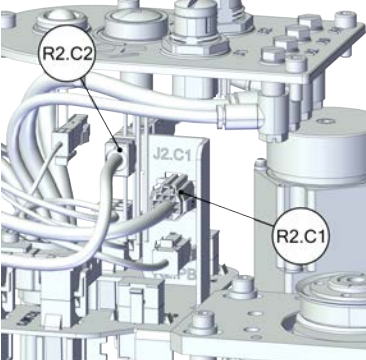
5.8.2 Replacing the axis-2 gear unit sub-assembly
Continued

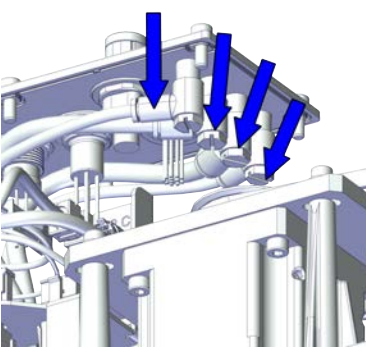
	Action	Note
3	<p>Insert the female head of the C1 cabling connector to the bracket accordingly.</p> <p> Tip</p> <p>The mistake proofing measure has been applied to the connectors, the connectors may be damaged if excessive force is used.</p> <p> Note</p> <p>The harness are not visible due to the cleanness requirements of the illustration. They are still existing inside the cable ferrule in the actual situation.</p>	 <p>xx2100001034</p>
4	<p>For robots with C1 cabling</p> <p>Reconnect the connector.</p> <ul style="list-style-type: none"> • R2.C1 <p> Tip</p> <p>See the number markings on the air hoses for help to find the corresponding air hoses.</p> <p>The air hoses with the same number connect to the same L-shaped connector.</p>	 <p>xx2100001033</p>
5	<p>For robots with C2 cabling</p> <p>Reconnect the connector.</p> <ul style="list-style-type: none"> • R1.C2 <p> Tip</p> <p>See the number markings on the air hoses for help to find the corresponding air hoses.</p> <p>The air hoses with the same number connect to the same L-shaped connector.</p>	
6	<p>Secure the C2 cabling to the C2 bracket with the cable straps.</p>	
7	<p>Reconnect the air hoses in a cross pattern with the L-shaped connectors.</p> <p> Tip</p> <p>See the number markings on the air hoses for help to find the corresponding air hoses.</p> <p>The air hoses with the same number connect to the same Y-shaped connector.</p>	 <p>xx2100001032</p>

Continues on next page



5 Repair

5.8.2 Replacing the axis-2 gear unit sub-assembly

Continued

	Action	Note
8	<p>Route and secure the cabling with cable straps if needed.</p> <p> CAUTION</p> <p>Correct cable routing is highly important. If the cables are routed and secured incorrectly the cables can be damaged.</p>	

Securing the bracket in the outer arm

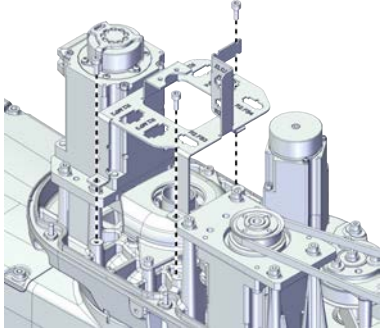

	Action	Note
1	<p>For robots with protection type Clean Room: Clean the joints that have been opened and wipe the parts free from particles with spirit on a lint free. See Cut the paint or surface on the robot before replacing parts on page 118</p> <p> Note</p> <p>After all repair work, wipe the Clean Room robot free from particles with spirit on a lint free cloth.</p>	
2	<p>Refit the bracket.</p> <p> Tip</p> <p>Do not secure it with the screws before the cable ferrule installed well.</p> <p> Note</p> <p>The harness are not visible due to the cleanness requirements of the illustration. They are still existing inside the cable ferrule in the actual situation.</p>	<p>Screws: Hex socket head cap screw M4x10 12.9 Lafre 2C2B/FC6.9 (3 pcs)</p> <p>Tightening torque: 1.2 Nm \pm10%</p>  <p>xx2100000941</p>

Refitting the cover of the outer arm

	Action	Note
1	<p>For robots with protection type Clean Room: Clean the joints that have been opened and wipe the parts free from particles with spirit on a lint free. See Cut the paint or surface on the robot before replacing parts on page 118</p> <p> Note</p> <p>After all repair work, wipe the Clean Room robot free from particles with spirit on a lint free cloth.</p>	

Continues on next page

5.8.2 Replacing the axis-2 gear unit sub-assembly
Continued

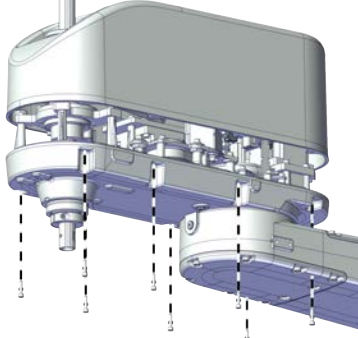
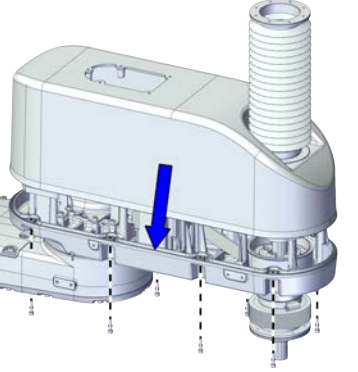
	Action	Note
2	<p>Refit the cover.</p> <p> Note</p> <p>For robots with protection class IP54 (option 3350-540)</p> <p>For robots with protection type Clean Room (option 3351-1)</p> <p>Refit the cover with bellow.</p> <p>Check the gasket for the outer arm cover.</p> <p> Tip</p> <p>Replace the gasket if needed.</p> <p> CAUTION</p> <p>The gasket is in the outer arm.</p>	<p>Screw: Hex socket head cap screw M4x16 12.9 Lafre 2C2B/FC6.9 (8 pcs)</p> <p>Tightening torque: 2 Nm ±10%</p> <p>For robots with protection class IP30 (option 3350-300)</p>  <p>xx210000933</p>
3	<p>Refit the screws.</p>	<p>For robots with protection class IP54 (option 3350-540)</p> <p>For robots with protection type Clean Room (option 3351-1)</p>  <p>xx2100002427</p>

For Clean Room/ IP54 robots

Refitting the top cover and the flange with bearing



	Action	Note
1	<p>For robots with protection type Clean Room:</p> <p>Clean the joints that have been opened and wipe the parts free from particles with spirit on a lint free. See Cut the paint or surface on the robot before replacing parts on page 118</p> <p> Note</p> <p>After all repair work, wipe the Clean Room robot free from particles with spirit on a lint free cloth.</p>	

Continues on next page

5 Repair

5.8.2 Replacing the axis-2 gear unit sub-assembly

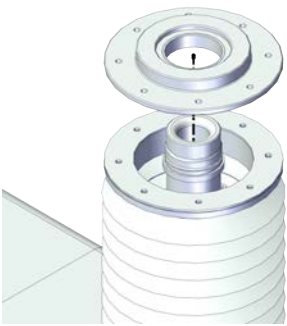
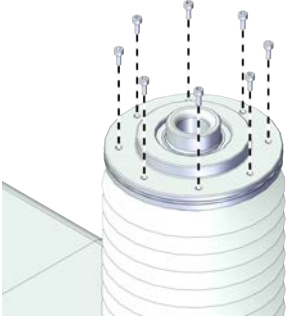
Continued

	Action	Note
2	<p>For robots with protection class IP54 (option 3350-540)</p> <p>For robots with protection type Clean Room (option 3351-1)</p> <p>Install the flange with bearing to the extension shaft.</p>	 <p>xx2100002402</p>
3	<p>For robots with protection class IP54 (option 3350-540)</p> <p>For robots with protection type Clean Room (option 3351-1)</p> <p>Refit the screws to the flange with bearing.</p>	<p>Screws: Hex socket head cap screw M2.5x6 12.9 Lafre 2C2B/FC6.9 (8 pcs)</p> <p>Tightening torque: 0.8 Nm \pm10%</p>  <p>xx2100002401</p>
4	<p>For robots with protection class IP54 (option 3350-540)</p> <p>For robots with protection type Clean Room (option 3351-1)</p> <p>Refit the top cover to the ball screw.</p> <p> Tip</p> <p>The top surface of the cover should be flush with the top end of the ball screw.</p>	 <p>xx2100002399</p>

Continues on next page

5.8.2 Replacing the axis-2 gear unit sub-assembly
Continued

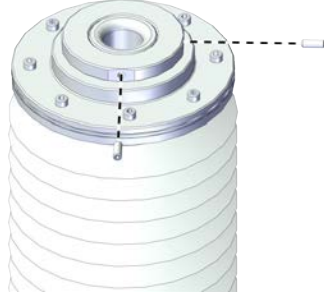
	Action	Note
5	<p>For robots with protection class IP54 (option 3350-540)</p> <p>For robots with protection type Clean Room (option 3351-1)</p> <p>Refit the locking screws.</p>	<p>Screws: Hexagon socket set screws with flat point, ISO 4026 stainless steel M3x8 (2 pcs)</p> <p>Tightening torque: 0.4 Nm \pm10%</p>  <p>xx2100002398</p>

Securing the process hub to outer arm cover



	Action	Note
1	<p>For robots with protection type Clean Room:</p> <p>Clean the joints that have been opened and wipe the parts free from particles with spirit on a lint free. See Cut the paint or surface on the robot before replacing parts on page 118</p> <p> Note</p> <p>After all repair work, wipe the Clean Room robot free from particles with spirit on a lint free cloth.</p>	
2	Insert the process hub from the outer arm cover.	

Continues on next page



5 Repair

5.8.2 Replacing the axis-2 gear unit sub-assembly

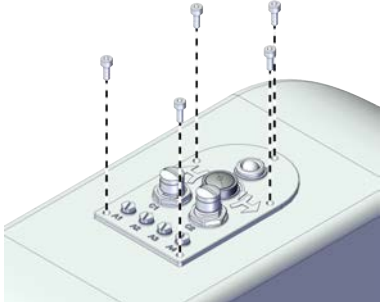
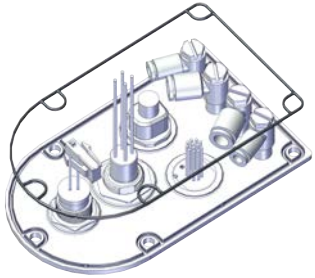
Continued



	Action	Note
3	<p>Secure the process hub to the outer arm cover with the screws.</p> <p> Note</p> <p>For robots with protection class IP54 (option 3350-540)</p> <p>For robots with protection type Clean Room (option 3351-1)</p> <p>Check the gasket for the process hub.</p> <p> Tip</p> <p>Replace the gasket if needed.</p> <p> CAUTION</p> <p>Be aware of the cabling that is attached to the cover! The cover can not be removed completely until the connectors are disconnected, as shown in following steps.</p>	<p>Screws: Hex socket head cap screw M4x10 12.9 Lafre 2C2B/FC6.9 (5 pcs)</p> <p>Tightening torque: 2.6 Nm±10%</p> <p>For robots with protection class IP30 (option 3350-300)</p>  <p>xx2100000932</p> <p>For robots with protection class IP54 (option 3350-540)</p> <p>For robots with protection type Clean Room (option 3351-1)</p>  <p>xx2100002438</p>

Refitting the axis-2 cover

	Action	Note
1	<p> DANGER</p> <p>Make sure that all supplies for electrical power, hydraulic pressure, and air pressure are turned off.</p>	
2	<p> CAUTION</p> <p>For robots with protection type Clean Room</p> <p>Always cut the paint with a knife and grind the paint edge when disassembling parts of the robot! See Cut the paint or surface on the robot before replacing parts on page 118.</p>	

Continues on next page

5.8.2 Replacing the axis-2 gear unit sub-assembly
Continued

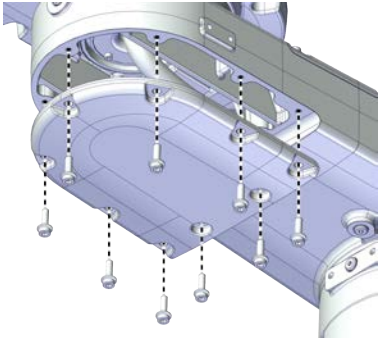
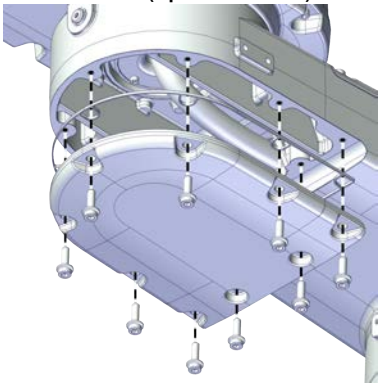
	Action	Note
3	<p>Refit the cover.</p> <p> Note</p> <p>For robots with protection class IP54 (option 3350-540)</p> <p>For robots with protection type Clean Room (option 3351-1)</p> <p>Check the gasket for the cover before refitting the cover.</p> <p> Tip</p> <p>Replace the gasket if needed.</p>	<p>Screws: Hex socket head cap flange screw M5x16 12.9 Lafre 2C2B/FC6.9+PrO-COat111 (9 pcs)</p> <p>Tightening torque: 1.2 Nm ±10%</p> <p>For robots with protection class IP30 (option 3350-300)</p> 
4	<p>Refit the screws.</p>	<p>xx210000943</p> <p>For robots with protection class IP54 (option 3350-540)</p> <p>For robots with protection type Clean Room (option 3351-1)</p>  <p>xx2100002451</p>

Concluding procedure

	Action	Note
1	<p>For robots with protection type Clean Room:</p> <p>Seal and paint the joints that have been opened. See Cut the paint or surface on the robot before replacing parts on page 118</p> <p> Note</p> <p>After all repair work, wipe the Clean Room robot free from particles with spirit on a lint free cloth.</p>	
2	<p>Recalibrate the robot.</p>	<p>Calibration is detailed in section Calibration on page 945.</p>

Continues on next page

5 Repair

5.8.2 Replacing the axis-2 gear unit sub-assembly

Continued

	Action	Note
3	 DANGER Make sure all safety requirements are met when performing the first test run.	

6 Calibration

6.1 Introduction to calibration

6.1.1 Introduction and calibration terminology

Calibration information

This chapter includes general information about the recommended calibration methods and also the detailed procedures for updating the revolution counters, checking the calibration position etc.

Detailed instructions of how to perform Axis Calibration are given on the FlexPendant during the calibration procedure. To prepare calibration with Axis Calibration method, see [Calibrating with Axis Calibration method on page 956](#).

Calibration terminology

Term	Definition
Calibration method	A collective term for several methods that might be available for calibrating the ABB robot. Each method contains calibration routines.
Synchronization position	Known position of the complete robot where the angle of each axis can be checked against visual synchronization marks.
Calibration position	Known position of the complete robot that is used for calibration of the robot.
Standard calibration	A generic term for all calibration methods that aim to move the robot to calibration position.
Fine calibration	A calibration routine that generates a new zero position of the robot.
Reference calibration	<p>A calibration routine that in the first step generates a reference to current zero position of the robot. The same calibration routine can later on be used to recalibrate the robot back to the same position as when the reference was stored.</p> <p>This routine is more flexible compared to fine calibration and is used when tools and process equipment are installed.</p> <p>Requires that a reference is created before being used for recalibrating the robot.</p> <p>Requires that the robot is dressed with the same tools and process equipment during calibration as during creation of the reference values.</p>
Update revolution counter	A calibration routine to make a rough calibration of each manipulator axis.
Synchronization mark	Visual marks on the robot axes. When marks are aligned, the robot is in synchronization position.

6 Calibration

6.1.2 Calibration methods

6.1.2 Calibration methods

Overview

This section specifies the different types of calibration and the calibration methods that are supplied by ABB.

Types of calibration

Type of calibration	Description	Calibration method
Standard calibration	The calibrated robot is positioned at calibration position. Standard calibration data is found on the SMB (serial measurement board) or EIB in the robot.	Axis Calibration ⁱ
Absolute accuracy calibration (optional)	Based on standard calibration, and besides positioning the robot at synchronization position, the Absolute accuracy calibration also compensates for: <ul style="list-style-type: none">• Mechanical tolerances in the robot structure• Deflection due to load Absolute accuracy calibration focuses on positioning accuracy in the Cartesian coordinate system for the robot. Absolute accuracy calibration data is found on the SMB (serial measurement board) in the robot. A robot calibrated with Absolute accuracy has the option information printed on its name plate. To regain 100% Absolute accuracy performance, the robot must be recalibrated for absolute accuracy after repair or maintenance that affects the mechanical structure.	CalibWare

ⁱ Only axes 1 and 2 can be calibrated using Axis Calibration method.

Brief description of calibration methods

Axis Calibration method

Axis Calibration is a standard calibration method for calibration of IRB 920. It is the recommended method in order to achieve proper performance.

The following routines are available for the Axis Calibration method:

- Fine calibration
- Update revolution counters
- Reference calibration

The calibration equipment for Axis Calibration is delivered as a toolkit.

An introduction to the calibration method is given in this manual, see [Calibrating with Axis Calibration method on page 956](#).

The actual instructions of how to perform the calibration procedure and what to do at each step is given on the FlexPendant. You will be guided through the calibration procedure, step by step.

Continues on next page

CalibWare - Absolute Accuracy calibration

The CalibWare tool guides through the calibration process and calculates new compensation parameters. This is further detailed in the *Application manual - CalibWare Field*.

If a service operation is done to a robot with the option Absolute Accuracy, a new absolute accuracy calibration is required in order to establish full performance. For most cases after replacements that do not include taking apart the robot structure, standard calibration is sufficient.

The Absolute Accuracy option varies according to the robot mounting position. This is printed on the robot name plate for each robot. The robot must be in the correct mounting position when it is recalibrated for absolute accuracy.

References

Article numbers for the calibration tools are listed in the section [Special tools on page 997](#).

6 Calibration

6.1.3 When to calibrate

6.1.3 When to calibrate

When to calibrate

The system must be calibrated if any of the following situations occur.

The resolver values are changed

If resolver values are changed, the robot must be re-calibrated using the calibration methods supplied by ABB. Calibrate the robot carefully with standard calibration, according to information in this manual.

If the robot has *absolute accuracy* calibration, it is also recommended, but not always necessary to calibrate for new absolute accuracy.

The resolver values will change when parts affecting the calibration position are replaced on the robot, for example motors or parts of the transmission.

The revolution counter memory is lost

If the revolution counter memory is lost, the counters must be updated. See [Updating revolution counters on page 952](#). This will occur when:

- The battery is discharged
- A resolver error occurs
- The signal between a resolver and measurement board is interrupted
- A robot axis is moved with the control system disconnected

The revolution counters must also be updated after the robot and controller are connected at the first installation.

The robot is rebuilt

If the robot is rebuilt, for example, after a crash or when the reachability of a robot is changed, it needs to be re-calibrated for new resolver values.

If the robot has *absolute accuracy* calibration, it needs to be calibrated for new absolute accuracy.

6.2 Synchronization marks and axis movement directions

6.2.1 Synchronization marks and synchronization position for axes

Introduction

This section shows the position of the synchronization marks and the synchronization position for each axis.

Continues on next page

6 Calibration

6.2.1 Synchronization marks and synchronization position for axes

Continued

Synchronization marks, IRB 920

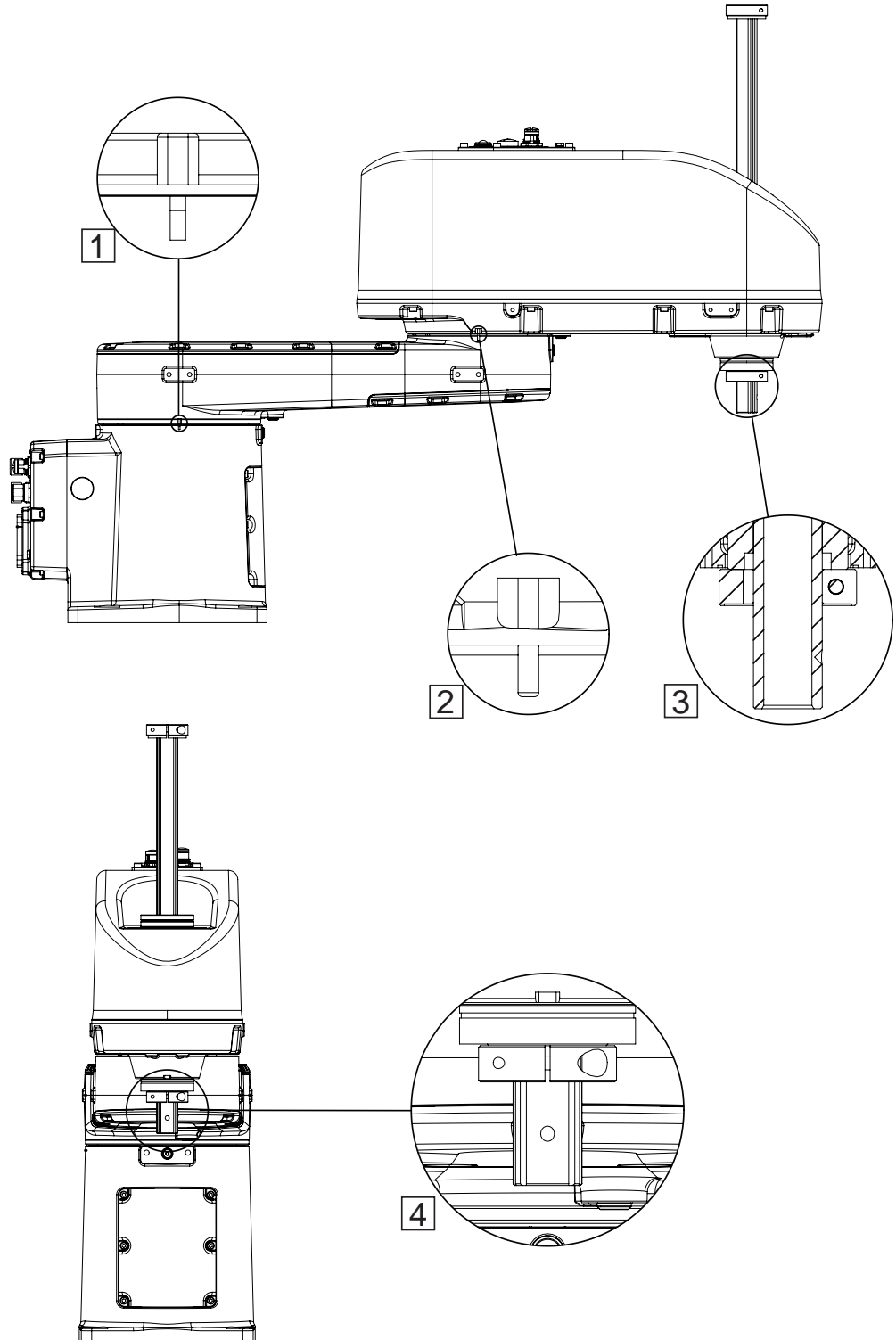

xx2000001163

6.2.2 Calibration movement directions for all axes

Overview

When calibrating, the axis must consistently be run towards the calibration position in the same direction in order to avoid position errors caused by backlash in gears and so on. Positive directions are shown in the graphic below.

Calibration service routines will handle the calibration movements automatically and these might be different from the positive directions shown below.

Manual movement directions

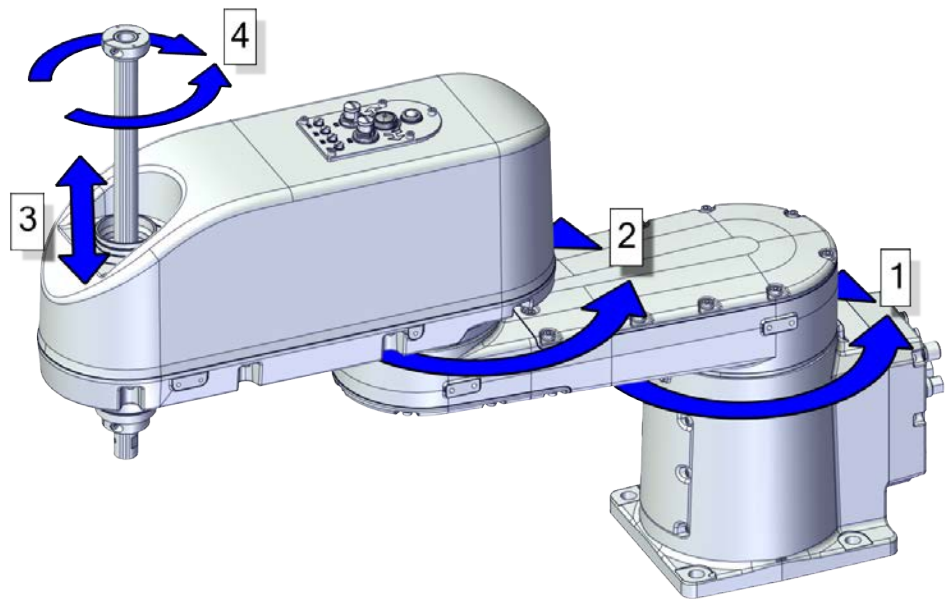

xx210000931

6 Calibration

6.3.1 Updating revolution counters on OmniCore robots

6.3 Updating revolution counters

6.3.1 Updating revolution counters on OmniCore robots

Introduction

This section describes how to do a rough calibration of each manipulator axis by updating the revolution counter for each axis, using the FlexPendant.

Coupled axes

When updating the revolution counters for a coupled axis, also the axis it is coupled to needs to be at its synchronization position for the update to be correct; i.e. axis 4 needs to be in synchronization position when updating axis 3.

With reversed coupled joints, the relationship is the opposite, i.e. axis 4 needs to be in synchronization position to update axis 3.

Coupled axes	IRB 920
Axis 4, 3	x

Step 1 - Manually running the manipulator to the synchronization position

Use this procedure to manually run the manipulator to the synchronization position.

	Action	Note
1	Select axis-by-axis motion mode.	
2	Jog the manipulator to align the synchronization marks.	See Synchronization marks and synchronization position for axes on page 949 .
3	When all axes are positioned, update the revolution counter.	Step 2 - Updating the revolution counter with the FlexPendant on page 955 .

Continues on next page

Correct synchronization position of axes 3 and 4

When jogging the manipulator to synchronization position, it is extremely important to make sure that axes 3 and 4 are positioned correctly.



Note

At delivery the manipulator is in the correct position. Do NOT shift axis 3 or rotate axis 4 at power up before the revolution counters are updated.

If axis 4 is rotated one or more turns from its calibration position before updating the revolution counter, the correct calibration position will be lost due to non-integer gear ratio. This will further affect the calibration position of axis 3.

Continues on next page

6 Calibration

6.3.1 Updating revolution counters on OmniCore robots

Continued

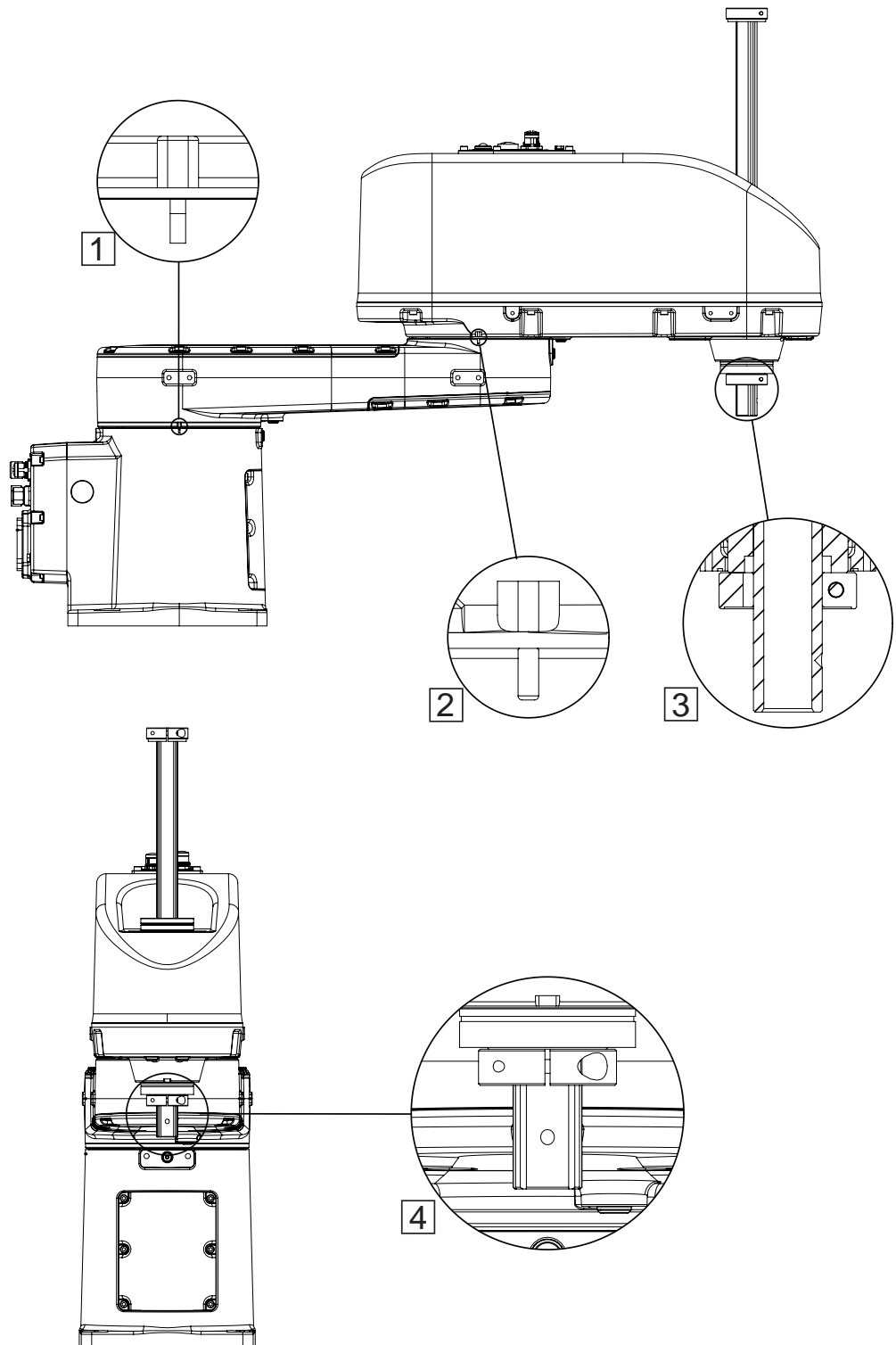

xx2000001163

For robots with protection class IP54 and protection type Clean Room

Make sure the opening gap on the lower mechanical stopper is aligned with the notch on the outer arm cover, and the convex edge surface on the mechanical stopper is aligned with the lowest surface on the outer arm cover.



Continues on next page

Step 2 - Updating the revolution counter with the FlexPendant

**Note**

Revolution counters of axes 3 and 4 must be updated together.

Use this procedure to update the revolution counter with the FlexPendant (OmniCore).

	Action
1	On the start screen, tap Calibrate .
2	Select Calibration from the menu. The Mechanical Units page displays a list of available mechanical units.  Note This step is required only if you are not already in the Mechanical Unit page when you open Calibrate .  Note The Mechanical Unit page is displayed only if there are more than one mechanical unit available. Otherwise, the calibration summary page for the available mechanical unit is displayed.
3	Select the mechanical unit for which revolution counter need to be updated.
4	The calibration summary page for the selected mechanical unit is displayed. Calibration method used at factory for each axis is shown, as well as calibration method used during last field calibration.
5	Tap Calibration Methods on the right pane. The calibration options are displayed.
6	Tap Revolution Counters .
7	In the Selection column select the axes for which revolution counters need to be updated.
8	Tap Update . A dialog box is displayed, warning that the updating operation cannot be undone: <ul style="list-style-type: none"> • Tap Update to proceed with updating the revolution counters. • Tap Cancel to cancel updating the revolution counters. Tapping Update and a confirmation window is displayed.
9	Tap OK . The revolution counter for the selected axes is updated.
10	 CAUTION If a revolution counter is incorrectly updated, it will cause incorrect manipulator positioning, which in turn may cause damage or injury! Check the synchronization position very carefully after each update. See Checking the synchronization position on page 976 .

6 Calibration

6.4.1 Description of Axis Calibration

6.4 Calibrating with Axis Calibration method

6.4.1 Description of Axis Calibration

Instructions for Axis Calibration procedure given on the FlexPendant

The actual instructions of how to perform the calibration procedure and what to do at each step is given on the FlexPendant. You will be guided through the calibration procedure, step by step.

This manual contains a brief description of the method, additional information to the information given on the FlexPendant, article number for the tools and images of where to fit the calibration tools on the robot.

Overview of the Axis Calibration procedure

The Axis Calibration procedure applies to all axes, and is performed on one axis at the time. The robot axes are both manually and automatically moved into position, as instructed on the FlexPendant.

A fixed calibration pin/bushing is installed on each robot axis at delivery.

The Axis Calibration procedure described roughly:

- 1 A removable calibration tool is inserted by the operator into a calibration bushing on the axis chosen for calibration, according to instructions on the FlexPendant.



WARNING

Calibrating the robot with Axis Calibration requires special calibration tools from ABB. Using other pins in the calibration bushings may cause severe damage to the robot and/or personnel.



WARNING

The calibration tool must be fully inserted into the calibration bushing, until the steel spring ring snaps into place.

- 2 During the calibration procedure, RobotWare moves the robot axis chosen for calibration so that the calibration tools get into contact. RobotWare records values of the axis position and repeats the coming-in-contact procedure several times to get an exact value of the axis position.



WARNING

Risk of pinching! The contact force for large robots can be up to 150 kg. Keep a safe distance to the robot.

- 3 The axis position is stored in RobotWare with an active choice from the operator.

Continues on next page

Routines in the calibration procedure

The following routines are available in the Axis Calibration procedure, given at the beginning of the procedure on the FlexPendant.

Fine calibration routine

Choose this routine to calibrate the robot when there are no tools, process cabling or equipment fitted to the robot.

Reference calibration routine

Choose this routine to create reference values and to calibrate the robot when the robot is dressed with tools, process cabling or other equipment.



Note

When calibrating the robot with the reference calibration routine, the robot must be dressed with the same tools, process cabling and any other equipment as when the reference values were created.

If calibrating the robot with reference calibration there must be reference values created before repair is made to the robot, if values are not already available. Creating new values requires possibility to move the robot. The reference values contain positions of all axes, torque of axes and technical data about the tool installed. A benefit with reference calibration is that the current state of the robot is stored and not the state when the robot left the ABB factory. The reference value will be named according to tool name, date etc.

Follow the instructions given in the reference calibration routine on the FlexPendant to create reference values.

When reference calibration is performed, the robot is restored to the status given by the reference values.

Update revolution counters

Choose this routine to make a rough calibration of each manipulator axis by updating the revolution counter for each axis, using the FlexPendant.

Validation

In the mentioned routines, it is also possible to validate the calibration data.

Position of robot axes

The robot axes should be positioned close to 0 degrees before commencing the calibration program. The axis chosen for calibration is then automatically run by the calibration program to its exact calibration position during the calibration procedure.

It is possible to position some of the other axes in positions different from 0 degrees. Information about which axes are allowed to be jogged is given on the FlexPendant.

Continues on next page

6 Calibration

6.4.1 Description of Axis Calibration

Continued

These axes are marked with **Unrestricted** in the FlexPendant window. Also the following table shows the dependencies between the axes.

Requirements for axis positioning during calibration

Required position of axis	Axis to calibrate					
	Axis 1	Axis 2	Axis 3	Axis 4	Axis 5	Axis 6
Axis 1	-	*				
Axis 2	*	-				

-	Axis to be calibrated
*	Unrestricted. Axis is allowed to be jogged to other position than 0 degrees.
0	Axis must be put in position 0 degrees.

System containing SafeMove

SafeMove will lose its synchronization to the controller if a new calibration is done. New calibration values have to be downloaded to SafeMove, and a new SafeMove calibration has to be done. Make sure that the user rights admit to change the safety settings and to synchronize SafeMove.

6.4.2 Calibration tools for Axis Calibration

Calibration tool set

The calibration tools used for Axis Calibration are designed to meet requirements for calibration performance, durability and safety in case of accidental damage.

The calibration tool will eventually break from fatigue after longer period of use and then needs to be replaced. There is no risk for bad calibrations as long as the calibration tool is in one piece.



WARNING

Calibrating the robot with Axis Calibration requires special calibration tools from ABB. Using other pins in the calibration bushings may cause severe damage to the robot and/or personnel.

Equipment, etc.	Article number	Note
Calibration toolbox, Axis Calibration	3HAC055412-001	Delivered as a set of calibration tools. Required if Axis Calibration is the valid calibration method for the robot.

Examining the calibration tool

Check prior to usage

Before using the calibration tool, make sure that the tube insert, the plastic protection and the steel spring ring are present.



WARNING

If any part is missing or damaged, the tool must be replaced immediately.

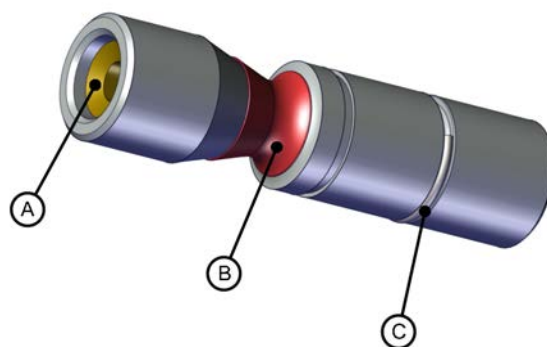

xx1500001914

A	Tube insert
B	Plastic protection
C	Steel spring ring

Continues on next page

6 Calibration

6.4.2 Calibration tools for Axis Calibration

Continued

Periodic check of the calibration tool

If including the calibration tool in a local periodic check system, the following measures should be checked.

- Outer diameter within $\varnothing 12g4$ mm, $\varnothing 8g4$ mm or $\varnothing 6g5$ mm (depending on calibration tool size).
- Straightness within 0.005 mm.

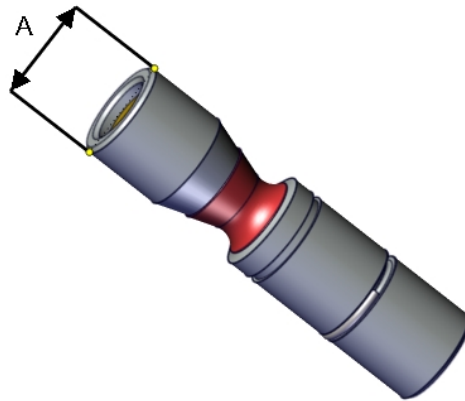

xx150000951

A	Outer diameter
---	----------------

Identifying the calibrating tools

It is possible to make the calibration tool identifiable with, for example, an RFID chip. The procedure of how to install an RFID chip is described below.



Note

The tool identifier is NOT delivered from ABB, it is a customized solution.

	Action	Note
1	<p>It is possible to use any RFID solution, with the correct dimensions. ABB has verified function on some suppliers fulfilling the requirements of NFC compatible devices (13.56 Mhz) according to ISO 14443 or ISO 15693.</p> <p>Note</p> <p>The maximum dimensions on the RFID chip must not exceed $\varnothing 7.9$ mm x 8.0 mm, $\varnothing 5.9$ mm x 8.0 mm or $\varnothing 3.9$ mm x 8.0 mm (depending on calibration tool size).</p>	
2	<p>There is a cavity on one end of the calibration tool in which the RFID chip can be installed.</p> <p>Install the RFID chip according to supplier instructions.</p> <p>Install the chip in flush with the tool end.</p>	

6.4.3 Installation locations for the calibration tools

Location of fixed calibration items

This section shows how the robot is equipped with items for installation of calibration tools for Axis Calibration (fixed calibration pins and/or bushings). Installed calibration tools are not shown.

A fixed calibration pin and a bushing for the movable calibration tool are located on each axis as follows.

If there is not enough space on an axis to install a fixed calibration pin, the axis is equipped with two bushings instead, for installation of two calibration tools when calibration is carried out. This is shown in the figure.

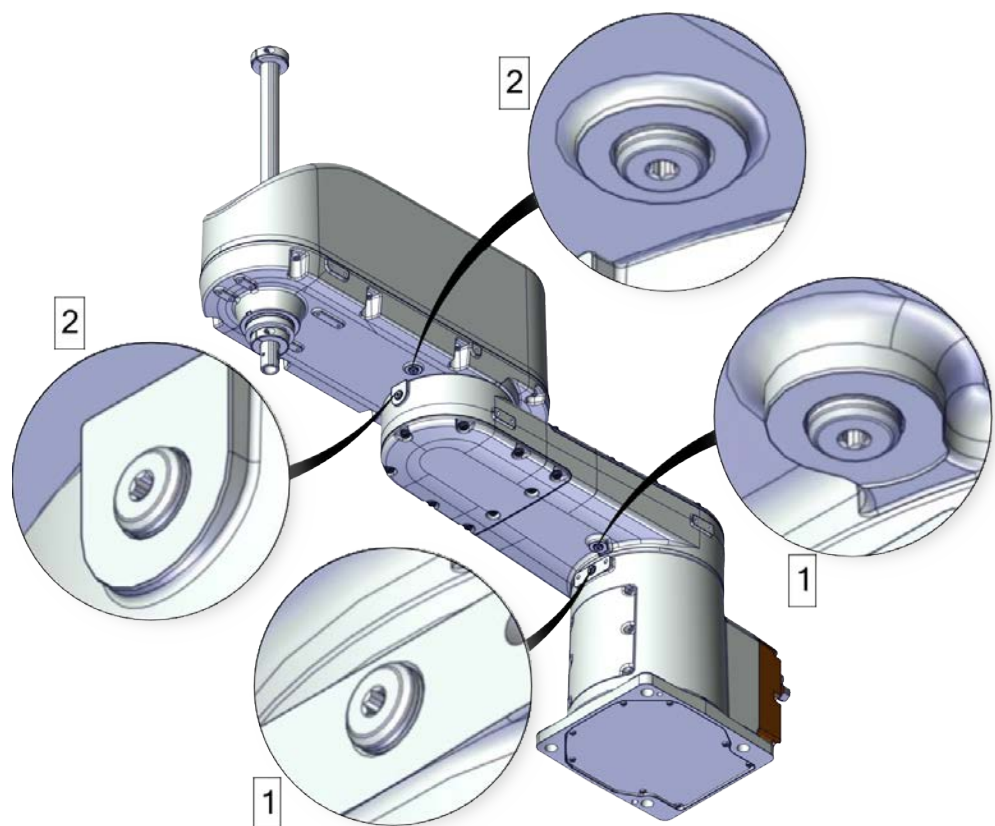

xx2000001164

Spare parts

When calibration is not being performed, a protective cover and an o-ring should always be installed on the fixed calibration pin as well as a protective plug, included a sealing, in the bushing. Replace damaged parts with new.

Spare part	Article number	Note
Protective plug for bushing	3HAC054431-005	Replace if damaged or missing.

6 Calibration

6.4.4 Axis Calibration - Running the calibration procedure

6.4.4 Axis Calibration - Running the calibration procedure

Required tools

The calibration tools used for Axis Calibration are designed to meet requirements for calibration performance, durability and safety in case of accidental damage.



WARNING

Calibrating the robot with Axis Calibration requires special calibration tools from ABB. Using other pins in the calibration holes may cause severe damage to the robot and/or personnel.

Equipment, etc.	Article number	Note
Calibration toolbox, Axis Calibration	3HAC055412-001	Delivered as a set of calibration tools. Required if Axis Calibration is the valid calibration method for the robot.

Required consumables

Consumable	Article number	Note
Clean cloth	-	

Spare parts

Spare part	Article number	Note
Protective plug for bushing	3HAC054431-005	Replace if damaged or missing.

Overview of the calibration procedure on the FlexPendant

The actual instructions of how to perform the calibration procedure and what to do at each step is given on the FlexPendant. You will be guided through the calibration procedure, step by step.

Use the following list to learn about the calibration procedure before running the RobotWare program on the FlexPendant. It gives you a brief overview of the calibration procedure.

After the calibration method has been started on the FlexPendant, the following sequence will be run.

- 1 Choose calibration routine. The routines are described in [Routines in the calibration procedure on page 957](#).
- 2 Choose which axis/axes to calibrate.
- 3 The robot moves to synchronization position.
- 4 Validate the synchronization marks.
- 5 The robot moves to preparation position.
- 6 Remove the protective cover from the fixed pin and the protection plug from the bushing, if any, and install the calibration tool.
- 7 The robot performs a measurement sequence by rotating the axis back and forth.

Continues on next page

6.4.4 Axis Calibration - Running the calibration procedure



Continued

- 8 Remove the calibration tool and reinstall the protective cover on the fixed pin and the protection plug in the bushing, if any.
- 9 The robot moves to verify that the calibration tool is removed.
- 10 Choose whether to save the calibration data or not.

Calibration of the robot is not finished until the calibration data is saved, as last step of the calibration procedure.

Preparation prior to calibration

The calibration procedure is described in the FlexPendant while conducting it.

	Action	Note
1	 DANGER While conducting the calibration, the robot needs to be connected to power. Make sure that the robot's working area is empty, as the robot can make unpredictable movements.	
2	Wipe the calibration tool clean.  Note The calibration method is exact. Dust, dirt or color flakes will affect the calibration value.	Use a clean cloth.

Starting the calibration procedure

Use this procedure to start the Axis Calibration routine on the FlexPendant.

	Action	Note
1	Tap the calibration icon and enter the calibration main page.	
2	All mechanical units connected to the system are shown with their calibration status. Tap the mechanical unit in question.  Note For RobotWare 7, the mechanical unit page is displayed only if there is more than one mechanical unit available.	
3	The calibration method used at ABB factory for each axis is shown, as well as calibration method used for the robot during last field calibration.	The FlexPendant will give all information needed to proceed with Axis Calibration.
4	Valid for RobotWare 7 Tap Calibration Methods on the right pane and then tap Calibration . The software will automatically call for the procedure for the valid calibration method.	

Continues on next page

6 Calibration

6.4.4 Axis Calibration - Running the calibration procedure

Continued

	Action	Note
5	Follow the instructions given on the FlexPendant.	A brief overview of the sequence that will be run on the FlexPendant is given in Overview of the calibration procedure on the FlexPendant on page 962 .

Restarting an interrupted calibration procedure

If the Axis Calibration procedure is interrupted before the calibration is finished, the RobotWare program needs to be started again. Use this procedure to take required action.

Situation	Action
The three-position enabling device on the FlexPendant has been released during robot movement.	Press and hold the three-position enabling device and press Play .
The RobotWare program is terminated with PP to Main .	Remove the calibration tool, if it is installed, and restart the calibration procedure from the beginning. See Starting the calibration procedure . If the calibration tool is in contact the robot axis needs to be jogged in order to release the calibration tool. Jogging the axis in wrong direction will cause the calibration tool to break. Directions of axis movement is shown in Calibration movement directions for all axes on page 951

Axis Calibration with SafeMove option

To be able to run Axis Calibration, SafeMove needs to be unsynchronized. The Axis Calibration routine recognizes if the robot is equipped with SafeMove and will force SafeMove to unsynchronize automatically.

However, SafeMove may generate other warning messages anytime during the Axis Calibration routine. When a warning message is displayed, tap **Acknowledge** to confirm the unsynchronized state and continue Axis Calibration procedure.



CAUTION

SafeMove must be synchronized after the calibration is completed.

Continues on next page

After calibration

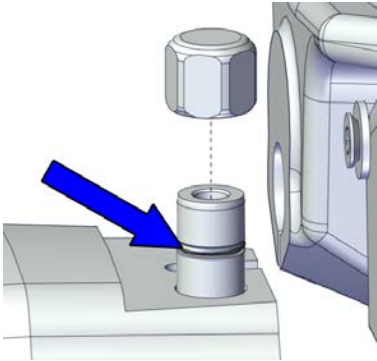
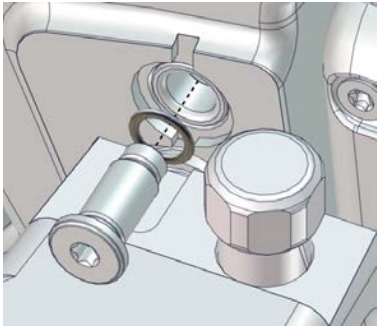
	Action	Note
1	Check the o-ring on the fixed calibration pin. Replace if damaged or missing.	 <p data-bbox="1059 725 1166 745">xx1600002102</p> <p data-bbox="1059 763 1394 815">Protection cover and plug set: 3HAC059487-001.</p>
2	Reinstall the protective cover on the fixed calibration pin on each axis, directly after the axis has been calibrated. Replace the cover with new spare part, if missing or damaged.	
3	Reinstall the protective plug and sealing in the bushing on each axis, directly after the axis has been calibrated. Ensure that the sealing is not damaged. Replace the plug and the sealing with new spare part, if missing or damaged.	 <p data-bbox="1059 1164 1166 1184">xx1500000952</p> <p data-bbox="1059 1202 1394 1254">Protection cover and plug set: 3HAC059487-001.</p>

6.4.5 Reference calibration

Brief introduction to Reference Calibration



Note

Only axes 1 and 2 of the IRB 920 can be calibrated with the reference calibration routine.

Reference calibration is a faster method compared to Fine calibration, as it refers to a previously made calibration.

- 1 Create a backup of the current robot system.
- 2 Check that the active calibration offset values corresponds to the values on the silver label (on the lower arm or the base).
- 3 Jog the manipulator so that all axes are in zero position (ex use `MoveAbsJ` instruction). Check that all axis scales are aligned with calibration marks.
- 4 If the scales differ from calibration marks it might depend on wrong turns of the revolution counters. Make a marker line on the corresponding axis to be able to validate the result of the calibration. If more than one motor revolutions are wrong, the calibration will fail.
- 5 Use a verification position. This is especially recommended if all axes were not aligned with the synchronization marks (step 3). Reuse an existing position that is suitable and accurate so it can be used to validate the repair. Use a position where a deviation in axis calibration gives a big deviation in positioning. Note! Check the position after each repair in one axis.
- 6 Use Reference calibration to save reference values for all axes that is to be replaced. Make sure that the values are saved in RobotStudio or FTP program. The files are located in "Active system folder name/HOME/RefCalibFiles".
- 7 Perform the repair.
- 8 Make sure that the tooling and process equipment are the same as when creating the reference. Use Reference calibration to update the system with new calibration offset value for the repaired axis.
- 9 Check the position against the verification position (step 5).
- 10 Proceed with the repair of the next axis, if necessary, and repeat (step 8-9) for every axis.
- 11 (For system containing SafeMove) Download new calibration values to SafeMove. Use Visual SafeMove in RobotStudio.
- 12 (For system containing SafeMove) Synchronize SafeMove to activate SafeMove.
- 13 Perform test run.
- 14 Update the label for resolver values with new calibration values.

Continues on next page

Manual tuning of calibration offset

Manual tuning of calibration offset is normally not needed, but can be useful in some situations. The requirement to do manual tuning is that there is a known accurate position, that worked accurately before the repair (step 5, see [Brief introduction to Reference Calibration on page 966](#)).

6 Calibration

6.5.1 Calibration position

6.5 Calibrating the robot

6.5.1 Calibration position

Calibration position

The table below specifies the axis positions.

Axis	
3	2 mm
4	0°

6.5.2 Calibrating axis 1 and axis 2

Calibrating axis 1 and axis 2

Axes 1 and 2 of the IRB 920 are calibrated using the Axis Calibration method. See [Calibrating with Axis Calibration method on page 956](#).

6 Calibration

6.5.3 Calibrating axis 3 and axis 4

6.5.3 Calibrating axis 3 and axis 4

Calibration position of axis 3 and axis 4

The figure shows axis 3 and axis 4 in calibration position. The axes 3 and 4 are calibrated together.

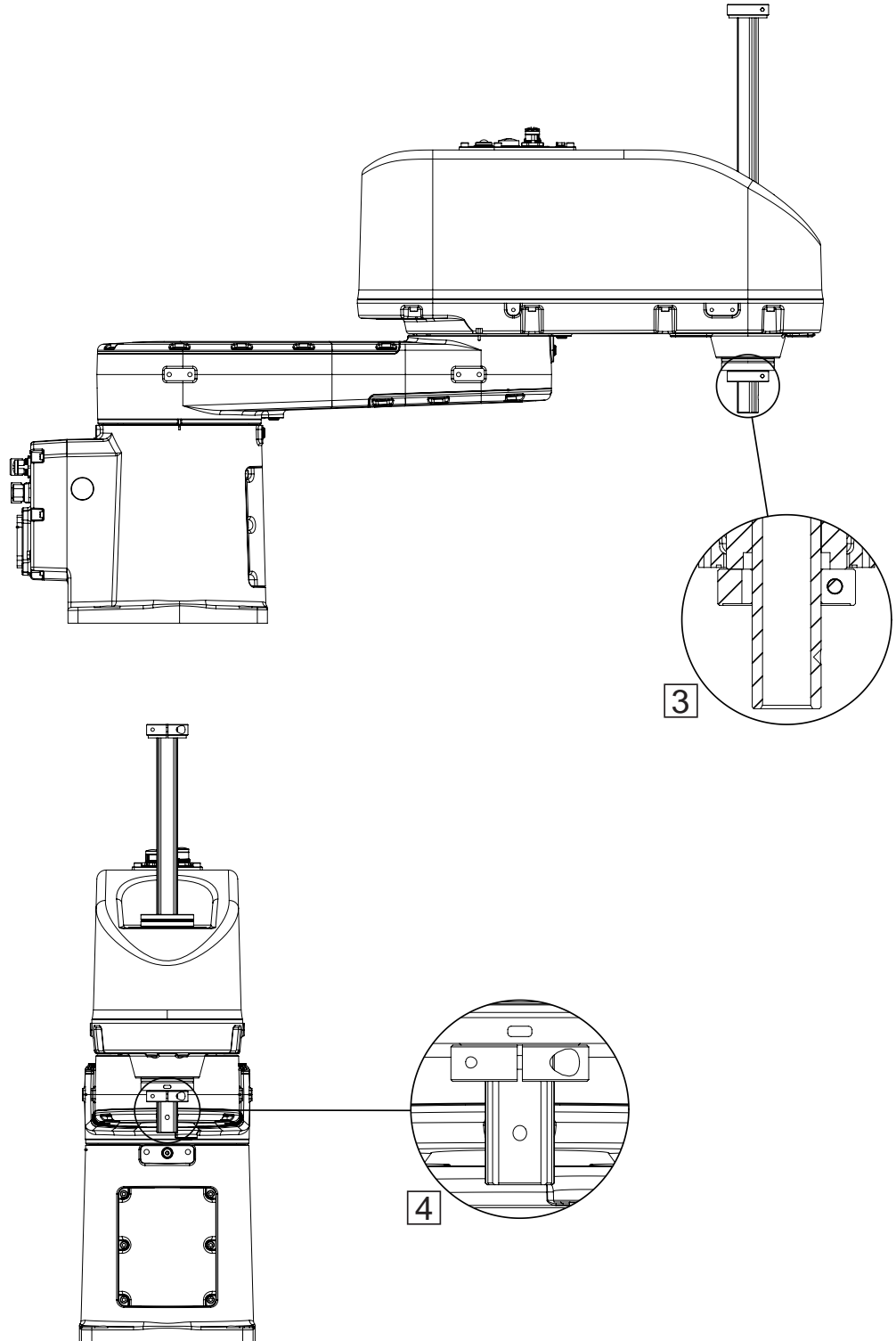

xx2000001165

Continues on next page

Required equipment

Axes 3 and 4 are calibrated together.



The axis-3 calibration is done by moving the ball screw spline unit so that the upper surface of the lower mechanical stopper and the lower surface of the ball screw lower nut touch each other gently.

The axis-4 calibration is done by rotating the ball screw spline unit so that the opening gap on the lower mechanical stopper or the ball screw origin point is aligned with the notch on the outer arm cover.

Required consumables

Equipment	Art. no.	Note
Cleaning agent	-	Isopropanol

Calibrating axis 3 and axis 4**Moving the robot to calibration position**

	Action	Note
1	 DANGER Turn off all: <ul style="list-style-type: none"> • electric power supply • hydraulic pressure supply • air pressure supply to the robot, before entering the robot working area.	
2	Remove the fitted extra equipment on the robot if it may cause a collision to the arm when push the ball screw to the calibration position.	
3	Turn on the electric power to the robot.	
4	 DANGER When releasing the holding brakes, the robot axes may move very quickly and sometimes in unexpected ways! Make sure the payload is disassembled or tooling is properly supported; otherwise, fast downward movements of axis 3 may cause severe hits.	

Continues on next page



6 Calibration

6.5.3 Calibrating axis 3 and axis 4

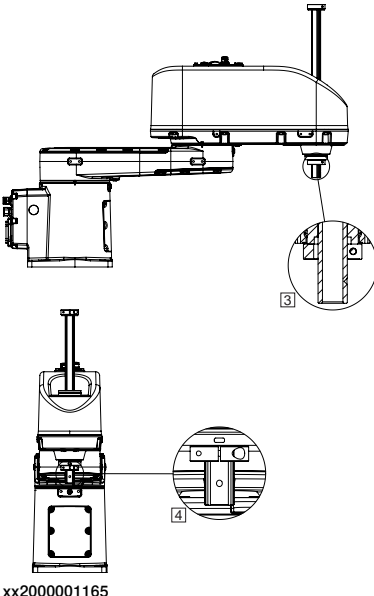
Continued

	Action	Note
5	Release the brakes and manually push axis 3 until the upper surface of the lower mechanical stopper touches the lower surface of the ball screw lower nut gently. There should be no pressing force between them. When doing this, pay attention to robot pose in order to avoid arm collision.	<p>How to release the brakes is detailed in Manually releasing the brakes on page 63.</p>  <p>xx2000001165</p>
6	Release the brakes and manually rotate axis 4 until the opening gap on the lower mechanical stopper or the ball screw origin point is aligned with the notch on the outer arm cover. When doing this, pay attention to robot pose in order to avoid arm collision.	
7	When the axes are in position, release the brake release button to activate the brakes again.	

Performing the fine calibration procedure

	Action	Note
1	On the start screen, tap Calibrate .	
2	Select Calibration from the menu. The Mechanical Units page displays a list of available mechanical units.  Note This step is required only if you are not already in the Mechanical Unit page when you open Calibrate .  Note The Mechanical Unit page is displayed only if there are more than one mechanical unit available. Otherwise, the calibration summary page for the available mechanical unit is displayed.	
3	Select the unit that needs to be calibrated from the Mechanical Unit list. The calibration summary for the selected mechanical unit is displayed.	
4	On the right pane tap Calibration Methods .	
5	Tap Calibration Parameters . The calibration parameters are displayed.	

Continues on next page

	Action	Note
6	<p>Tap Fine Calibration.</p> <p>A dialog box is displayed, urging you to use external equipment to perform the actual calibration. Make sure all necessary calibration equipment is fitted for the axis to be calibrated.</p> <p>A warning that performing fine calibration can change programmed robot positions is also displayed:</p> <ul style="list-style-type: none"> • Tap Yes to proceed. • Tap No to cancel. 	
7	Select the check-box for the current axis/axes to be calibrated.	
8	<p>Tap Calibrate.</p> <p>A dialog box is displayed, warning that calibration of the selected axes will be changed, which cannot be undone:</p> <ul style="list-style-type: none"> • Tap Calibrate to proceed. • Tap Cancel to cancel. <p>Tapping Calibrate results in briefly displaying a dialog box, announcing that the calibration process has started.</p> <p>The axis is calibrated and the system returns to the list of available mechanical units.</p>	
9	<p>Tap OK.</p> <p>The fine calibration process is complete.</p>	

Checking and finalizing the calibration

	Action	Note
1	 <p>DANGER</p> <p>Always remember to remove the calibration tools from the robot before jogging axes to zero position during calibration.</p>	
2	Release the brakes and manually rotate the axis to apart the calibration pins from each other. This is done to avoid damage on the pins if incorrect operation should occur during next step of jogging.	
3	Jog axes 3 and 4 to zero degree using the Flex-Pendant.	

Continues on next page

6 Calibration

6.5.3 Calibrating axis 3 and axis 4

Continued

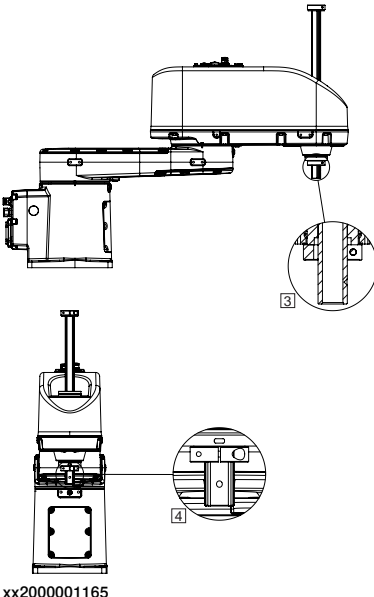
	Action	Note
4	<p>Check that the synchronization marks on axes 3 and 4 are aligned with each other.</p> <p>Are they aligned within the tolerances?</p> <ul style="list-style-type: none"> • If yes, the calibration is verified OK. • If no, redo the fine calibration procedure. 	 <p>xx2000001165</p>
5	Update the revolution counters of axes 3 and 4.	See Updating revolution counters on page 952 .

After calibration

	Action	Note
1	Write down the new system parameters on a new label and stick on top of the calibration label on the robot.	



Note

The calibration status of axis 3 may be changed to **Not updated** after a system reinstallation or warm restart. In this case, update the revolution counters for axis 3 and axis 4 (axis 4 is coupled with axis 3). See [Updating revolution counters on page 952](#).

6.6 Verifying the calibration

Introduction

Always verify the results after calibrating *any* robot axis to verify that all calibration positions are correct.

Verifying the calibration

Use this procedure to verify the calibration result.

	Action	Note
1	Run the calibration home position program twice. Do not change the position of the robot axes after running the program!	See Checking the synchronization position on page 976 .
2	Adjust the <i>synchronization marks</i> when the calibration is done, if necessary.	This is detailed in section Synchronization marks and synchronization position for axes on page 949 .
3	Write down the values on a new label and stick it on top of the calibration label. The label is located on the base.	

6 Calibration

6.7 Checking the synchronization position

6.7 Checking the synchronization position

Introduction

Check the synchronization position of the robot before beginning any programming of the robot system. This may be done:

- Using a `MoveAbsJ` instruction with argument zero on all axes.
- Using the **Jog** window on the FlexPendant.

Using a `MoveAbsJ` instruction

Use this procedure to create a program that runs all the robot axes to their synchronization position.

	Action	Note
1	Tap Code .	
2	Create a new program.	
3	Use MoveAbsJ in the Add Instruction menu.	
4	Create the following program: <pre>MoveAbsJ [[0,0,0,0,0,0], [9E9,9E9,9E9,9E9,9E9,9E9]] \NoEOffs, v1000, fine, tool0</pre>	
5	Run the program in manual mode.	
6	Check that the synchronization marks for the axes align correctly. If they do not, update the revolution counters.	See Synchronization marks and synchronization position for axes on page 949 and Updating revolution counters on page 952 .

Using the jogging window

Use this procedure to jog the robot to the synchronization position of all axes.

	Action	Note
1	Tap Jog .	
2	From the Mechanical unit list select a mechanical unit.	
3	From the Motion mode section, select an axis-set that need to be jogged. For example, to jog axis 2, select the axis set Axis 1-3 .	
4	Follow the screen instruction on joystick movements to understand the direction of the axis that you want to move and move the joystick.	
5	Manually run the robots axes to a position where the axis position value read on the FlexPendant, is equal to zero.	
6	Check that the synchronization marks for the axes align correctly. If they do not, update the revolution counters.	See Synchronization marks and synchronization position for axes on page 949 and Updating revolution counters on page 952 .

7 Troubleshooting

7.1 Introduction to troubleshooting

Introduction

The product manual and the circuit diagram contains information that can be good when troubleshooting.

For OmniCore, all event logs from the software can be seen on the FlexPendant, or in *Technical reference manual - Event logs for RobotWare 7*.

Make sure to read through the section [Safety on page 15](#) before starting.

Troubleshooting strategies

- 1 Isolate the fault to pinpoint the cause of the problem from consequential problems.
- 2 Divide the fault chain in two.
- 3 Check communication parameters and cables.
- 4 Check that the software version is compatible with the hardware.

Work systematically

- 1 Take a look around to make sure that all screws, connectors, and cables are secured, and that the robot and other parts are clean, not damaged, and correctly fitted.
- 2 Replace one thing at a time.
- 3 Do not replace units randomly.
- 4 Make sure that there are no loose screws, turnings, or other unexpected parts remaining after work has been performed.
- 5 When the work is completed, verify that the safety functions are working as intended.

Keep a track of history

- Make a historical fault log to keep track of problems over time.
- Consult those working with the robot when the problem occurred.

Basic scenarios

What to look for during troubleshooting depends on when the fault occurred. Was the robot recently installed or was it recently repaired? The following table gives hints on what to look for in specific situations.

The robot has recently been installed	Check: <ul style="list-style-type: none"> • the configuration files • connectors • options and their configuration • changes in the robot working space/movements.
---------------------------------------	--

Continues on next page

7 Troubleshooting

7.1 Introduction to troubleshooting

Continued

The robot has recently been repaired	Check: <ul style="list-style-type: none">• all connections to the replaced part• power supplies• that the correct part has been fitted• the last repair documents.
The robot recently had a software upgrade	Check: <ul style="list-style-type: none">• software versions• compatibilities between hardware and software• options and their configuration
The robot has recently been moved from one site to another (an already working robot)	Check: <ul style="list-style-type: none">• connections• software versions

7.2 Oil and grease stains on motors and gearboxes

Description

The area surrounding the motor, gearbox or seal lip shows signs of oil leaks. This can be at the base, closest to the mating surface, at the furthest end of the motor at the resolver, or around the joints of the covers (closest to the edge) on the robot surface.

Consequences

Besides the dirty appearance, in most cases there are no serious consequences if the leaked amount of oil is very small.

Possible causes

The symptom can be caused by:

- Leakage of rust preventives or mounting grease. This should be wiped off.
- Leaking sealing between gearbox and motor.
- Gearbox overfilled with oil.
- Gearbox oil too hot.

Recommended actions

The following actions are recommended:

	Action	Information
1	 CAUTION Allow hot parts to cool down.	
2	Wipe off the oil or grease, see Cleaning the IRB 920 on page 108 . Monitor the robot over time to see if new oil or grease occurs.	If the oil spill is small, this step is sufficient.
3	Check the gearbox oil level.	
4	Too hot gearbox oil may be caused by: <ul style="list-style-type: none"> • Incorrect oil quality or level. • The robot work cycle runs a specific axis too hard. Investigate whether it is possible to program small "cooling periods" into the application. • Overpressure created inside gearbox. 	Robots performing certain, extremely heavy duty work cycles may be fitted with vented oil plugs. These are not fitted to normal duty robots, but can be purchased from your local ABB representative.
5	Inspect all sealings and gaskets between motor and gearbox. Replace broken parts.	

7 Troubleshooting

7.3 Mechanical noise or dissonance

7.3 Mechanical noise or dissonance

Description

Mechanical noise or dissonance that has not been observed before can indicate problems in bearings, motors, gearboxes, or similar. Be observant of changes over time.

A faulty bearing often emits scraping, grinding, or clicking noises shortly before failing.

A humming resonance sound can occur without being an error. Mechanical resonance sound is a physical phenomenon in mechanical structures. It has no impact on product performance or lifetime. Adjusting the robot movement speed out of the range that causes the resonance will eliminate the sound.

Consequences

Failing bearings cause the path accuracy to become inconsistent, and in severe cases, the joint can seize completely.

Possible causes

The symptom can be caused by:

- Worn bearings.
- Contaminations have entered the bearing grooves.
- Loss of lubrication in bearings.
- Loss of lubrication in ball screw.
- Loose heat sinks, fans, or metal parts.

If the noise is emitted from a gearbox, the following can also apply:

- Overheating.

Recommended actions

The following actions are recommended:

	Action	Information
1	 CAUTION Allow hot parts to cool down.	
2	Verify that the service is done according to the maintenance schedule.	
3	If a bearing is emitting the noise, determine which one and make sure that it has sufficient lubrication.	
4	If possible, disassemble the joint and measure the clearance.	
5	Bearings inside motors are not to be replaced individually, but the complete motor is replaced.	
6	Make sure the bearings are fitted correctly.	

Continues on next page

	Action	Information
7	Tighten the screws if a heat sink, fan, or metal sheet is loose.	

7 Troubleshooting

7.4 Manipulator collapses on power down

7.4 Manipulator collapses on power down

Description

The manipulator is able to work correctly while Motors ON is active, but when Motors OFF is active, one or more axes drops or collapses under its own weight. The holding brakes (normally one in each motor), is not able to hold the weight of the manipulator arm.

Consequences

For a heavy robot, the collapse can cause severe injury to personnel working in the area or severe damage to the robot and/or surrounding equipment.

For a small robot, the collapse can cause injury to personnel working close to the robot or damage to the robot and/or surrounding equipment.

Possible causes

The symptom can be caused by:

- Faulty brake.
 - Faulty power supply to the brake.
-

Recommended actions

The following actions are recommended:

	Action	Information
1	Determine which motor(s) causes the robot to collapse.	
2	Check the brake power supply to the collapsing motor during the Motors OFF state.	See the circuit diagram.
3	Remove the resolver or resolver cover of the motor to see if there are any signs of oil leaks.	If found faulty, the motor must be replaced as a complete unit.
4	Remove the motor from the gearbox to inspect it from the drive side.	If found faulty, the motor must be replaced as a complete unit.

7.5 Motor temperature too high

Description

The robot stops and the motor temperature for joint arg is too high.

Consequences

It is not possible to continue until the motor has cooled down. The system goes to Motors Off.

Possible causes

The symptom can be caused by:

- The values for payload and arm load are not consistent with the actual ones.
- The value for ambient temperature setting in the controller is not consistent with the actual operating temperature environment.
- The user program may contain too much high acceleration and deceleration of the joint.
- Gravity torque or external forces for the joint can also be too high.

Recommended actions

The following actions are recommended:

	Action	Information
1	 CAUTION Allow hot parts to cool down.	
2	Verify that the values for payload and arm load are set correctly.	
3	Verify that the value for ambient temperature setting in the controller is consistent with the actual operating temperature environment.	
4	Rewrite the user program to reduce the motor utilization.	The ways could be but not limited to optimizing robot movement cycle, adjusting acc, dec as well as external force, adding wait time, and introducing alternative path/RAPID, etc.

This page is intentionally left blank

8 Decommissioning

8.1 Introduction to decommissioning

Introduction

This section contains information to consider when taking a product, robot or controller, out of operation.

It deals with how to handle potentially dangerous components and potentially hazardous materials.



Note

The decommissioning process shall be preceded by a risk assessment.

General

All used grease/oils and dead batteries **must** be disposed of in accordance with the current legislation of the country in which the robot and the control unit are installed.

If the robot or the control unit is partially or completely disposed of, the various parts **must** be grouped together according to their nature (which is all iron together and all plastic together), and disposed of accordingly. These parts **must** also be disposed of in accordance with the current legislation of the country in which the robot and control unit are installed.

8 Decommissioning

8.2 Environmental information

8.2 Environmental information

Introduction

ABB robots contain components in different materials. During decommissioning, all materials should be dismantled, recycled, or reused responsibly, according to the relevant laws and industrial standards. Robots or parts that can be reused or upcycled helps to reduce the usage of natural resources.

Symbol

The following symbol indicates that the product must not be disposed of as common garbage. Handle each product according to local regulations for the respective content (see table below).

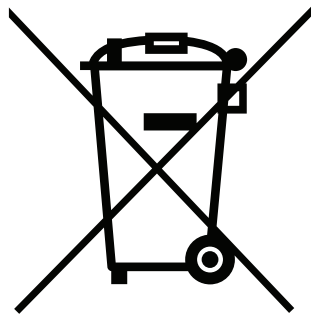

xx1800000058

Materials used in the product

The table specifies some of the materials in the product and their respective use throughout the product.

Dispose components properly according to local regulations to prevent health or environmental hazards.

Material	Example application
Aluminium	Structural parts, motors, covers
Batteries, Lithium	Battery unit
Copper	Cables, motors
Magnesium	Cover
Neodymium	Brakes, motors
Oil, grease	Drive units, ball screw spline unit, cables
Plastic/rubber	Mechanical stop rubber, seals, cables, pulley protection cover, resolver cover, VK cover, and etc
Stainless steel	Sheet metal
Steel	Drive units, ball screw spline unit, screws, and etc

Continues on next page

China RoHS symbol

The following symbol shows the information to hazardous substances and the environmental protection use period of IRB 920 according to "Management Methods for the Restriction of the Use of Hazardous Substances in Electrical and Electronic Products (SJ/T 11364-2014)".

Oil and grease

Where possible, arrange for oil and grease to be recycled. Dispose of via an authorized person/contractor in accordance with local regulations. Do not dispose of oil and grease near lakes, ponds, ditches, down drains, or onto soil. Incineration must be carried out under controlled conditions in accordance with local regulations.

Also note that:

- Spills can form a film on water surfaces causing damage to organisms. Oxygen transfer could also be impaired.
- Spillage can penetrate the soil causing ground water contamination.

8 Decommissioning

8.3 Scrapping of robot

8.3 Scrapping of robot



Note

The decommissioning process shall be preceded by a risk assessment.

Important when scrapping the robot



DANGER

The risk assessment should consider hazards arising in the decommissioning, such as, but not limited to:

- Always remove all batteries. If a battery is exposed to heat, for example from a blow torch, it will explode.
- Always remove all oil/grease in gearboxes. If exposed to heat, for example from a blow torch, the oil/grease will catch fire.
- When motors are removed from the robot, the robot will collapse if it is not properly supported before the motor is removed.
- A used robot does not have the same performance as on delivery. Springs, brakes, bearings, and other parts might be worn or broken.

9 Reference information

9.1 Introduction

General

This chapter includes general information, complementing the more specific information in the different procedures in the manual.

9 Reference information

9.2 Applicable standards

9.2 Applicable standards

General

The product is compliant with ISO 10218-1:2011, *Robots for industrial environments - Safety requirements - Part 1 Robots*, and applicable parts in the normative references, as referred to from ISO 10218-1:2011. In case of deviation from ISO 10218-1:2011, these are listed in the declaration of incorporation. The declaration of incorporation is part of the delivery.

Robot standards

Standard	Description
ISO 9283	Manipulating industrial robots – Performance criteria and related test methods
ISO 9787	Robots and robotic devices – Coordinate systems and motion nomenclatures
ISO 9946	Manipulating industrial robots – Presentation of characteristics

Other standards used in design

Standard	Description
IEC 60204	Safety of machinery - Electrical equipment of machines - Part 1: General requirements, normative reference from ISO 10218-1
IEC 61000-6-2	Electromagnetic compatibility (EMC) – Part 6-2: Generic standards – Immunity standard for industrial environments
IEC 61000-6-4	Electromagnetic compatibility (EMC) – Part 6-4: Generic standards – Emission standard for industrial environments
ISO 13849-1:2006	Safety of machinery - Safety related parts of control systems - Part 1: General principles for design, normative reference from ISO 10218-1
IEC 61340-5-1	Protection of electronic devices from electrostatic phenomena - General requirements

Region specific standards and regulations

Standard	Description
ANSI/RIA R15.06	Safety requirements for industrial robots and robot systems
ANSI/UL 1740	Safety standard for robots and robotic equipment
CAN/CSA Z 434-03	Industrial robots and robot Systems - General safety requirements
ANSI/ESD S20.20	Protection of Electrical and Electronic Parts, Assemblies and Equipment (Excluding Electrically Initiated Explosive Devices)
EN ISO 10218-1	Robots and robotic devices — Safety requirements for industrial robots — Part 1: Robots

9.3 Unit conversion

Converter table

Use the following table to convert units used in this manual.

Quantity	Units		
Length	1 m	3.28 ft.	39.37 in
Weight	1 kg	2.21 lb.	
Weight	1 g	0.035 ounces	
Pressure	1 bar	100 kPa	14.5 psi
Force	1 N	0.225 lbf	
Moment	1 Nm	0.738 lbf-ft	
Volume	1 L	0.264 US gal	

9 Reference information

9.4 Screw joints

9.4 Screw joints

General

This section describes how to tighten the various types of screw joints on ABB robots.

The instructions and torque values are valid for screw joints comprised of metallic materials and do *not* apply to soft or brittle materials.

UNBRAKO screws

UNBRAKO is a special type of screw recommended by ABB for certain screw joints. It features special surface treatment (Gleitmo as described below) and is extremely resistant to fatigue.

Whenever used, this is specified in the instructions, and in such cases, *no other type of replacement screw* is allowed. Using other types of screws will void any warranty and may potentially cause serious damage or injury.

Gleitmo treated screws

Gleitmo is a special surface treatment to reduce the friction when tightening the screw joint. It is recommended by ABB for M6-M20 screw joints. Screws treated with Gleitmo may be reused 3-4 times before the coating disappears. After this the screw must be discarded and replaced with a new one.

When handling screws treated with Gleitmo, protective gloves of nitrile rubber type should be used.

Generally, screws are lubricated with *Gleitmo 603* mixed with *Geomet 500* or *Geomet 702* in proportion 1:3. *Geomet* thickness varies according to screw dimensions, refer to the following.

Dimension	Lubricant	Geomet thickness
M6-M20 (any length except M20x60)	<i>Gleitmo 603 + Geomet 500</i>	3-5 µm
M6-M20 (any length except M20x60)	<i>Gleitmo 603 + Geomet 720</i>	3-5 µm
M20x60	<i>Gleitmo 603 + Geomet 500</i>	8-12 µm
M20x60	<i>Gleitmo 603 + Geomet 720</i>	6-10 µm

Screws lubricated in other ways

Screws lubricated with Molykote 1000 or Molykote P1900 should *only* be used when specified in the repair, maintenance or installation procedure descriptions.

In such cases, proceed as follows:

- 1 Apply lubricant to the screw thread.
- 2 Apply lubricant between the plain washer and screw head.
- 3 Screw dimensions of M8 or larger must be tightened with a torque wrench. Screw dimensions of M6 or smaller may be tightened without a torque wrench *if* this is done by trained and qualified personnel.

Continues on next page

Lubricant	Article number
Molykote 1000 (molybdenum disulphide grease)	3HAC042472-001
Molykote P1900 (molybdenum disulphide grease)	3HAC070875-001

Tightening torque

Before tightening any screw, note the following:

- Determine whether a **standard** tightening torque or **special** torque is to be applied. The **standard torques** are specified in the following tables. Any **special torques** are specified in the repair, maintenance or installation procedure descriptions. **Any special torque specified overrides the standard torque!**
- Use the *correct tightening torque* for each type of screw joint.
- Only use *correctly calibrated* torque keys.
- *Always tighten the joint by hand*, and never use pneumatic tools.
- Use the *correct tightening technique*, that is *do not* jerk. Tighten the screw in a slow, flowing motion.
- Maximum allowed total deviation from the specified value is **10%!**

Oil-lubricated screws with slotted or cross-recess head screws

The following table specifies the recommended standard tightening torque for *oil-lubricated screws with slotted or cross-recess head screws*.



Note

A special torque specified in the repair, maintenance or installation procedure overrides the standard torque.

Oil-lubricated screws with allen head screws

The following table specifies the recommended standard tightening torque for *oil-lubricated screws with allen head screws*.



Note

A special torque specified in the repair, maintenance or installation procedure overrides the standard torque.

Dimension	Tightening torque (Nm) Class 8.8, oil-lubricated	Tightening torque (Nm) Class 10.9, oil-lubricated	Tightening torque (Nm) Class 12.9, oil-lubricated
M5	6	-	-
M6	10	-	-
M8	24	34	40
M10	47	67	80
M12	82	115	140
M16	200	290	340
M20	400	560	670

Continues on next page

9 Reference information

9.4 Screw joints

Continued

Dimension	Tightening torque (Nm) Class 8.8, oil-lubricated	Tightening torque (Nm) Class 10.9, oil-lubricated	Tightening torque (Nm) Class 12.9, oil-lubricated
M24	680	960	1150

Lubricated screws (Molykote, Gleitmo or equivalent) with allen head screws

The following table specifies the recommended standard tightening torque for *screws lubricated with Molykote 1000, Gleitmo 603 or equivalent with allen head screws.*



Note

A special torque specified in the repair, maintenance or installation procedure overrides the standard torque.

Dimension	Tightening torque (Nm) Class 10.9, lubricated ⁱ	Tightening torque (Nm) Class 12.9, lubricated ⁱ
M8	28	35
M10	55	70
M12	96	120
M16	235	300
M20	460	550
M24	790	950

ⁱ Lubricated with Molykote 1000, Gleitmo 603 or equivalent

9.5 Weight specifications

Definition

In installation, repair, and maintenance procedures, weights of the components handled are sometimes specified. All components exceeding 22 kg (50 lbs) are highlighted in this way.

To avoid injury, ABB recommends the use of a lifting accessory when handling components with a weight exceeding 22 kg. A wide range of lifting accessories and devices are available for each manipulator model.

Example

Following is an example of a weight specification in a procedure:

	Action	Note
	 CAUTION The arm weighs 25 kg. All lifting accessories used must be sized accordingly.	

9 Reference information

9.6 Standard toolkit

9.6 Standard toolkit

General

All service (repairs, maintenance, and installation) procedures contains lists of tools required to perform the specified activity.

All special tools required are listed directly in the procedures while all the tools that are considered standard are gathered in the standard toolkit and defined in the following table.

This way, the tools required are the sum of the standard toolkit and any tools listed in the instruction.

Contents, standard toolkit

Qty	Tool	Rem.
1	Socket head cap 2-17 mm	
1	Torque wrench 0.3-45 Nm	
1	Torque wrench 56 Nm \pm 5.6 Nm	For securing robot to foundation.
1	Small screwdriver	
1	T-handle with ball head	
1	Small cutting plier	
1	Plastic mallet	

9.7 Special tools

General

All service instructions contain lists of tools required to perform the specified activity. The required tools are a sum of standard tools, defined in the section [Standard toolkit on page 996](#), and of special tools, listed directly in the instructions and also gathered in this section.

Special tools



Note

If the replacing procedure is not listed in the table below, only standard tools are needed for the procedure.

Continues on next page

9 Reference information

9.7 Special tools

Tools and equipment with spare part number: (These tools can be ordered from ABB)	
-	24 VDC power supply
3HAC055412-001	Calibration toolbox, Axis Calibration Delivered as a set of calibration tools. Required if Axis Calibration is the valid calibration method for the robot.
-	Sonic tension meter Used for measuring the timing belt tension.
-	Dynamometer Used for measuring the timing belt tension.
3HAC077249-001	IRB 920 special tool Used to install the ball screw nut. Special tool for L2

Continues on next page

9.8 Lifting accessories and lifting instructions

General

Many repair and maintenance activities require different pieces of lifting accessories, which are specified in each procedure.

The use of each piece of lifting accessories is *not* detailed in the activity procedure, but in the instruction delivered with each piece of lifting accessories.

The instructions delivered with the lifting accessories should be stored for later reference.

This page is intentionally left blank

10 Spare parts

10.1 Spare part lists and illustrations

Location

Spare parts and exploded views are not included in the manual but delivered as a separate document for registered users on myABB Business Portal, www.abb.com/myABB.



Tip

All documents can be found via myABB Business Portal, www.abb.com/myABB.

This page is intentionally left blank

Index

A

Absolute Accuracy, calibration, 947
 allergenic material, 26
 aluminum
 disposal, 986
 ambient humidity
 operation, 40
 storage, 40
 ambient temperature
 operation, 40
 storage, 40
 assembly instructions, 51
 assessment of hazards and risks, 26
 Axis Calibration, 956
 calibration tool
 article number, 959, 962
 examining, 959
 installation position, 961
 overview of method, 956
 procedure on FlexPendant, 962
 protective cover and protection plug, 961–962

B

ball screw spline unit
 lubrication, 106
 batteries
 disposal, 986
 Brake power supply, faulty, 982
 brake releasing, 63
 brakes
 testing function, 34

C

cabinet lock, 27
 cabling between robot and controller, 78
 calibrating
 robot, 956
 roughly, 952
 calibrating robot, 956
 calibration
 Absolute Accuracy type, 946
 rough, 952
 standard type, 946
 verification, 975
 when to calibrate, 948
 calibration, Absolute Accuracy, 947
 calibration manuals, 947
 calibration marks, 949
 calibration position
 jogging to, 976
 scales, 949
 calibration scales, 949
 CalibWare, 946
 carbon dioxide extinguisher, 27
 cleaning, 108
 climbing on robot, 30
 connecting the robot and controller, cabling, 78
 copper
 disposal, 986

D

damaged bearings, 980
 dimensions
 robot, 72

direction of axes, 951

E

environmental information, 986
 equipment, robot, 72
 ESD
 damage elimination, 49
 sensitive equipment, 49
 expected life, 90
 extra equipment, 72

F

faulty brake, 982
 fire extinguishing, 27
 fitting, equipment, 72
 FlexPendant
 jogging to calibration position, 976
 MoveAbsJ instruction, 976
 updating revolution counters, 955
 foundation
 requirements, 39

G

grease, 30
 disposal, 986

H

hanging
 installed hanging, 26
 hazard levels, 17
 hazardous material, 986
 height
 installed at a height, 26
 hot gearbox oil, 979–980
 hot surfaces, 30
 HRA, 26
 humidity
 operation, 40
 storage, 40

I

information labels location, 91
 inspecting
 information labels, 91
 robot cabling, 93
 timing belts, 100
 installation
 equipment, 72
 installation procedure, 55
 instructions for assembly, 51
 integrator responsibility, 26
 intervals for maintenance, 88

L

labels
 robot, 19
 leak-down test, 112
 leaking sealing, 979
 lifting
 robot, 57
 lifting accessory, 995
 limitation of liability, 15
 Lithium
 disposal, 986
 loads on foundation, 38
 lock and tag, 27
 lubricants, 30

lubrication
ball screw spline unit, 106

M

magnesium
disposal, 986
main harness
replacing, 120
maintenance intervals, 88
maintenance schedule, 88
mechanical stop
axis 1, 76
mechanical stop location, 76–77
mounting, equipment, 72
MoveAbsJ instruction, 976

N

national regulations, 26
negative directions, axes, 951
neodymium
disposal, 986
noise, 980

O

oil, 30
disposal, 986
oil leaks, 979
operating conditions, 40
original spare parts, 15
overfilled gearbox, 979

P

pedestal
installed on pedestal, 26
personnel
requirements, 16
plastic
disposal, 986
positive directions, axes, 951
PPE, 16
product standards, 990
protection classes, 40
protection type, 40
protective equipment, 16
protective wear, 16

R

recycling, 986
regional regulations, 26
release brakes, 33
replacements, report, 111
replacing
mechanical stop
axis 1, 76
xx, 53, 175, 193, 203, 398, 436, 454, 488, 601, 626
report replacements, 111
requirements on foundation, 39
responsibility and validity, 15
revolution counters
storing on FlexPendant, 955
updating, 952
risk of burns, 30
robot
dimensions, 72
equipment, fitting, 72
labels, 19
lifting, 57

protection class, 40
protection types, 40
symbols, 19
technical data, 38
working range, 44

robot cabling
inspecting, 93
rubber
disposal, 986

S

safety
brake testing, 34
ESD, 49
fire extinguishing, 27
release robot axes, 33
signals, 17
signals in manual, 17
symbols, 17
symbols on robot, 19
test run, 56
safety devices, 27
safety hazard
hydraulic system, 28
pneumatic system, 28
safety signals
in manual, 17
safety standards, 990
scales on robot, 949
schedule of maintenance, 88
screw joints, 992
securing, robot, 65
securing the robot to foundation, attachment screws, 65
signals
safety, 17
stainless steel
disposal, 986
standards, 990
ANSI, 990
CAN, 990
steel
disposal, 986
storage conditions, 40
symbols
safety, 17
synchronization position, 952
sync marks, 949
system integrator requirements, 26

T

technical data
robot, 38
temperatures
operation, 40
storage, 40
testing
brakes, 34
timing belts
inspecting, 100
torques on foundation, 38
troubleshooting
safety, 35

U

upcycling, 986
updating revolution counters, 952
users

requirements, 16

V

validity and responsibility, 15

verifying calibration, 975

W

weight, 38

robot, 60, 65

working range, 47

robot, 44

X

xx

replacing, 53, 175, 193, 203, 398, 436, 454, 488, 601, 626

Z

zero position

checking, 976